

# SMD COMMON MODE LINE FILTER

## CM02 SERIES

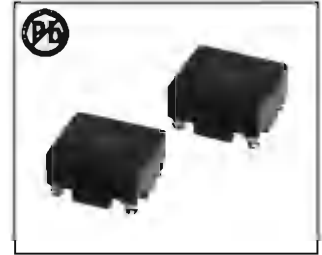

### FEATURES:

- Ferrite Core bobbin construction
- High frequency and Large current
- Excellent Mechanical Strength
- Excellent Solderability
- Excellent Frequency performance
- Low Profile and Low cost

### COMMON APPLCATIONS:

- Video Cameras
- Communication System
- Automotive Systems
- Liquid Crystal Televisions
- Hard Disk Drives
- Network Systems
- Computer Peripheral Equipment

### ELECTRICAL CHARACTERISTICS@25°C

Part Number	Inductance (uH) Typ.	Impedance (Ω) ± 25% @ 100MHz	Rated current (A)	DCR (mΩ)Max
CM02-501M	5.0	500	5.0	5.5
CM02-801M	9.0	800	3.5	13.2
CM02-102M	11.0	1000	2.5	30.0

### TECHNICAL INFORMATION & PHYSICAL CHARACTERISTICS

Dimensions(mm)

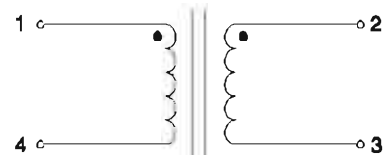
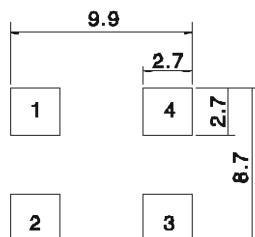
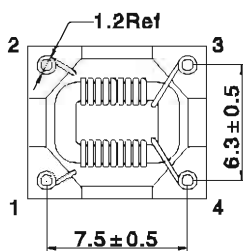
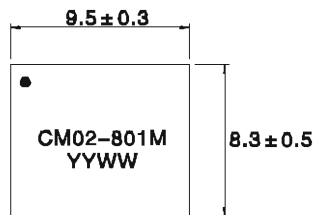

Note:

- Inductance Testing: 1KHz 1V HP4284A
- Z test with HP4191A or HP4395A
- RDC:QuadTech 1880 Milliohmmeter
- Operating temperature: -40°C to +105°C
- Storage Temperature: -40°C to +105°C
- Resistance to soldering heat:260°C for 10 seconds
- Marking: Part number and date code

Note:All specifications subject to change without notice.

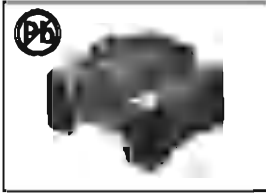

# COMMON MODE CHOKES FOR LINE FILTER

## CM4001 SERIES

### FEATURES:

- Current rating up to 1.4A
- Inductance range: 120 to 5000uH
- Frequency range to 200 MHz
- RoHS compliant

### OPTIONS:

- Packaging: Tape & Reel is standard
- Bulk packaging available for smaller quantities

### COMMON APPLICATIONS:

- EMI suppression
- DC-DC Converter
- Input/Output line filter
- RFI noise suppression

## ELECTRICAL CHARACTERISTICS:

Part Number	L(0A) μH ± 40%	Lk uH(Max)	DCR(Ω) each winding	Impedance(Z)		Rated voltage (Vdc)	Rated current (A)
				Freq. range (MHz)	Min Value (Ω)		
CM4001-121Y	120	1.45	0.025	10-200	200	50	1.40
CM4001-251Y	250	3.2	0.035	5-100	400	50	1.19
CM4001-501Y	500	5.6	0.070	2-50	800	50	0.84
CM4001-102Y	1000	12	0.180	1-40	1400	50	0.52
CM4001-202Y	2000	0.23	0.270	0.5-15	2000	50	0.40
CM4001-302Y	3000	0.26	0.330	0.5-10	3000	50	0.35
CM4001-402Y	4000	0.27	0.550	0.5-5	4000	50	0.30
CM4001-472Y	4700	0.28	1.000	0.6-3	6200	50	0.25
CM4001-502Y	5000	0.29	0.620	0.5-3	5000	50	0.25

## SCHEMATIC

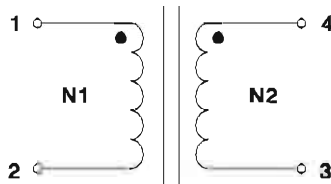

### NOTES:

1. Temperature Rise: 45°C at rated current
2. HI-Pot: 1000 Vrms, 60Hz, 3mA, 1min  
 @ 120-1000uH  
 300 Vrms, 60Hz, 3mA, 1min  
 @ 2000-5000uH
3. Operating Temperature:  
 -40°C to +105°C (Temperature rise included)
4. Storage Temperature:  
 -40°C to +105°C  
 Solderability: 245°C for 5 sec
5. Core Material ..... Ferrite
6. Base ..... Phenolic
7. Wire ..... Enamelled copper
8. Terminal coating ..... Sn
9. Packaging ..... 800 pcs. per 13-Inch reel

## PHYSICAL CHARACTERISTICS(Dimensions:mm)

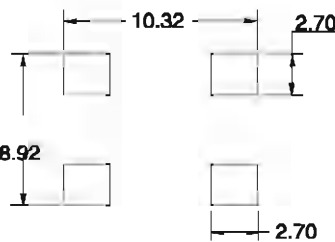
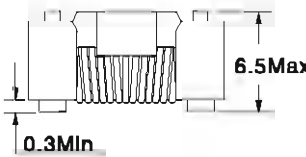
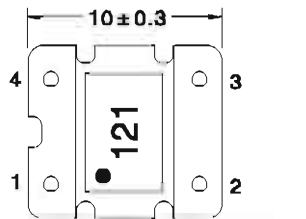

Recommended Layout

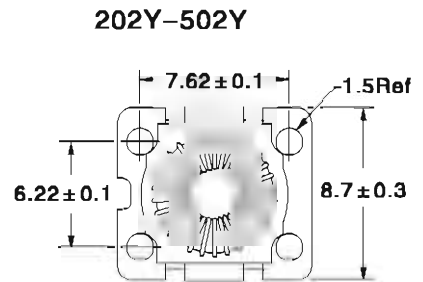
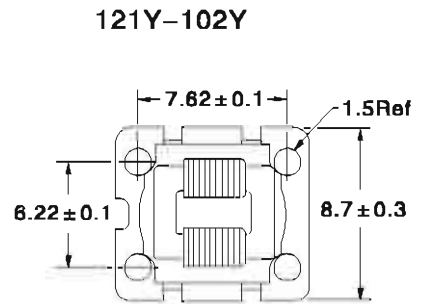

Note: All specifications subject to change without notice.



# SMD Line Filter SF0502 SERIES

### FEATURES:

- Current rating up to 8 A
- Impedance range: 100 to 1400MHz
- RoHS compliant

### APPLICATIONS:

- EMI suppression
- Power line equipment
- Portable equipment

## ELECTRICAL CHARACTERISTICS:@25°C

Part Number	Inductance (uH)Ref	Impedance Z(Ω) Typ 100MHz	Rated current (mA)	DCR (mΩ).	Rated voltage (Vdc)
SF0502-101Y	0.4	100	6000	9 ± 40%	50
SF0502-251Y	0.8	250	5000	14 ± 40%	50
SF0502-501Y	1.5	500	4000	19 ± 40%	50
SF0502-102Y	2.7	1000	2000	24 ± 40%	50
SF0502-142Y	3.5	1400	1500	40 ± 40%	50

## PHYSICAL CHARACTERISTICS:

## WINDING:

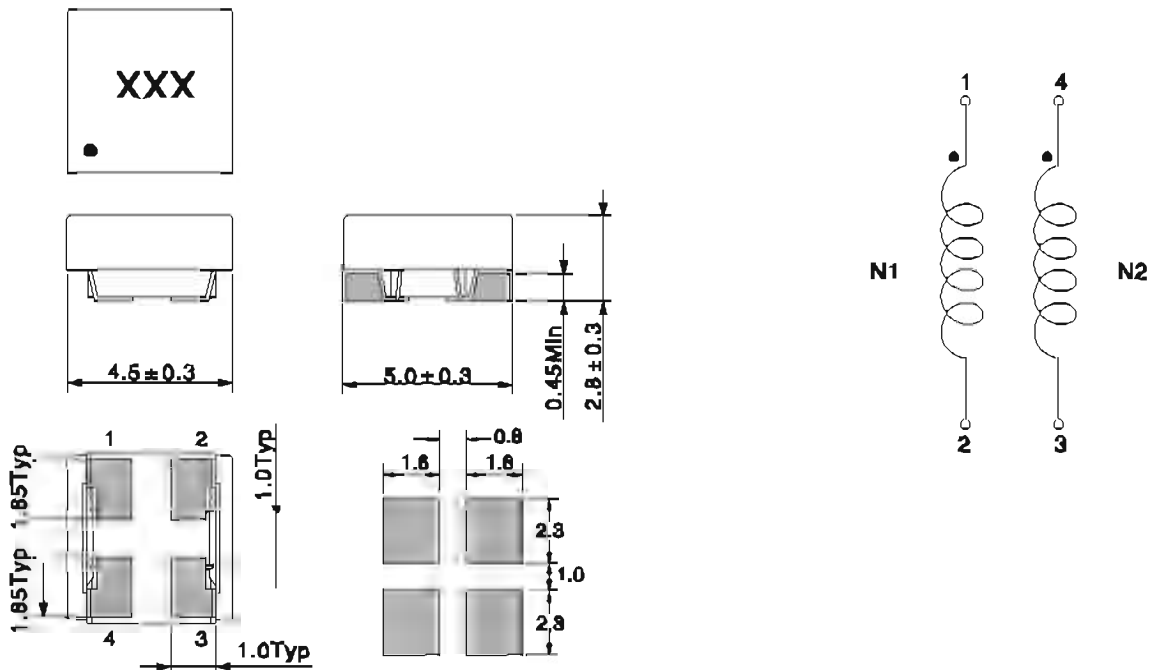

## GENERAL SPECIFICATIONS:

- Dielectric Withstanding Voltage: 125 Vdc
- Insulation resistance: 10M Ω Min
- Temperature Rise: 20 °C at rated current
- Operating Temperature: -40 °C to +125 °C (Temperature rise included)
- Storage Temperature: -40 °C to +125 °C
- Solderability: 250 °C for 5 sec.

Note: All specifications subject to change without notice.

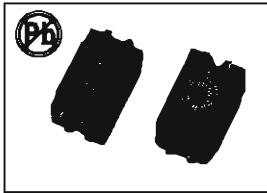

# EMI LINE FILTER SF0503 SERIES

## FEATURES:

- Rated Current 100mA
- Inductance range: 11 to 100uH
- RoHS compliant

## OPTIONS:

- Packaging: Tape & Reel is standard
- Bulk packaging available for smaller quantities

## COMMON APPLICATIONS:

- DC-DC Conversion
- Isolation /Coupling
- Input filter
- Against CMC noise at composite
- EMI suppression

## ELECTRICAL CHARACTERISTICS:@25°C

Part Number	L(0A) (uH)+50%/-30% 10KHz,0.1V	Frequency Range(MHz)	Impedance Z(Ω)Min	DCR(mΩ)Max each winding	Rated current (mA)
SF0503-110Y	11	100-400	450	180	100
SF0503-220Y	22	40-250	900	230	100
SF0503-330Y	33	30-180	1000	270	100
SF0503-500Y	50	20-60	1200	320	100
SF0503-101Y	100	10-50	1400	450	100

## SCHEMATIC

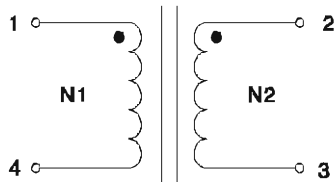

## PHYSICAL CHARACTERISTICS

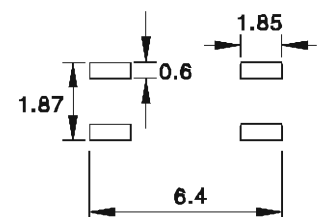
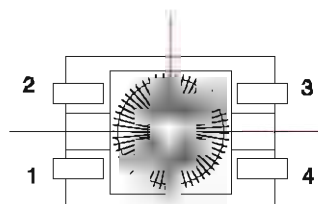
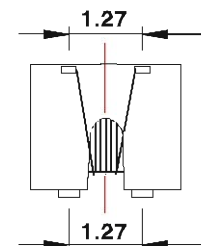
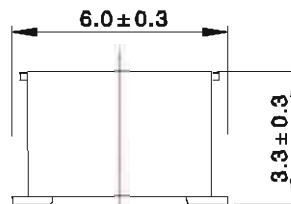
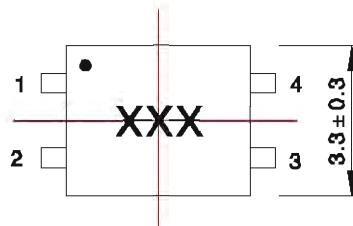

### NOTES:

1. Temperature Rise: 20°C at rated current
2. Rated Voltage: 50 Vdc  
Dielectric Withstanding Voltage: 125 Vdc
3. Operating Temperature:  
-40°C to +125°C(Temperature rise included)
4. Storage Temperature:  
-40 °C to +125°C  
Solderability: 245°C for 5 sec
5. Core Material .....Ferrite
6. Wire .....Enamelled copper
7. Terminal coating .....Sn
8. Packaging.....1000 pcs. per 13-inch reel

Note:All specifications subject to change without notice.



# LINE FILTER SF0504 SERIES

## FEATURES:

- Current rating up to 5A
- Inductance range: 0.6 to 6uH
- Frequency range to 1200 MHz
- RoHS compliant

## OPTIONS:

- Packaging: Tape & Reel is standard
- Bulk packaging available for smaller quantities

## COMMON APPLICATIONS:

- DC-DC Conversion
- Isolation /Coupling
- Input filter
- Against CMC noise in computers
- EMI suppression

## ELECTRICAL CHARACTERISTICS:@25°C

Part Number	L(ΔA) μ H Ref. 100KHz,0.1V	Impedance Z(Ω) @100MHz	DCR(mΩ)Max each winding	Rated current (mA)
SF0504-191Y	0.6	190 ± 35%	20	5000
SF0504-351Y	1.1	350 ± 35%	40	2000
SF0504-102Y	2.7	1000 ± 35%	60	1500
SF0504-152Y	3.6	1500 ± 35%	100	1000
SF0504-302Y	6.0	3000 ± 35%	200	500
SF0504-402Y	2.8	4000 ± 35%	300	200

## SCHEMATIC

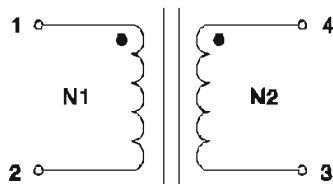

## PHYSICAL CHARACTERISTICS

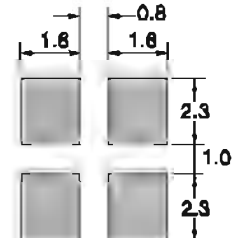
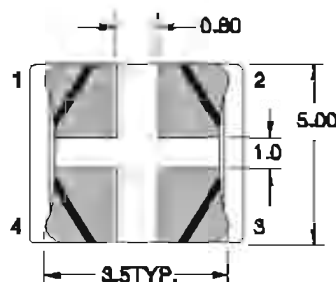
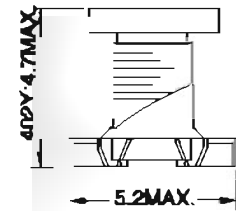
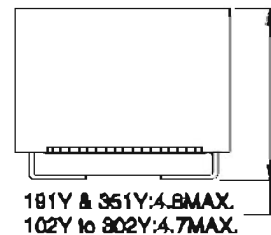
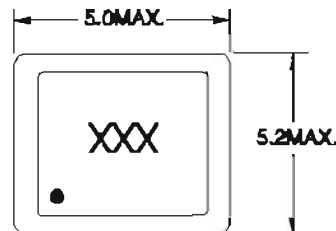

### NOTES:

1. Temperature Rise: 20°C at rated current
2. Rated Voltage: 50 Vdc  
Dielectric Withstanding Voltage: 125 Vdc
3. Operating Temperature:  
-40°C to +125°C(Temperature rise included)
4. Storage Temperature:  
-40 °C to +125°C  
Solderability: 245°C for 5 sec
5. Core Material ..... Ferrite
6. Wire ..... Enamelled copper
7. Terminal coating ..... Sn
8. Packaging ..... 1000 pcs. per 13-Inch reel

Note: All specifications subject to change without notice.



# LINE FILTER SF0602 SERIES

## FEATURES:

- Current rating up to 300mA
- Inductance range: 10 to 330uH
- Frequency range to 1600 MHz
- RoHS compliant

## OPTIONS:

- Packaging: Tape & Reel is standard
- Bulk packaging available for smaller quantities

## COMMON APPLICATIONS:

- DC-DC Conversion
- Isolation /Coupling
- Input filter
- Against CMC noise at composites
- EMI suppression

## ELECTRICAL CHARACTERISTICS:@25°C

Part Number	L (μH) 10KHz,2mV	Lk (μH) Max 10KHz,2mV	DCR(mΩ)Max each winding	Rated current (mA)	Impedance(Z)	
					Frequency Range (MHz)	Min value (Ω)
SF0602-100Y	10 ± 50%	1	240	300	35-570	600
SF0602-470Y	47 ± 50%	4	160	300	4-1600	140
SF0602-820Y	82 ± 50%	4	200	300	3-850	220
SF0602-101Y	100 ± 50%	8	220	300	3-660	280
SF0602-181Y	180 ± 50%	8	250	300	3-250	500
SF0602-221Y	220 ± 50%	10	280	300	3-210	600
SF0602-331Y	330 ± 50%	10	300	300	3-120	900

## SCHEMATIC

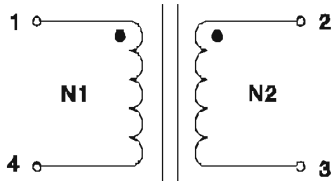

### NOTES:

1. Temperature Rise: 20°C at rated current
2. Rated Voltage: 50 Vdc  
Dielectric Withstanding Voltage: 125 Vdc
3. Operating Temperature:  
-40°C to +105°C(Temperature rise included)
4. Storage Temperature:  
-40°C to +105°C  
Solderability: 280°C for 5 sec
5. Core Material ..... Ferrite
6. Wire ..... Enamelled copper
7. Terminal coating ..... Sn
8. Base ..... LCP
9. Packaging..... 1000 pcs. per 7-inch reel

## PHYSICAL CHARACTERISTICS

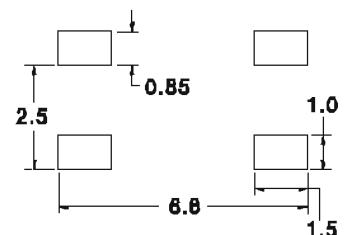
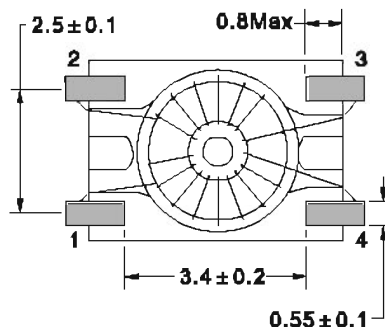
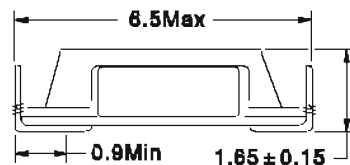
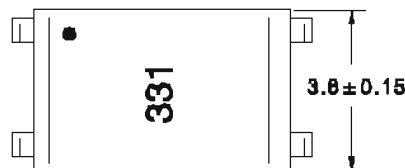

Note: All specifications subject to change without notice.

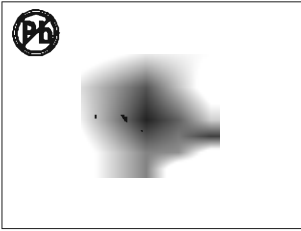

# SMD LINE FILTER

## SF0903 SERIES

### FEATURES:

- Low profile very effective in space conscious applications
- Low resistance filters have been designed for excellent electrical isolation
- High quality toroidal core
- Wide frequency range over 1000MHz
- Lead free construction

### OPTIONS:

- Tape & Reel is Standard
- Bulk packaging Available for Smaller Quantities

### COMMON APPLICATIONS:

- Provide common mode noise attenuation
- Reduce conducted noise
- For the suppression of EMI in data lines and signal lines, e.g., CAN Bus

### ELECTRICAL CHARACTERISTICS:

Part Number	L(μH) 100K/0.1V	L-L(μH) 100K/0.02V	C(pF) 100K/0.02V	DCR(Ω) max.	Turns Ratio	Insertion Loss		Impedance(z)	
						Freq.rang	db	Freq.rang	min(Ω)
470YAB	47.0 min.	0.18 <sup>+0</sup>	20 <sup>+0</sup>	0.4	1:1	1~100MHz	20 <sup>-0</sup>	10~30MHz	1000
200YAB	20.0 min.	0.10 <sup>+0</sup>	18 <sup>+0</sup>	0.4	1:1:1	30~300MHz	20 <sup>-0</sup>	30~100MHz	800

### TECHNICAL INFORMATION & PHYSICAL CHARACTERISTICS:

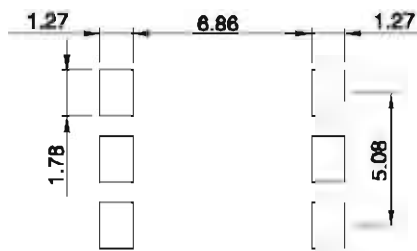
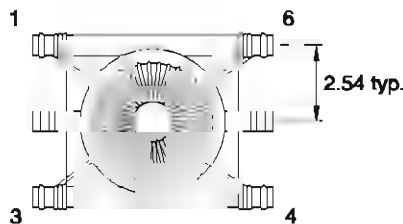
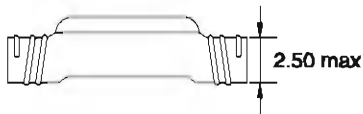
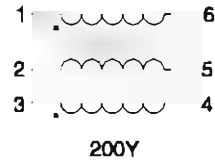
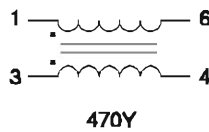
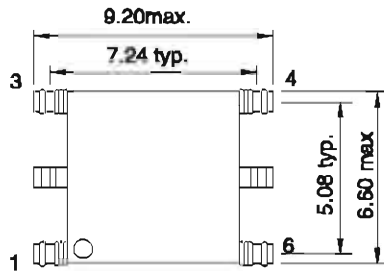

PCB layout

#### General Specification:

1. Storage Temperature: -40°C - +105°C
2. Operation Temperature: -25°C - +85°C
3. Temperature Rise Included: 30°C max at Rated Current
4. Resistance to solder heat: 260°C, 10 secs.

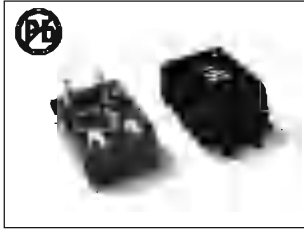

## SMD LINE FILTER SF0904 SERIES

### FEATURES:

- Low profile very effective in space conscious applications
- Low resistance filters have been designed for excellent electrical isolation
- High quality toroidal core
- Lead free construction
- RoHS-compatible

### OPTIONS:

- Tape & Reel is Standard
- Bulk packaging Available for Smaller Quantities

### COMMON APPLICATIONS:

- Provide common mode noise attenuation
- Reduce conducted noise
- For the suppression of EMI in data lines and signal lines, e.g., CAN Bus

### ELECTRICAL CHARACTERISTICS:

Part Number	L(1-4)( $\mu$ H) $\leq 1\text{mH} @ 100\text{KHz}$ $> 1\text{mH} @ 10\text{KHz}$ +50%/-30%	LK(1-4)(nH) $\leq 11\mu\text{H} @ 1\text{MHz}$ $> 11\mu\text{H} @ 100\text{KHz}$ (2-3 short)max.	DCR (winding) (m $\Omega$ ) max.	Rated Current (mA) max.	HI-Pot Vdc,2S
SF0904-110Y	11.0	50	80	500	250
SF0904-250Y	25.0	60	110	500	250
SF0904-510Y	51.0	70	140	500	250
SF0904-471Y	470	100	170	500	250
SF0904-102Y	1000	100	170	500	250
SF0904-222Y	2200	200	400	400	250
SF0904-472Y	4700	300	510	200	250

### TECHNICAL INFORMATION & PHYSICAL CHARACTERISTICS:

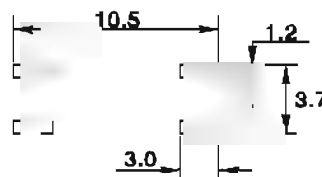
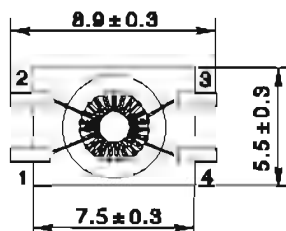
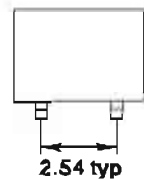
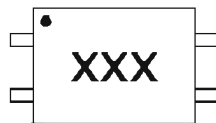

Suggest PCB Layout

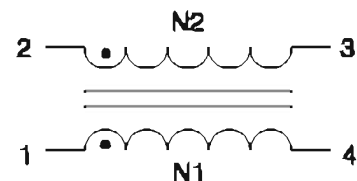

#### Materials:

1. Core: Ferrite Toroidal Core
2. Wire: Enamelled Copper Wire(Class F)
3. Case: PPHS (ULB40V-0)
4. Terminal: Cu / Ni / Sn
5. Adhesive: Epoxy Resin

#### General Specification:

1. Storage Temperature: -40°C -- +125°C
2. Operation Temperature: -40°C -- +85°C
3. Temperature Rise Included: 40°C max at Rated Current
4. Resistance to solder heat: 280°C, 10 sec.

#### Note:

All specifications subject to change without notice.

# COMMON MODE CHOKE

## SF0904A SERIES



### FEATURES:

- The circular type, small size and low profile
- Suppression of common mode noise at high frequency
- Excellent mechanical
- AEC-Q200 verified
- Operating temperature: -50°C to +150°C

### APPLICATIONS:

- Data and signal line

### OPTIONS:

- Tape & Reel is Standard

### ELECTRICAL CHARACTERISTICS:

Part Number	Inductance (uH)	LK(nH) Typ.	DCR (Ω) max.	Rated Current (mA) max.	Vtest (Vdc/2S)	Operating temperature range(°C)
SF0904A-5R0N	5 ± 30%	40@1MHz	0.06	1200	250	-50 - +150
SF0904A-110N	11 ± 30%	50@1MHz	0.08	800	250	-50 - +150
SF0904A-250N	25 ± 30%	60@100KHz	0.11	800	250	-50 - +150
SF0904A-250NS	25 ± 30%	1400@100KHz	0.11	800	250	-50 - +150
SF0904A-510N	51 ± 30%	70@100KHz	0.14	800	250	-50 - +150
SF0904A-510NS	51 ± 30%	2300@100KHz	0.14	800	250	-50 - +150
SF0904A-101N	100 ± 30%	100@100KHz	0.18	500	250	-50 - +150
SF0904A-471N	470 ± 30%	100@100KHz	0.17	700	750	-40 - +125
SF0904A-102Y	1000 +50%/-30%	70@100KHz	0.14	700	750	-40 - +125
SF0904A-222Y	2200 +50%/-30%	120@100KHz	0.4	500	750	-40 - +125
SF0904A-472Y	4700 +50%/-30%	250@100KHz	0.55	400	750	-40 - +125

1. Inductance test frequency:  $\leq 1000\mu\text{H}$ , 100KHz, 0.1V  
 $> 1000\mu\text{H}$ , 10KHz, 0.1V
2. Storage Temperature Range (packaging conditions): -10°C~+40°C and RH 70% (Max.)
3. Rated Voltage: 42VAC (50/60Hz) / 80VDC
4. Products with other electrical characteristics can be provided upon customer's request.

### TECHNICAL INFORMATION & PHYSICAL CHARACTERISTICS:

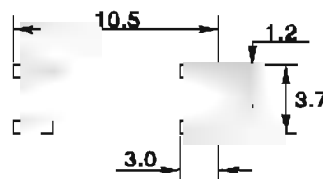
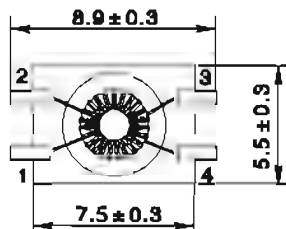
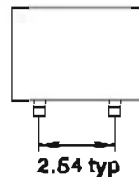
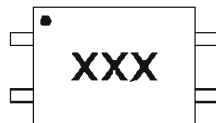

Suggest PCB Layout

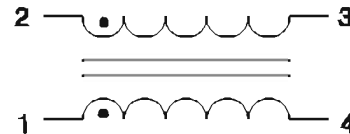

### Note:

All specifications subject to change without notice.

## TYPICAL ELECTRICAL CHARACTERISTICS

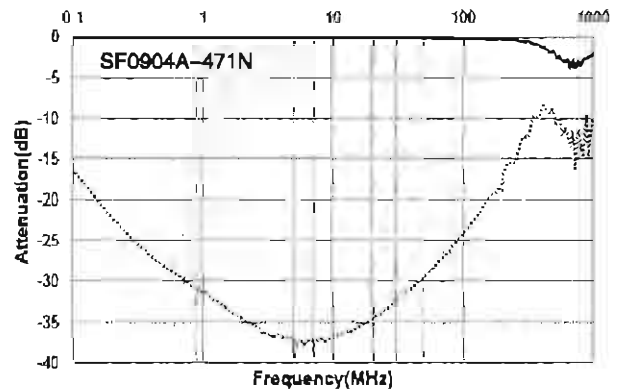
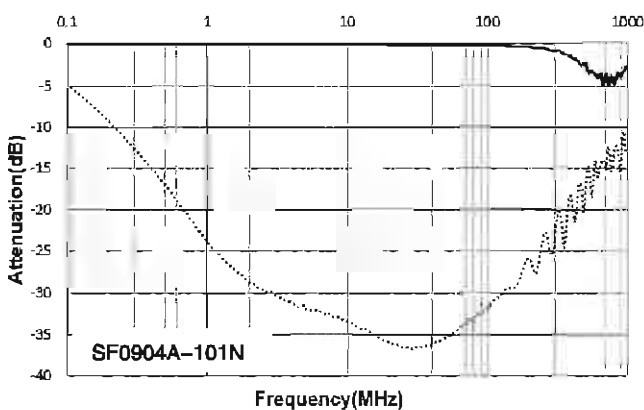
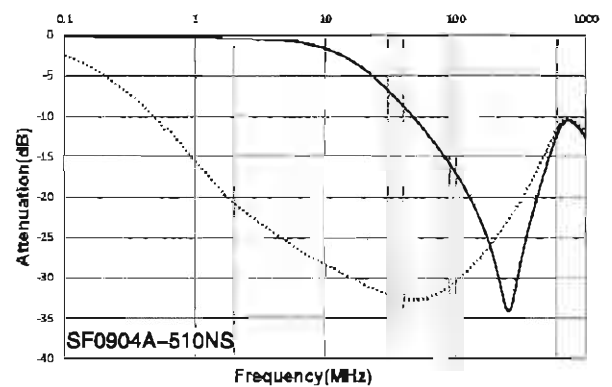
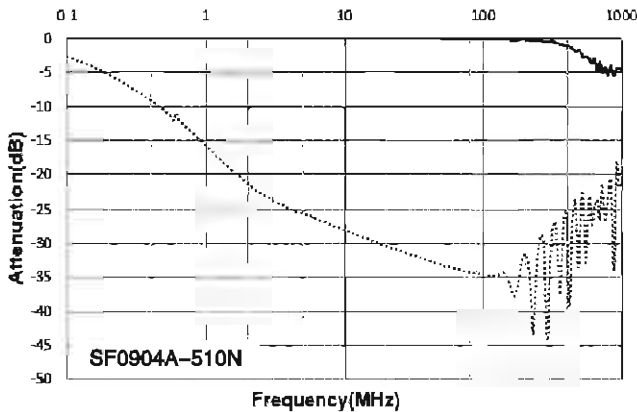
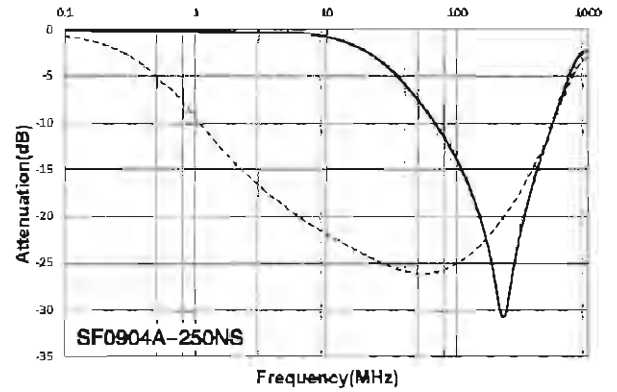
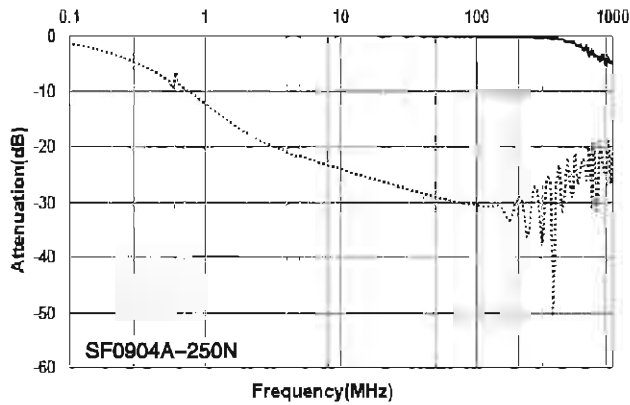
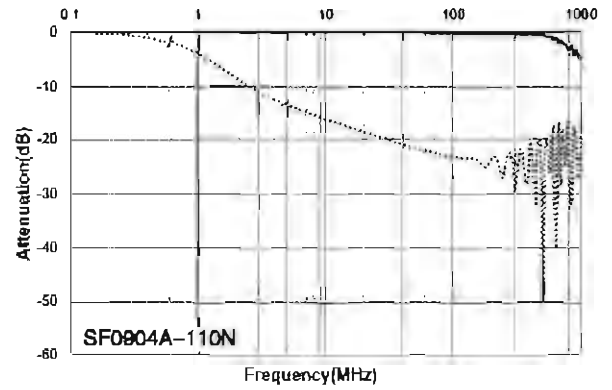
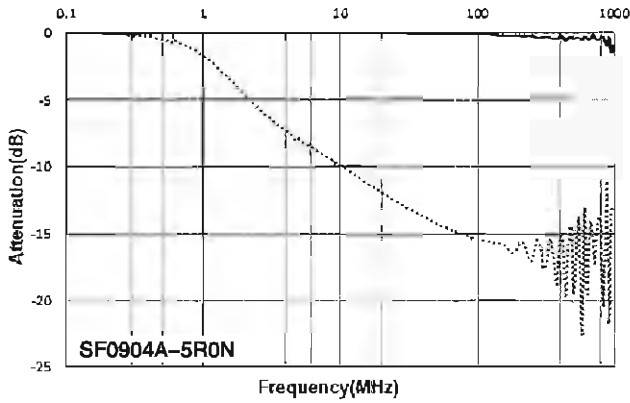

## TYPICAL ELECTRICAL CHARACTERISTICS

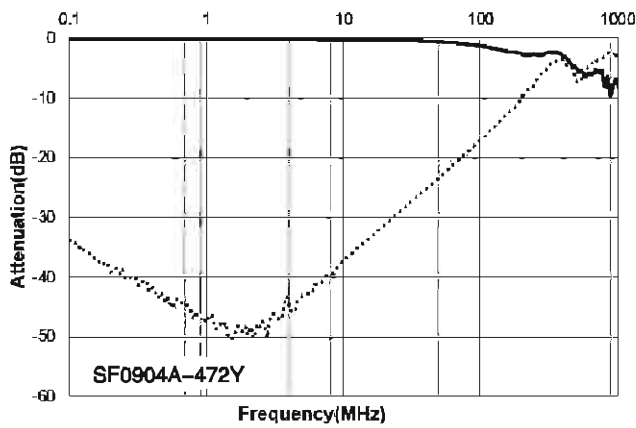
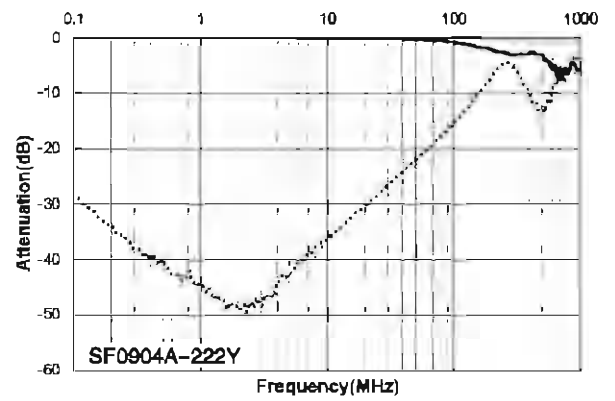
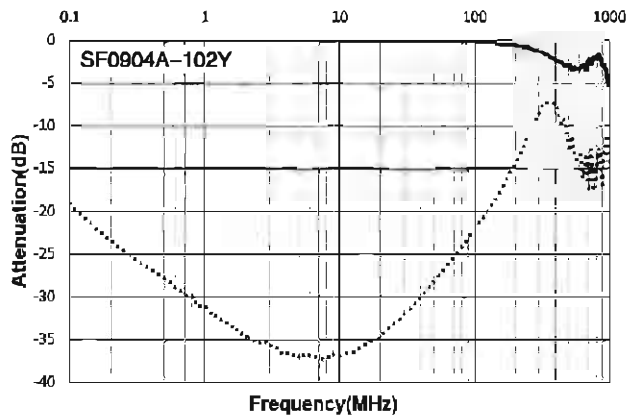

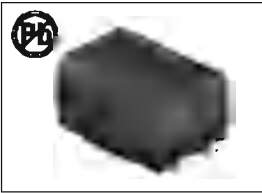

# LINE FILTER

## SF0905 SERIES

### FEATURES:

- Current rating up to 1.8A
- Inductance range: 10 to 8500uH
- Frequency range to 300 MHz
- RoHS compliant

### OPTIONS:

- Packaging: Tape & Reel is standard
- Bulk packaging available for smaller quantities

### COMMON APPLICATIONS:

- DC-DC Conversion
- Isolation /Coupling
- Input filter
- Against CMC noise at composites
- EMI suppression

### ELECTRICAL CHARACTERISTICS:@25°C

Part Number	L (μH)	Lk (nH) typ @1MHz	DCR(mΩ)Max each winding	Rated current (A)	Impedance(Z)	
					Frequency Range (MHz)	Min value (Ω)
SF0905-100Y	10 ± 50%	850	80	1.6	20-300	200
SF0905-250Y	25 ± 50%	1942	160	1.0	20-150	600
SF0905-400Y	40 ± 50%	2812	250	0.9	20-100	800
SF0905-500Y	50 ± 50%	3150	320	0.8	20-100	1500
SF0905-251Y	250 ± 50%	110	130	1.2	3-20	800
SF0905-471Y	470 ± 50%	120	140	1.1	2-20	1000
SF0905-501Y	500 ± 50%	120	150	1.0	1-20	1000
SF0905-102Y	1000 ± 50%	170	310	0.8	1-15	1500
SF0905-202Y	2000 ± 50%	250	420	0.8	1-5	3000
SF0905-472Y	4700 ± 50%	360	900	0.4	0.3-3	4000
SF0905-852Y	8500 ± 50%	390	1050	0.3	0.3-2	5000

Test condition: 10-50uH: 1KHz,0.1V; 250-8500uH: 100KHz,5mV

### SCHEMATIC

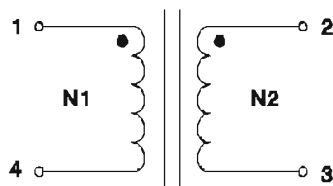

#### NOTES:

1. Temperature Rise: 20°C at rated current
2. Rated Voltage: 50 Vdc  
Dielectric Withstanding Voltage: 125 Vdc
3. Operating Temperature:  
-40°C to +105°C(Temperature rise included)
4. Storage Temperature:  
-40 °C to +105°C  
Solderability: 260°C for 5 sec
5. Core Material .....Ferrite
6. Wire .....Enameled copper
7. Terminal coating .....Sn
8. Base .....LGP
9. Packaging.....1000 pcs. per 13-Inch reel

### PHYSICAL CHARACTERISTICS

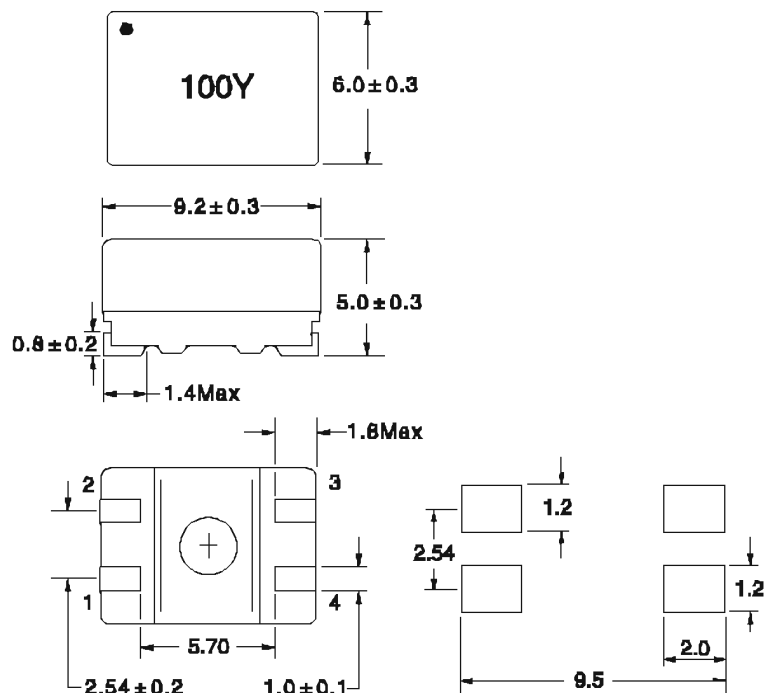

Note:All specifications subject to change without notice.

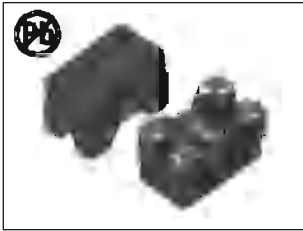

# SMD WIRE WOUND COMMON MODE FILTER

## SF1210 SERIES

### FEATURES:

- High common mode impedance at high frequency effects excellent noise suppression performance.

### APPLICATIONS:

- Common mode noise suppression of signal lines in high speed and high density digital equipment such as personal computers and peripherals.

### ELECTRICAL CHARACTERISTICS:

Part Number	Impedance ( $\Omega$ ) $\pm 25\%$	Test frequency (MHz)	DCR ( $\Omega$ ) Max	Rated Current (mA) Max	Rated Voltage (V)	Insulation resistance (Min)
SF1210-250	25	100	0.3	300	20	10M $\Omega$
SF1210-600	60	100	0.4	300	20	10M $\Omega$
SF1210-670	67	100	0.4	300	20	10M $\Omega$
SF1210-800	80	100	0.5	280	20	10M $\Omega$
SF1210-121	120	100	0.55	270	20	10M $\Omega$
SF1210-181	160	100	0.58	260	20	10M $\Omega$
SF1210-181	180	100	0.6	260	20	10M $\Omega$
SF1210-251	250	100	0.7	230	20	10M $\Omega$
SF1210-331	330	100	0.8	200	20	10M $\Omega$

### TECHNICAL INFORMATION & PHYSICAL CHARACTERISTICS:

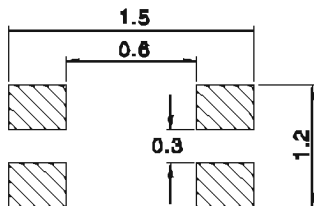
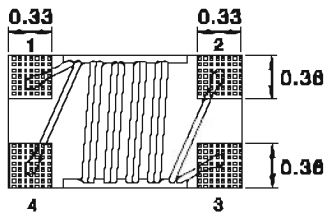
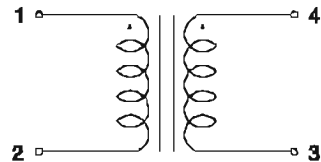
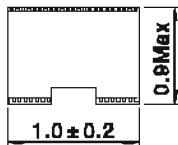
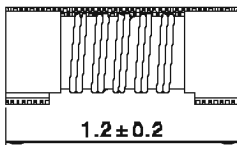

- Inductance Testing: 100MHz E4991A
- RDC: QuadTech 1880 Milliohm meter
- Operating temperature: -40°C to +85°C
- Storage Temperature: 40°C Max, 70% RH Max
- Resistance to soldering heat: 280°C for 10 seconds
- Marking: Part number

Note: All specifications subject to change without notice.



# SMD WIRE WOUND COMMON MODE FILTER

## SF1210 SERIES

### IMPEDANCE FREQUENCY:

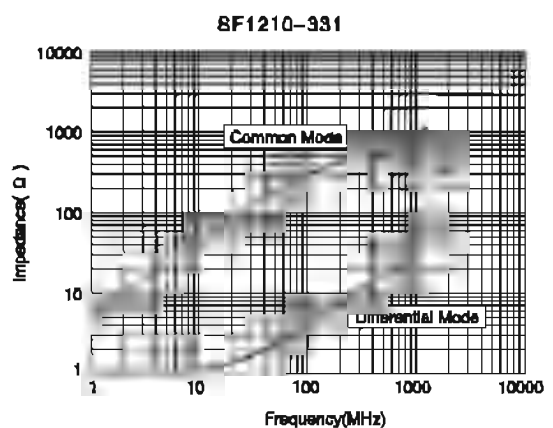
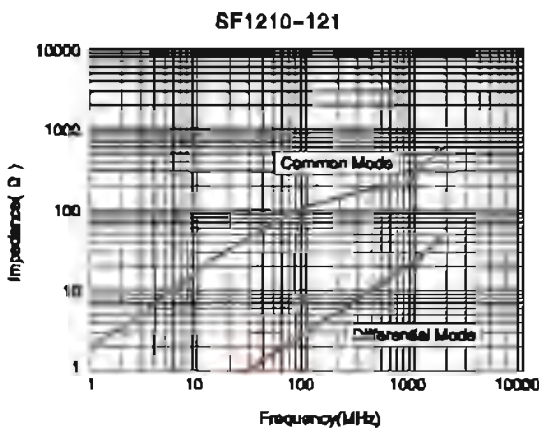
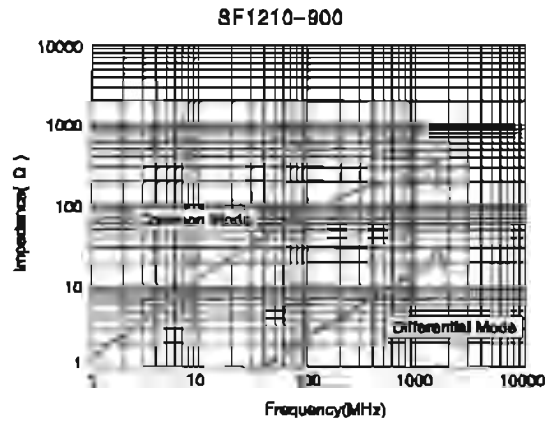
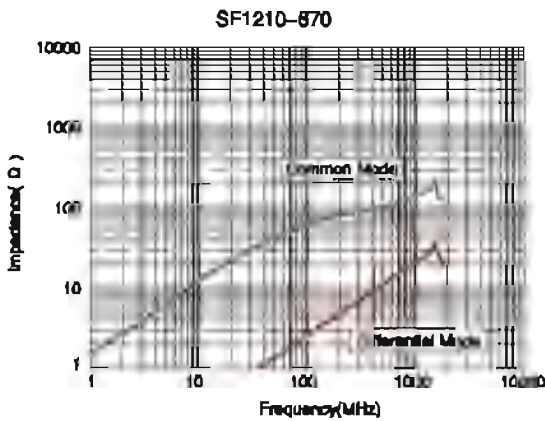
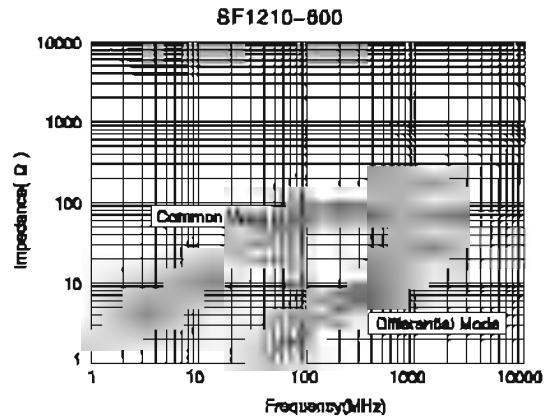
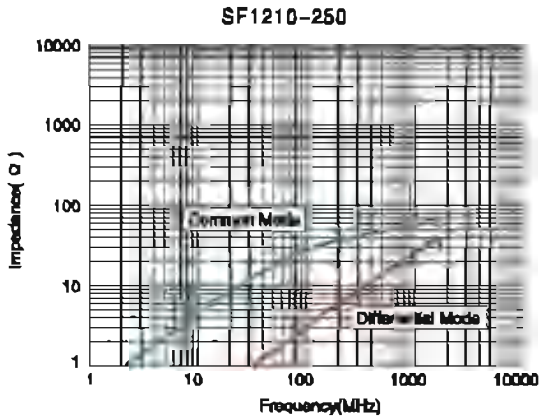

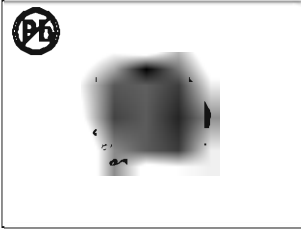

## SMD LINE FILTER SF1306 SERIES

### FEATURES:

- Low profile very effective in space conscious applications
- Low resistance filters have been designed for excellent electrical isolation
- High quality toroidal core
- Wide frequency range over 1000MHz
- Lead free construction

### OPTIONS:

- Tape & Reel is Standard
- Bulk packaging Available for Smaller Quantities

### COMMON APPLICATIONS:

- Provide common mode noise attenuation
- Reduce conducted noise
- For the suppression of EMI in data lines and signal lines, e.g., CAN Bus

### ELECTRICAL CHARACTERISTICS:

Part Number	Inductance ( $\mu H$ )		DC resistance N1,N2( $\Omega$ )	Rated Current (A)	Impedance ( $\Omega$ )	Freq. rang (MHz)	Flg
	L1,L2	L1-L2					
350YA	35 $\pm$ 35%	4 max.	0.035 max	2.70max	400 min	5.0-250	B
600YA	60 $\pm$ 35%	5 max.	0.065max	2.00max	600min	5.0-100	B
101YA	100 $\pm$ 35%	15 max.	0.100max	0.70max	300min	1.0-50	A
251YA	250 $\pm$ 35%	25 max.	0.150max	0.60max	600min	1.0-40	A
501YA	500 $\pm$ 35%	35 max.	0.300max	0.40max	1200min	1.0-40	A
102YA	1000 $\pm$ 35%	45 max.	0.400max	0.35max	2200min	0.5-10	A
501YA	500 $\pm$ 35%	35 max.	0.300max	0.40max	1200min	1.0-40	A
102YA	1000 $\pm$ 35%	45 max.	0.400max	0.35max	2200min	0.5-10	A

### TECHNICAL INFORMATION & PHYSICAL CHARACTERISTICS:

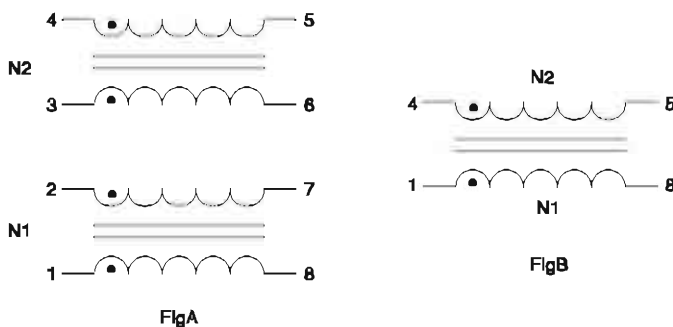
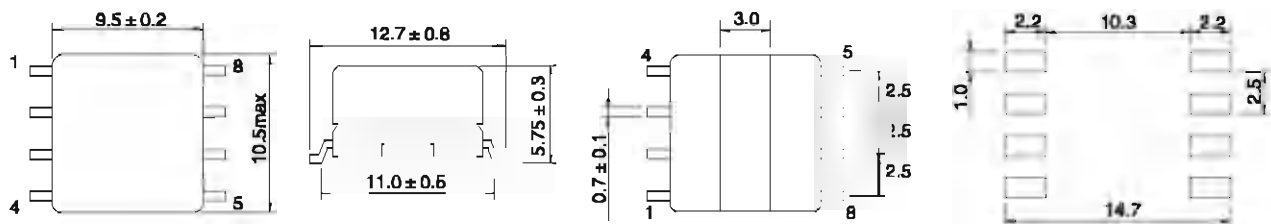

#### Materials:

1. Core: Ferrite Toroidal Core
2. Wire: Enamelled Copper Wire
3. Base: LCP
4. Terminal: Tinned Copper Plate
5. Adhesive: Epoxy Resin
6. Case: LCP

#### General Specification:

1. Storage Temperature:  $-25^{\circ}C - +85^{\circ}C$
2. Operating Temperature:  $-20^{\circ}C - +80^{\circ}C$
3. Resistance to solder heat:  $260^{\circ}C, 10$  secs.

Note: All specifications subject to change without notice.



# SURFACE-MOUNT WOUND COMMON MODE CHOKES SF1812F SERIES

## FEATURES:

- Ferrite Core bobbin construction
- High frequency and Large current
- Excellent Mechanical Strength
- Excellent Solderability
- Excellent Frequency performance
- Low Profile and Low cost

## COMMON APPLICATIONS:

- Differential signal line common mode noise suppression.
- Multimedia devices
- Automotive applications such as ADAS, Infotainment, Sensing, TCU
- Automotive Ethernet

## ELECTRICAL CHARACTERISTICS:@25°C

Part Number	Inductance (uH)+50%/-30% 100KHz	Impedance Z (Ω) ± 25% 100MHz	Rated current (mA)	DCR (Ω)	Rated voltage (Vdc)
SF1812F-600Y	-	60	4100	0.1	60
SF1812F-900Y	0.3	90	3800	0.2	60
SF1812F-121Y	-	120	3600	0.22	60
SF1812F-231Y	-	230	3500	0.22	60
SF1812F-251Y	-	250	3500	0.22	60
SF1812F-421Y	-	420	2850	0.22	60
SF1812F-601Y	1.0	600	2600	0.30	60
SF1812F-701Y	-	700	2500	0.15	60
SF1812F-801Y	1.3	800	2300	0.16	60
SF1812F-102Y	-	1000	1750	0.40	60
SF1812F-122Y	-	1200	1700	0.40	60
SF1812F-142Y	-	1400	1700	0.40	60
SF1812F-282Y	4.2	2800	800	0.60	60
SF1812F-502Y	11	5000	580	0.80	60
SF1812F-582Y	-	5800	350	2.00	60
SF1812F-802Y	22	8000	320	2.85	60

## PHYSICAL CHARACTERISTICS:

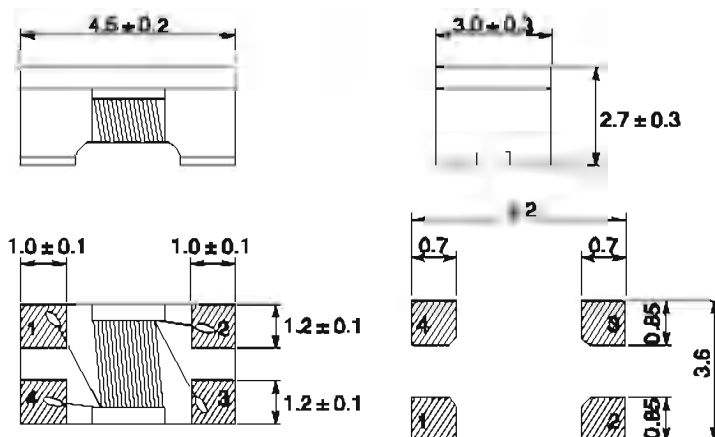

## WINDING:

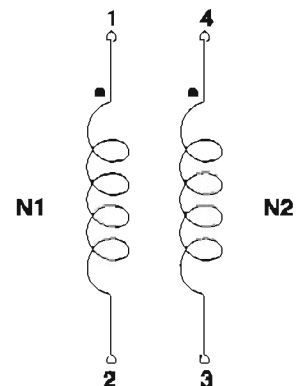

## GENERAL SPECIFICATIONS:

- Temperature Rise: 40 °C at rated current
- Operating Temperature: -40 °C to +125 °C (Temperature rise included)
- Storage Temperature: -40 °C to +125 °C
- Packaging: Tape & Reel is standard (Qty: 500PCS)
- Notes: All specifications subject to change without notice.

# SURFACE-MOUNT WOUND COMMON MODE CHOKES SF1812F SERIES



## FEATURES:

- Ferrite Core bobbin construction
- High frequency and Large current
- Excellent Mechanical Strength
- Excellent Solderability
- Excellent Frequency performance
- Low Profile and Low cost

## COMMON APPLICATIONS:

- Differential signal line common mode noise suppression.
- Multimedia devices
- Automotive applications such as ADAS, Infotainment, Sensing, TCU
- Automotive Ethernet

## FREQUENCY VS IMPEDANCE

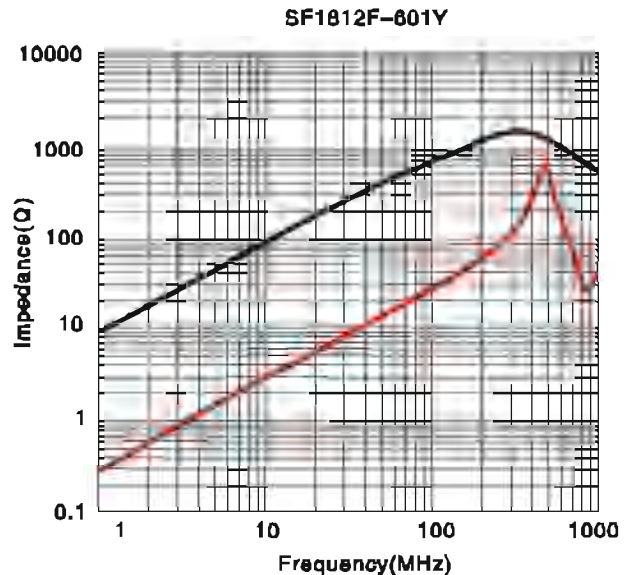
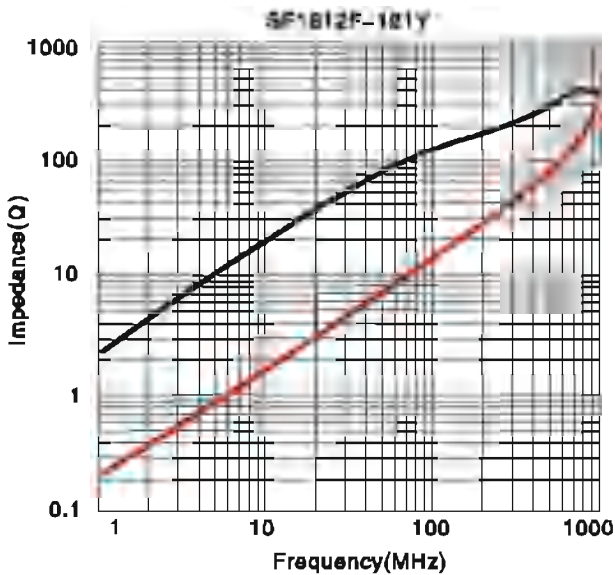
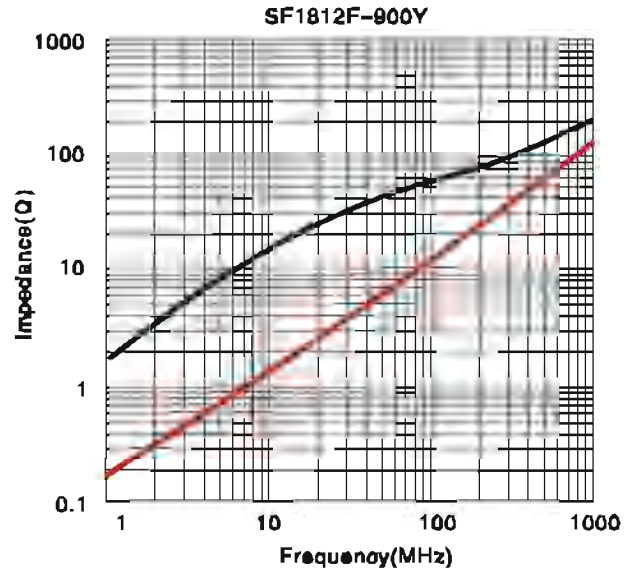
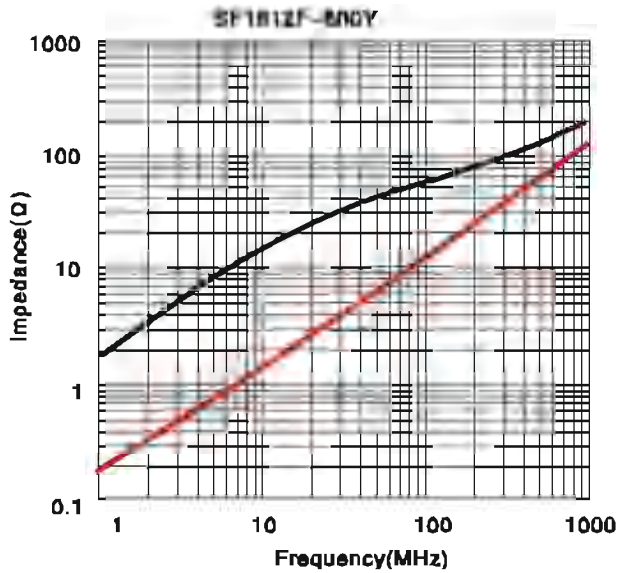

— Com — DIF

# SURFACE-MOUNT WOUND COMMON MODE CHOKES SF1812F SERIES



## FEATURES:

- Ferrite Core bobbin construction
- High frequency and Large current
- Excellent Mechanical Strength
- Excellent Solderability
- Excellent Frequency performance
- Low Profile and Low cost

## COMMON APPLICATIONS:

- Differential signal line common mode noise suppression.
- Multimedia devices
- Automotive applications such as ADAS, Infotainment, Sensing, TCU
- Automotive Ethernet

## FREQUENCY VS IMPEDANCE

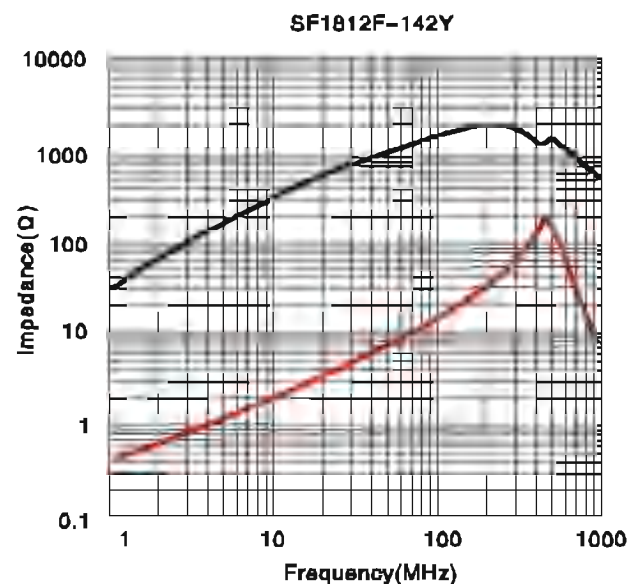
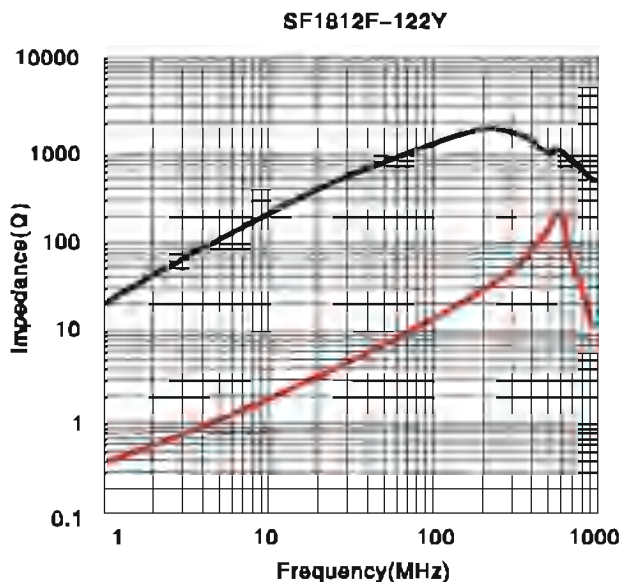
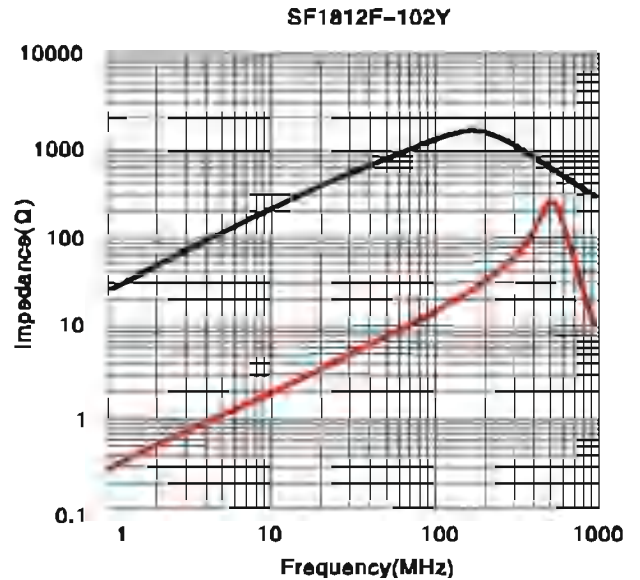
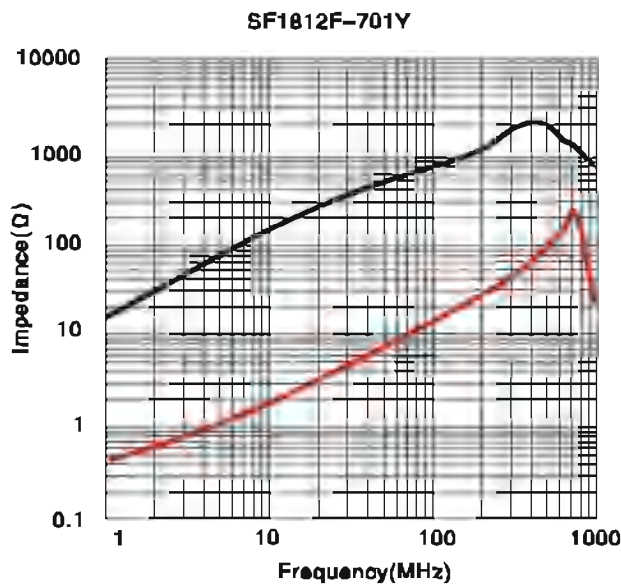

— Com — DIF

# SURFACE-MOUNT WOUND COMMON MODE CHOKES SF1812F SERIES



## FEATURES:

- Ferrite Core bobbin construction
- High frequency and Large current
- Excellent Mechanical Strength
- Excellent Solderability
- Excellent Frequency performance
- Low Profile and Low cost

## COMMON APPLICATIONS:

- Differential signal line common mode noise suppression.
- Multimedia devices
- Automotive applications such as ADAS, Infotainment, Sensing, TCU
- Automotive Ethernet

## FREQUENCY VS IMPEDANCE

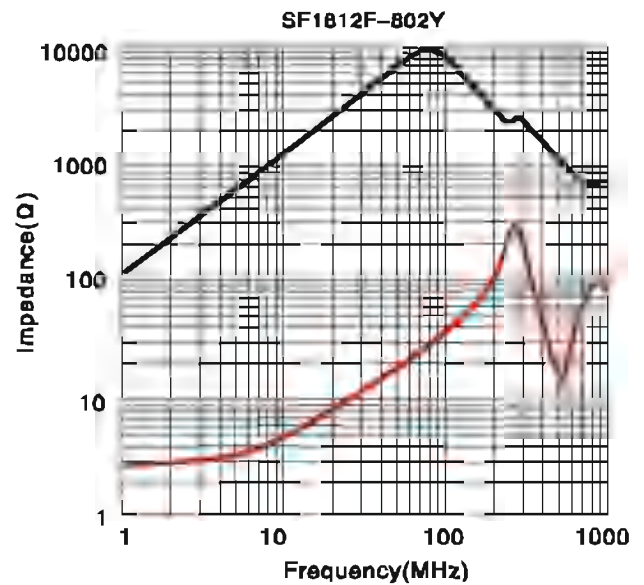
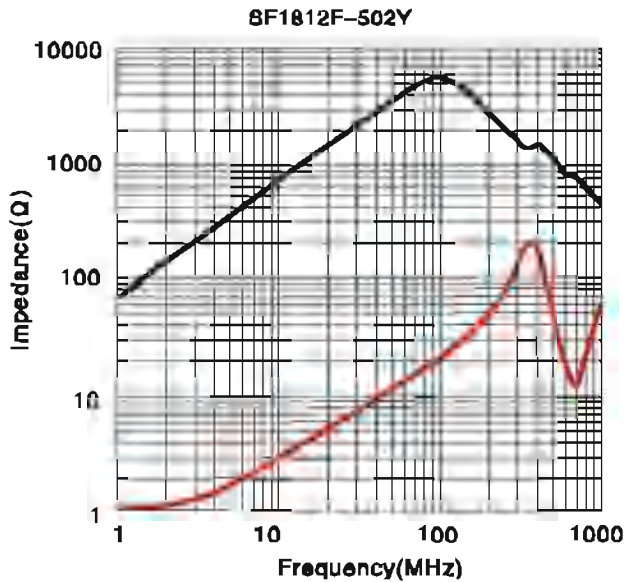

— Com — Diff

# COUPLED INDUCTORS, COMMON MODE CHOKES SF1812S SERIES

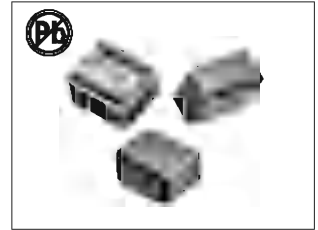

## FEATURES:

- Coupled inductor optimized for xDSL filtering applications
- Can be used as a common mode choke, 1:1 transformer or in SEPIC applications
- Terminations RoHS compliant
- Packaging 600/7" reel; 2200/13" reel

## ELECTRICAL CHARACTERISTICS:

Part number	Inductance ± 20%(uH) 100KHz,0.1V	Q 1MHz	DCR Max(Ω)	SRF Min(MHz)	Isat (mA)	Irms (mA)
SF1812S-1R0M	1.0	38	0.2	285	2400	2100
SF1812S-2R2M	2.2	29	0.33	175	1500	1200
SF1812S-4R7M	4.7	43	0.41	102	1500	1000
SF1812S-100M	10	35	0.74	74	800	780
SF1812S-150M	15	37	0.96	65	700	710
SF1812S-220M	22	38	1.84	54	500	530
SF1812S-390M	39	39	2.6	5.7	450	420
SF1812S-470M	47	40	2.66	4.8	400	390

1. DC current at which the inductance drops 10% (typ) from its value without current.
2. Current that causes a 40 °C temperature rise from 25 °C ambient. This information is for reference only and does not represent absolute maximum ratings.
3. Electrical specifications at 25 °C .
4. Ambient temperature -40 °C to +85 °C with I rms current
5. Maximum part temperature +125 °C (ambient + temp rise)
6. Storage temperature Component: -40 °C to +125 °C . Tape and reel packaging: -40 °C to +80 °C

## PHYSICAL CHARACTERISTICS & WINDING:

Dimensions are in mm

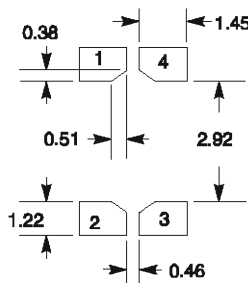
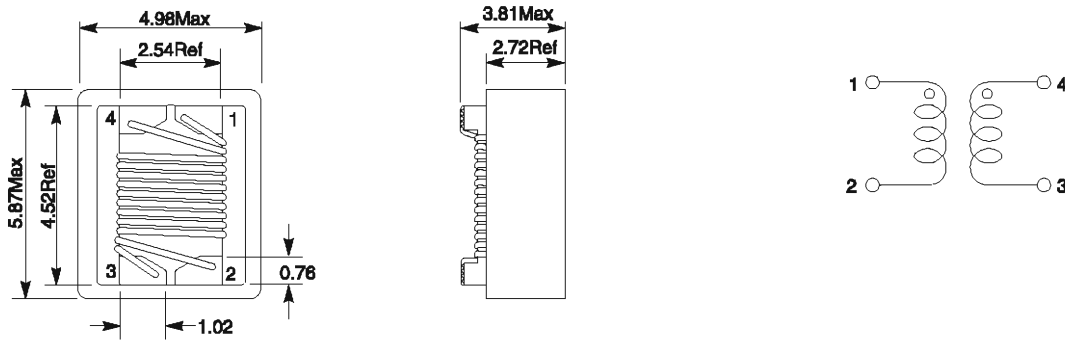

Recommended Land Pattern

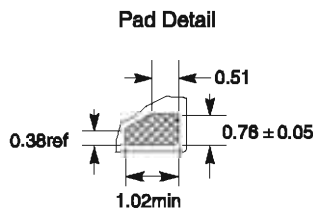

# PERFORMANCE CURVE:

Typical L vs Frequency

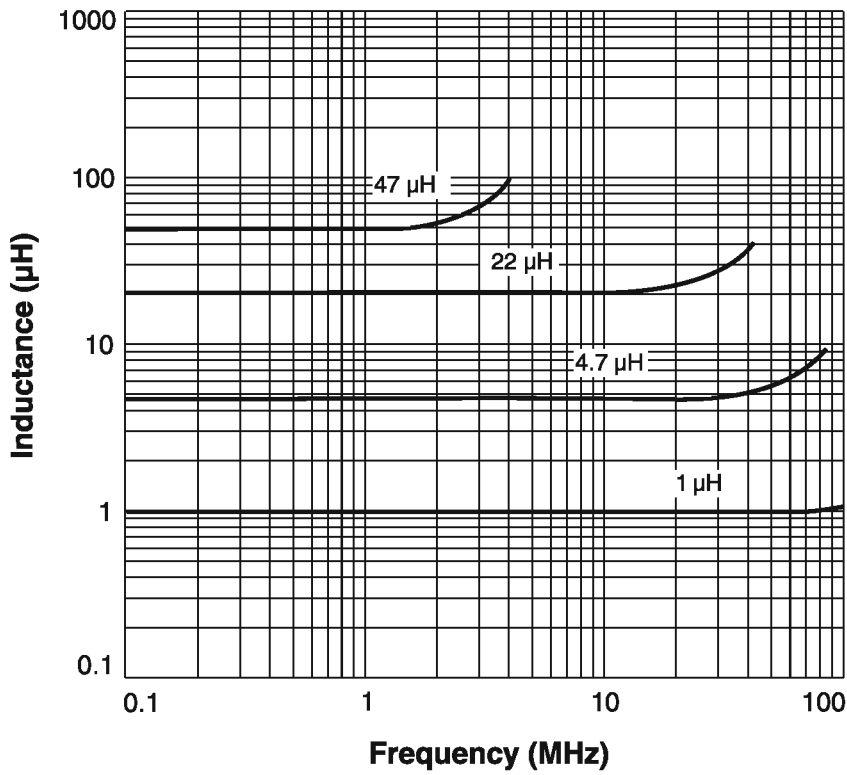

Typical Q vs Frequency

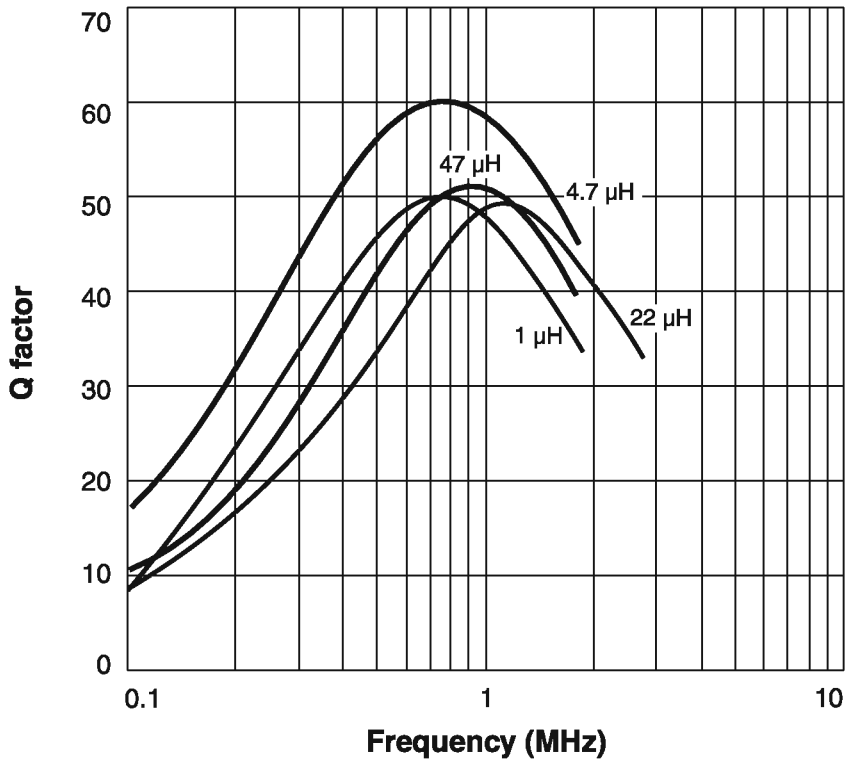

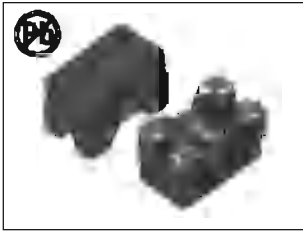

## SMD WIRE WOUND COMMON MODE FILTER SF2012 SERIES

### FEATURES:

- High common mode impedance at high frequency effects excellent noise suppression performance.

### APPLICATIONS:

- Common mode noise suppression of signal lines in high speed and high density digital equipment such as personal computers and peripherals.

### ELECTRICAL CHARACTERISTICS:

Part Number	Impedance (Ω) ± 25%	Test frequency (MHz)	DCR (Ω) Max	Rated Current (mA) Max	Rated Voltage (V)	Insulation resistance (Min)
SF2012-240	24	100	0.25	420	50	10MΩ
SF2012-250	25	100	0.25	420	50	10MΩ
SF2012-320	32	100	0.25	400	50	10MΩ
SF2012-600	60	100	0.30	300	50	10MΩ
SF2012-670	67	100	0.30	400	50	10MΩ
SF2012-900	90	100	0.30	400	50	10MΩ
SF2012-121	120	100	0.30	350	50	10MΩ
SF2012-161	160	100	0.30	350	50	10MΩ
SF2012-181	180	100	0.35	330	50	10MΩ
SF2012-221	220	100	0.35	330	50	10MΩ
SF2012-261	260	100	0.40	300	50	10MΩ
SF2012-361	360	100	0.40	280	50	10MΩ

### TECHNICAL INFORMATION & PHYSICAL CHARACTERISTICS:

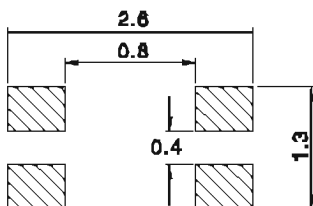
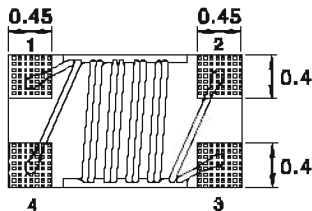
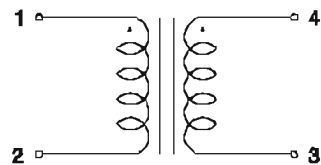
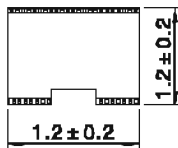
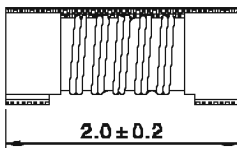

- Impedance Testing: 100MHz E4991A
- RDC: QuadTech 1880 Milliohm meter
- Operating temperature: -40°C to +85°C
- Storage Temperature: 40°C Max, 70%RH Max
- Resistance to soldering heat: 260°C for 10 seconds
- Marking: Part number

Note: All specifications subject to change without notice.

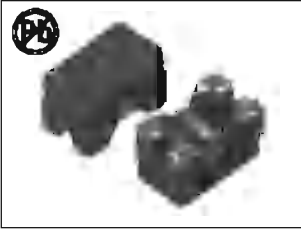

# SMD WIRE WOUND COMMON MODE FILTER SF2012 SERIES

## IMPEDANCE FREQUENCY:

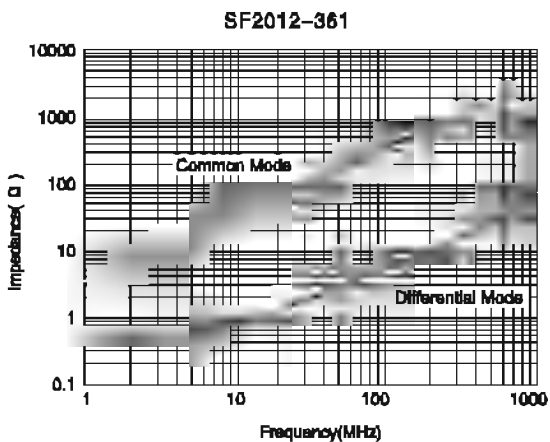
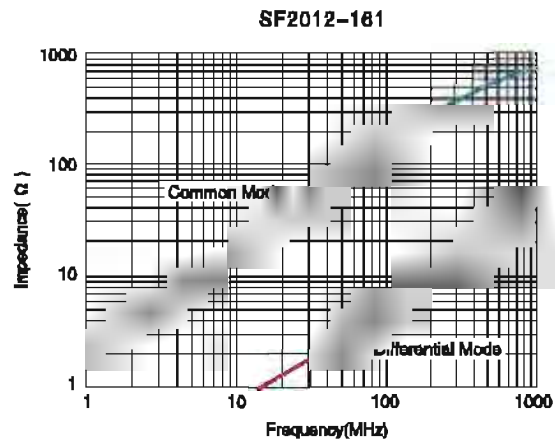
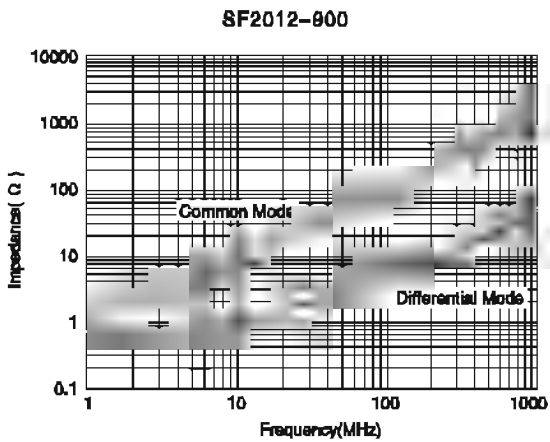
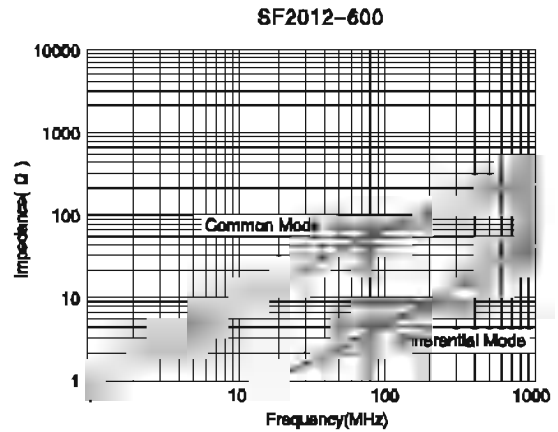
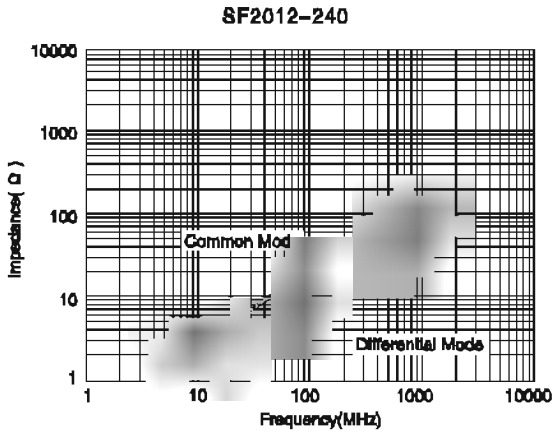

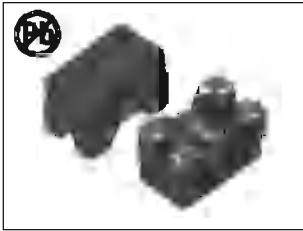

## SMD WIRE WOUND COMMON MODE FILTER

### SF3216 SERIES

#### FEATURES:

- High common mode impedance at high frequency effects excellent noise suppression performance.

#### APPLICATIONS:

- Common mode noise suppression of signal lines in high speed and high density digital equipment such as personal computers and peripherals.

#### ELECTRICAL CHARACTERISTICS:

Part Number	Impedance (Ω) ± 25%	Test frequency (MHz)	DCR (Ω) Max	Rated Current (mA) Max	Rated Voltage (V)	Insulation resistance (Min)
SF3216-370	37	100	0.10	1000	50	10MΩ
SF3216-101	100	100	0.14	850	50	10MΩ
SF3216-171	170	100	0.18	700	50	10MΩ
SF3216-261	260	100	0.22	600	50	10MΩ
SF3216-371	370	100	0.26	600	50	10MΩ
SF3216-531	530	100	0.30	600	50	10MΩ
SF3216-871	870	100	0.34	500	50	10MΩ
SF3216-871	870	100	0.38	500	50	10MΩ
SF3216-112	1100	100	0.44	500	50	10MΩ

#### TECHNICAL INFORMATION & PHYSICAL CHARACTERISTICS:

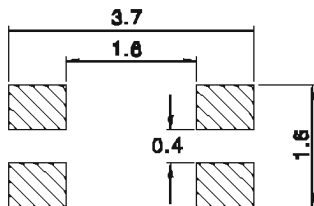
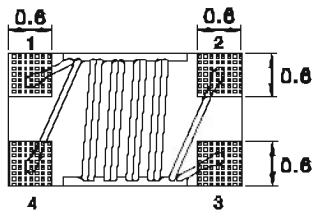
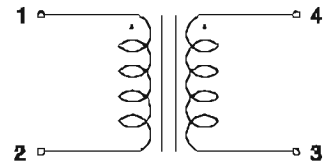
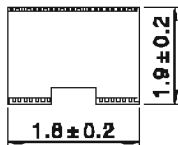
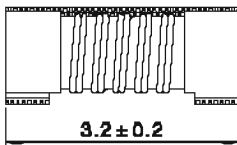

- Inductance Testing: 100MHz E4991A
- RDC: QuadTech 1880 Milliohm meter
- Operating temperature: -40°C to +85°C
- Storage Temperature: 40°C Max, 70% RH Max
- Resistance to soldering heat: 260°C for 10 seconds
- Marking: Part number

Note: All specifications subject to change without notice.

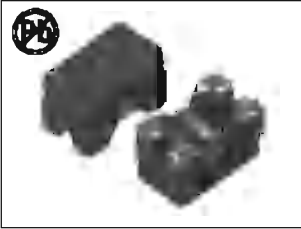

# SMD WIRE WOUND COMMON MODE FILTER

## SF3216 SERIES

### IMPEDANCE FREQUENCY:

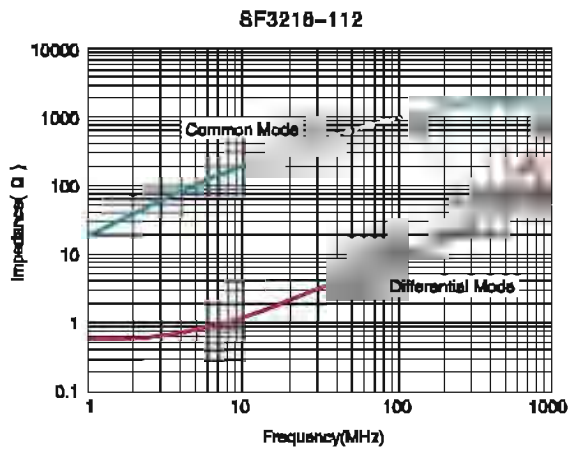
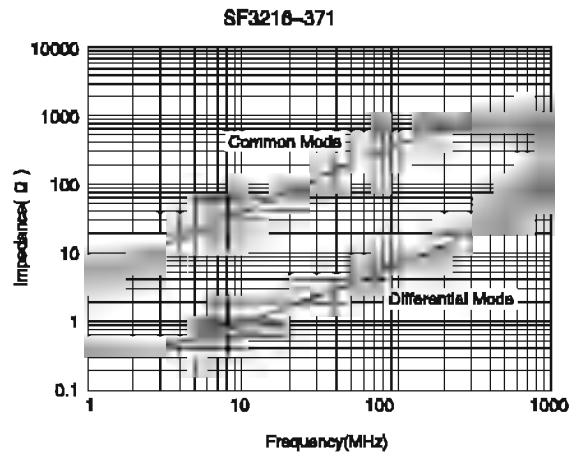
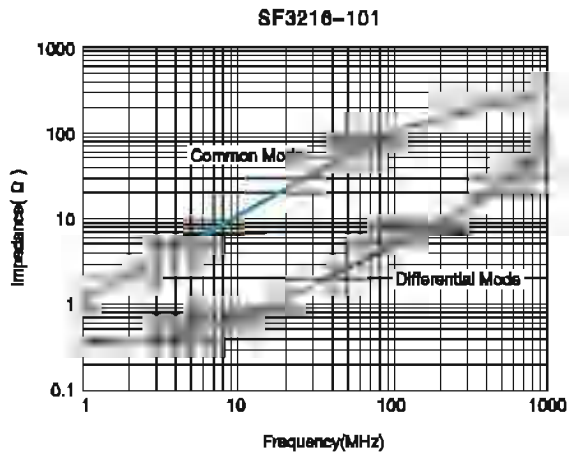

# AUTOMOTIVE SIGNAL COMMON MODE CHOKES SF4526F SERIES



## FEATURES:

- AEC-Q200 compliant, Grade 1
- PPAP ready and supported
- Manufactured in TS/IATF 16949 production lines
- Excellent impedance characteristics

## COMMON APPLICATIONS:

- Differential signal line common mode noise suppression.
- Multimedia devices
- Automotive applications such as ADAS, Infotainment, Sensing, TCU
- Automotive Ethernet

## ELECTRICAL CHARACTERISTICS:@25°C

Part Number	Inductance (uH)+50%/-30% 100KHz	Rated current (A)	DCR (mΩ)	Rated voltage (Vdc)	Insulation Resistance (MΩ) Min
SF4526F-110Y	11	0.36	500	50	10
SF4526F-220Y	22	0.31	800	50	10
SF4526F-510Y	51	0.23	1000	50	10
SF4526F-101Y	100	0.20	2000	50	10

## PHYSICAL CHARACTERISTICS:

## WINDING:

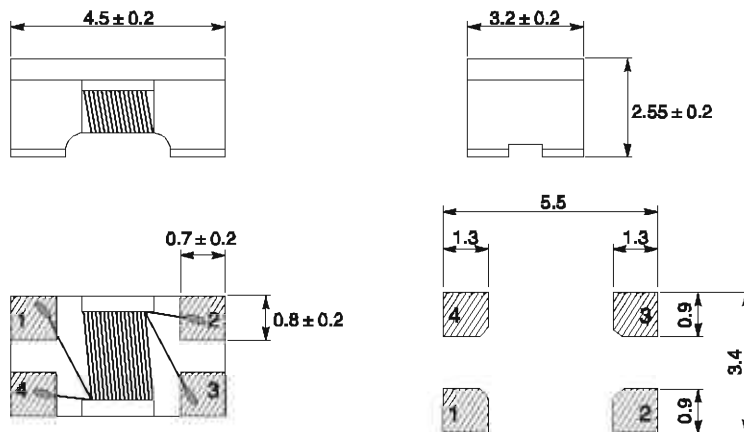

## GENERAL SPECIFICATIONS:

- Rated Current is based on an I<sub>rms</sub> temperature rise of 20 °C
- Inductance Test Conditions: 0.1V, 100KHz
- SF4526F Series is AEC-Q200 Automotive certified
- SF4526F Series is RoHS Compliant and Pb free
- Operating Temperature: -40 °C to +150 °C (Temperature rise included)
- Storage Temperature(on PCB): -40 °C to +150 °C
- Storage (in original packaging): <40 °C , <70% RH
- Packaging: Tape & Reel is standard (Qty: 500PCS)

Note:All specifications subject to change without notice.

# AUTOMOTIVE SIGNAL COMMON MODE CHOKES SF4526F SERIES



## FREQUENCY VS IMPEDANCE

SF4526F-110Y

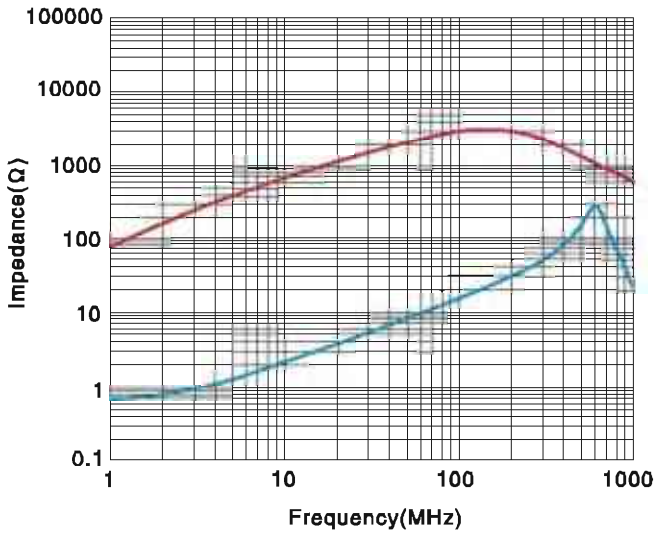

SF4526F-220Y

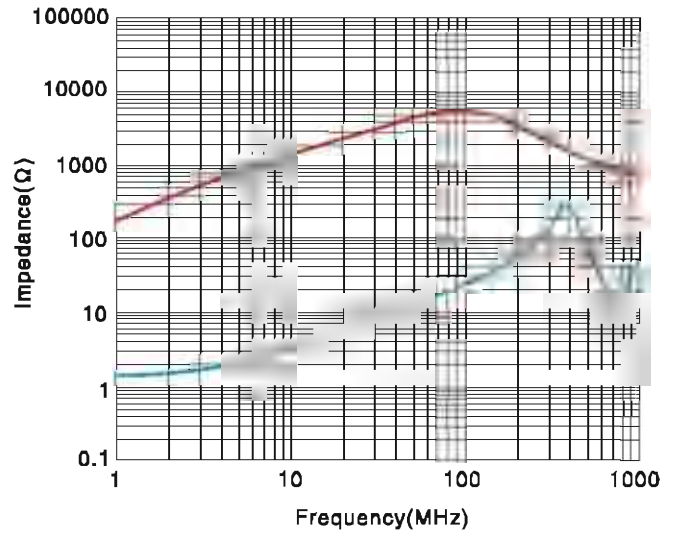

SF4526F-510Y

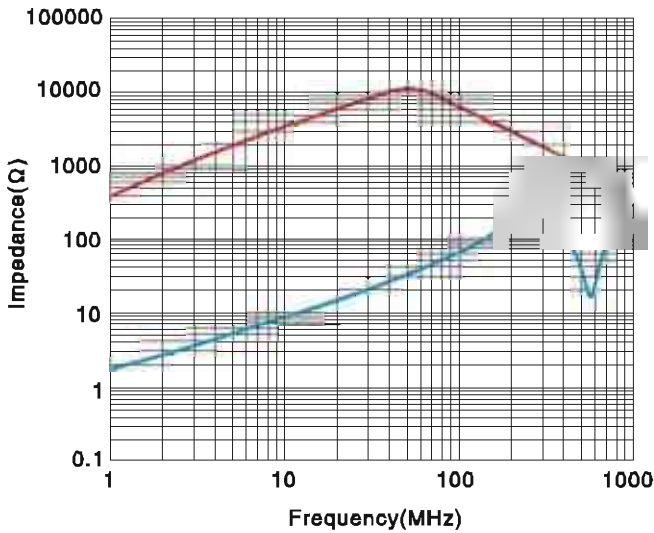

SF4526F-101Y

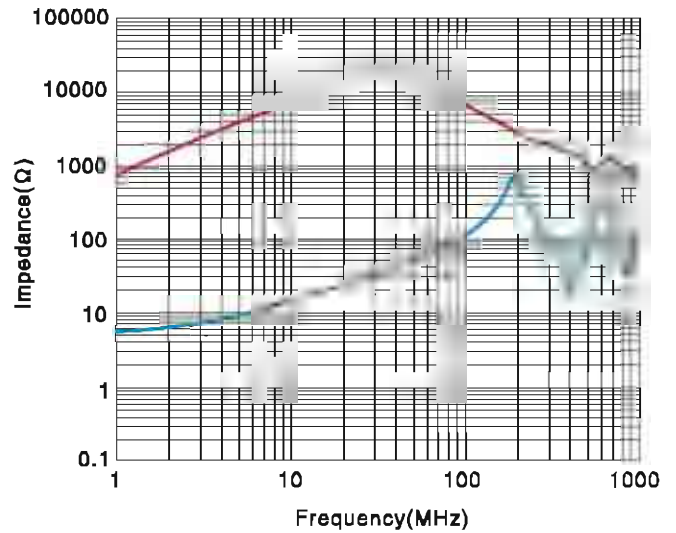

— Com — Dif

# AUTOMOTIVE SIGNAL COMMON MODE CHOKES SF4528F SERIES

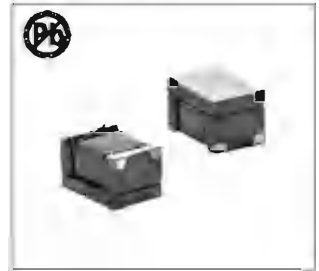

## FEATURES:

- AEC-Q200 compliant
- PPAP ready and supported
- Manufactured in TS/IATF 16949 production lines
- Excellent impedance characteristics

## COMMON APPLICATIONS:

- Differential signal line common mode noise suppression.
- Multimedia devices
- Automotive applications such as ADAS, Infotainment, Sensing, TCU
- Automotive Ethernet

## ELECTRICAL CHARACTERISTICS:@25°C

Part Number	Inductance (uH)+50%/-30% 100KHz	Impedance Z(Ω)@10MHz		Rated current (A)	DCR (mΩ)	Rated voltage (Vdc)
		Min	Typ			
SF4528F-110Y	11	300	600	0.36	600	50
SF4528F-220Y	22	500	1200	0.31	1000	50
SF4528F-510Y	51	1000	2800	0.23	1000	50
SF4528F-101Y	100	2000	5800	0.20	2000	50

## PHYSICAL CHARACTERISTICS:

## WINDING:

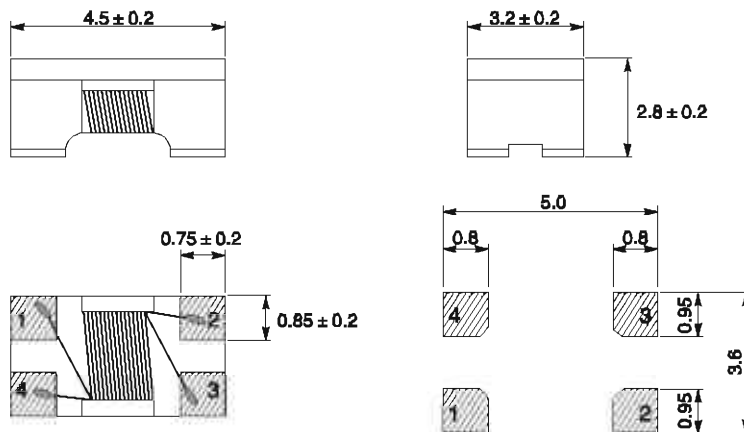

## GENERAL SPECIFICATIONS:

- Rated Current is based on an I<sub>rms</sub> temperature rise of 40 °C
- Inductance Test Conditions: 0.1V, 100KHz
- SF4528F Series is AEC-Q200 Automotive certified
- SF4528F Series is RoHS Compliant and Pb free
- Operating Temperature: -55 °C to +150 °C (Temperature rise included)
- Storage Temperature(on PCB): -55 °C to +150 °C
- Storage (in original packaging): <40 °C , <60% RH
- Packaging: Tape & Reel is standard (Qty: 500PCS)

Note:All specifications subject to change without notice.

# AUTOMOTIVE SIGNAL COMMON MODE CHOKES SF4528F SERIES



## FREQUENCY VS IMPEDANCE

SF4528F-110Y

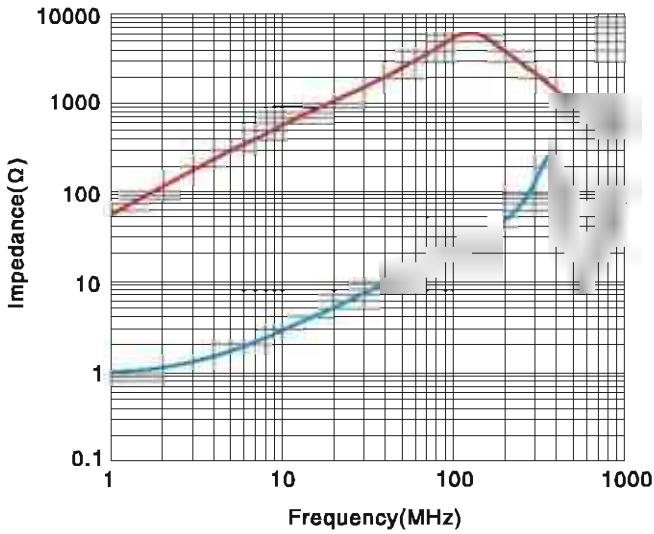

SF4528F-220Y

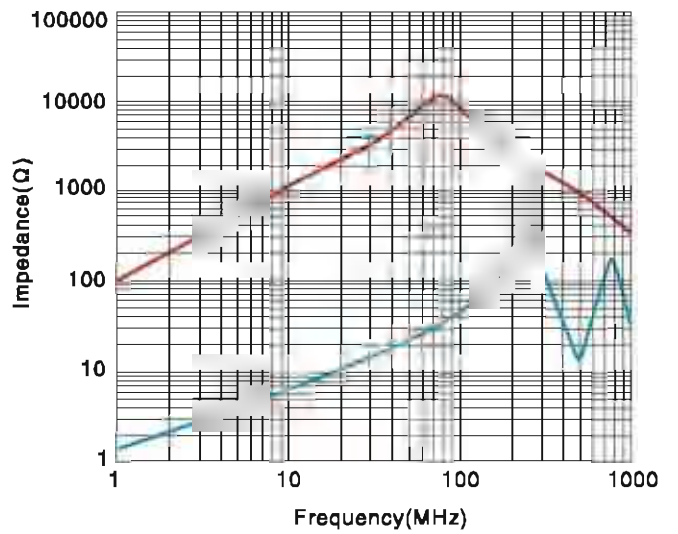

SF4528F-510Y

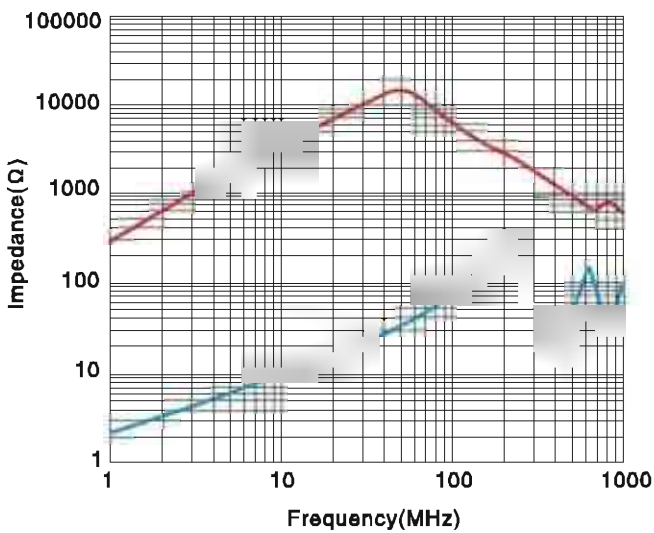

SF4528F-101Y

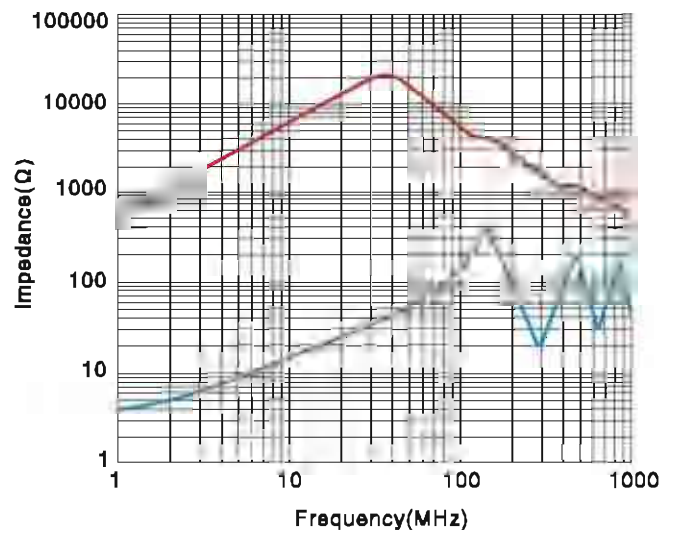

— Com — Dif

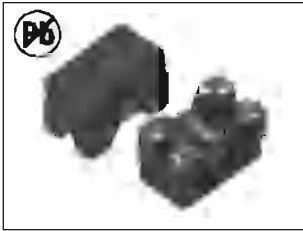

## SMD WIRE WOUND COMMON MODE FILTER SF4532 SERIES

### FEATURES:

- High common mode impedance at high frequency effects excellent noise suppression performance.

### APPLICATIONS:

- Common mode noise suppression of signal lines in high speed and high density digital equipment such as personal computers and peripherals.

### ELECTRICAL CHARACTERISTICS:

Part Number	Impedance ( $\Omega$ ) $\pm 25\%$	Test frequency (MHz)	DCR ( $\Omega$ ) Max	Rated Current (A) Max	Rated Voltage (V)	Insulation resistance (Min)
SF4532-800	80	100	0.07	3.0	50	10M $\Omega$
SF4532-121	120	100	0.07	3.0	50	10M $\Omega$
SF4532-201	200	100	0.10	2.0	50	10M $\Omega$
SF4532-601	600	100	0.30	1.5	50	10M $\Omega$
SF4532-801	800	100	0.35	1.0	50	10M $\Omega$
SF4532-102	1000	100	0.40	1.0	50	10M $\Omega$

### TECHNICAL INFORMATION & PHYSICAL CHARACTERISTICS:

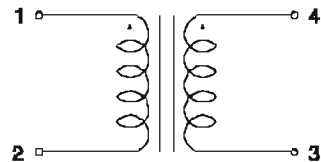
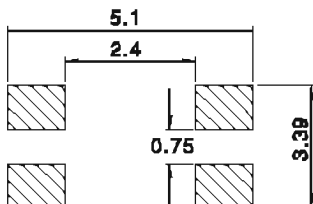
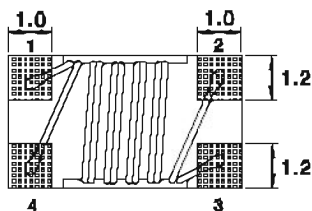
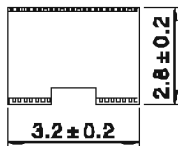
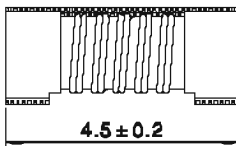

- Inductance Testing: 100MHz E4991A
- RDC: QuadTech 1880 Milliohm meter
- Operating temperature:  $-40^{\circ}\text{C}$  to  $+85^{\circ}\text{C}$
- Storage Temperature:  $40^{\circ}\text{C}$  Max, 70%RH Max
- Resistance to soldering heat:  $260^{\circ}\text{C}$  for 10 seconds
- Marking: Part number

Note: All specifications subject to change without notice.

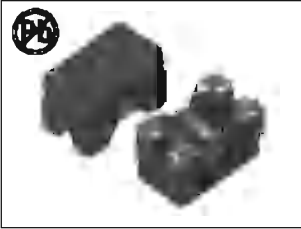

# SMD WIRE WOUND COMMON MODE FILTER

## SF4532 SERIES

### IMPEDANCE FREQUENCY:

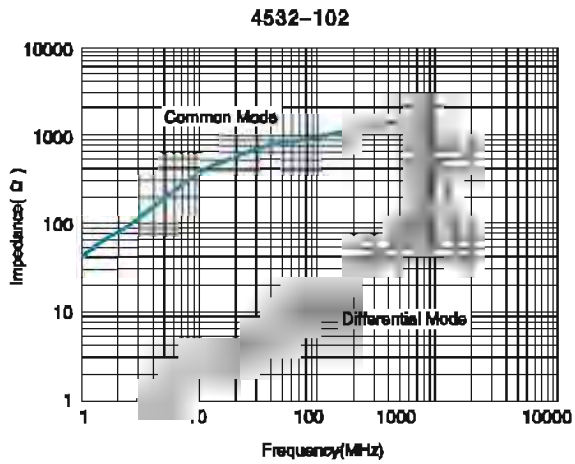
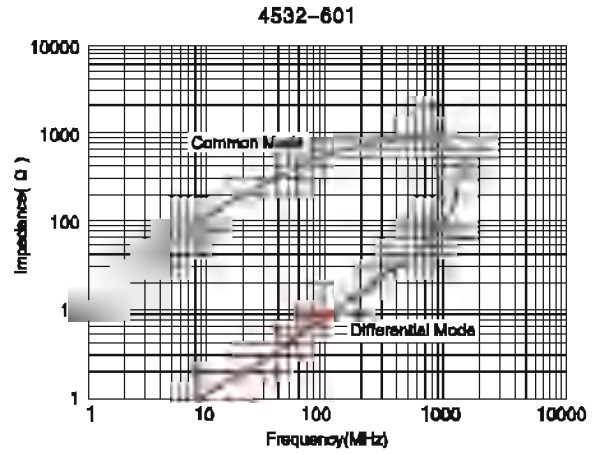
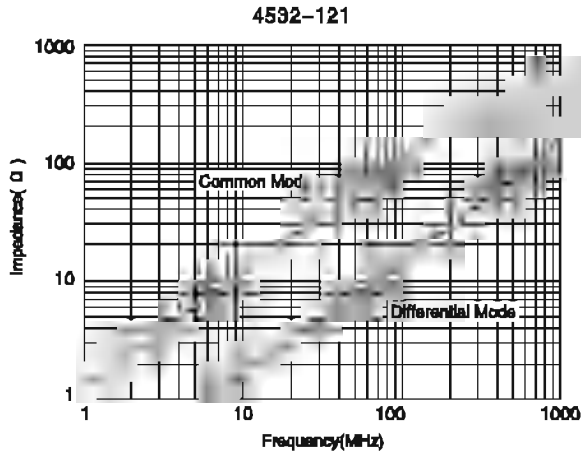

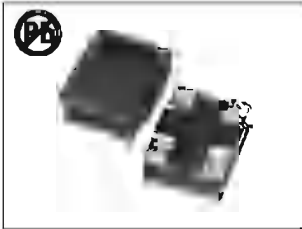

## SMD WIRE WOUND COMMON MODE FILTER SF5045 SERIES

### FEATURES:

- High common mode Impedance at high frequency effects excellent noise suppression performance.

### APPLICATIONS:

- Common mode noise suppression of signal lines in high speed and high density digital equipment such as personal computers and peripherals.

### ELECTRICAL CHARACTERISTICS:

Part Number	Impedance ( $\Omega$ )typ.	Test frequency (MHz)	DCR (m $\Omega$ ) Max	Rated Current (A) Max	Rated Voltage (V)	Insulation resistance (Min)
SF5045-101	100	100	9	6	50	10M $\Omega$
SF5045-251	250	100	14	5	50	10M $\Omega$
SF5045-501	500	100	19	4	50	10M $\Omega$
SF5045-102	1000	100	24	3	50	10M $\Omega$
SF5045-142	1400	100	40	1.5	50	10M $\Omega$

### TECHNICAL INFORMATION & PHYSICAL CHARACTERISTICS:

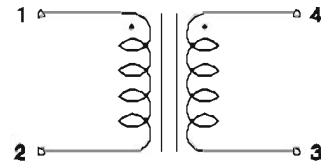
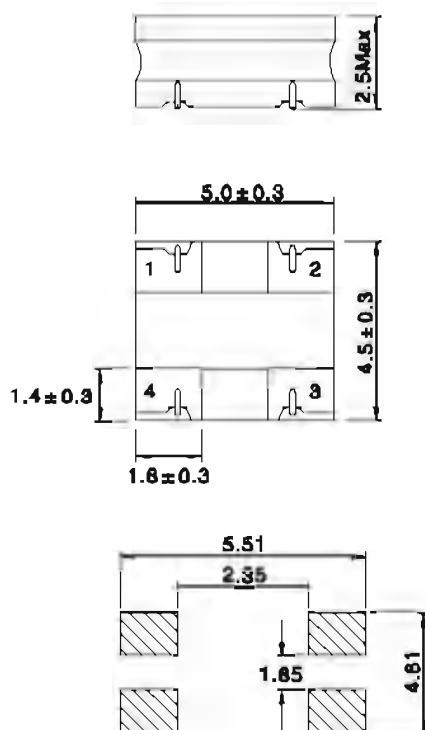

- Inductance Testing: 100MHz E4991A
- RDC: QuadTech 1880 Milliohm meter
- Operating temperature:  $-40^{\circ}\text{C}$  to  $+85^{\circ}\text{C}$
- Storage Temperature:  $40^{\circ}\text{C}$  Max, 70%RH Max
- Resistance to soldering heat:  $260^{\circ}\text{C}$  for 10 seconds
- Marking: Part number

Note: All specifications subject to change without notice.

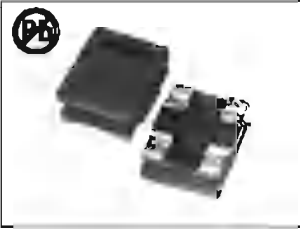

# SMD WIRE WOUND COMMON MODE FILTER SF5045 SERIES

## IMPEDANCE FREQUENCY:

### Common Mode

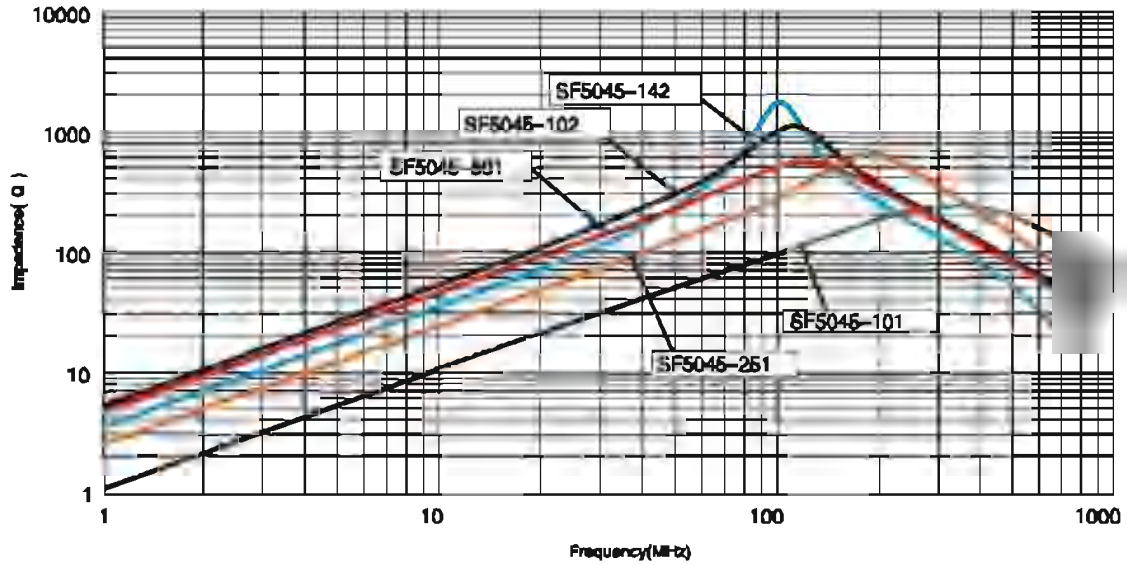

### Differential Mode

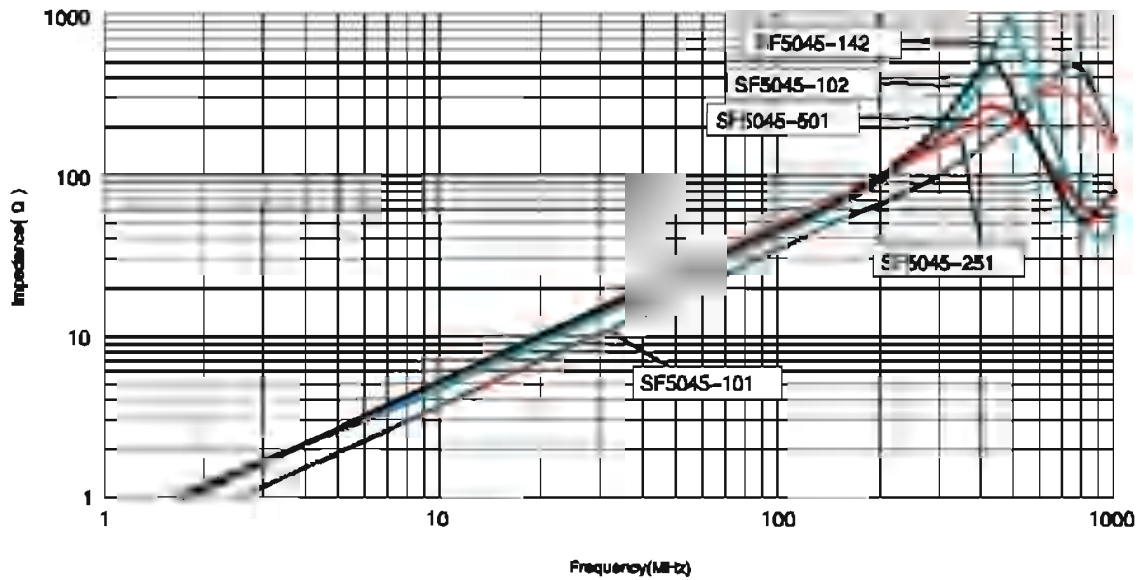

# AUTOMOTIVE SIGNAL COMMON MODE CHOKES SF6527F SERIES

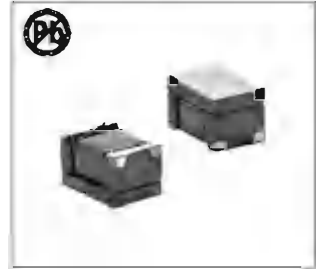

## FEATURES:

- AEC-Q200 compliant, Grade 1
- PPAP ready and supported
- Manufactured in TS/IATF 16949 production lines
- Excellent impedance characteristics

## COMMON APPLICATIONS:

- Differential signal line common mode noise suppression.
- Multimedia devices
- Automotive applications such as ADAS, Infotainment, Sensing, TCU
- Automotive Ethernet

## ELECTRICAL CHARACTERISTICS:@25°C

Part Number	Inductance (uH)+50%/-30% 100KHz	Rated current (A)	DCR (mΩ)	Return loss(dB) Min				
				1-10MHz	30MHz	60MHz		
SF6527F-101Y	100	0.35	2000	-28	-23	-18		
Insertion loss(dB) Max		Common mode Rejection(dB) Min				Differential to common mode Rejection (dB) Min		
1-60MHz	100MHz	1MHz	10MHz	60-100MHz	200-1000MHz	1-10MHz	100MHz	1000MHz
-1.0	-3.0	-18	-35	-43	-30	-70	-50	-25

## PHYSICAL CHARACTERISTICS: WINDING:

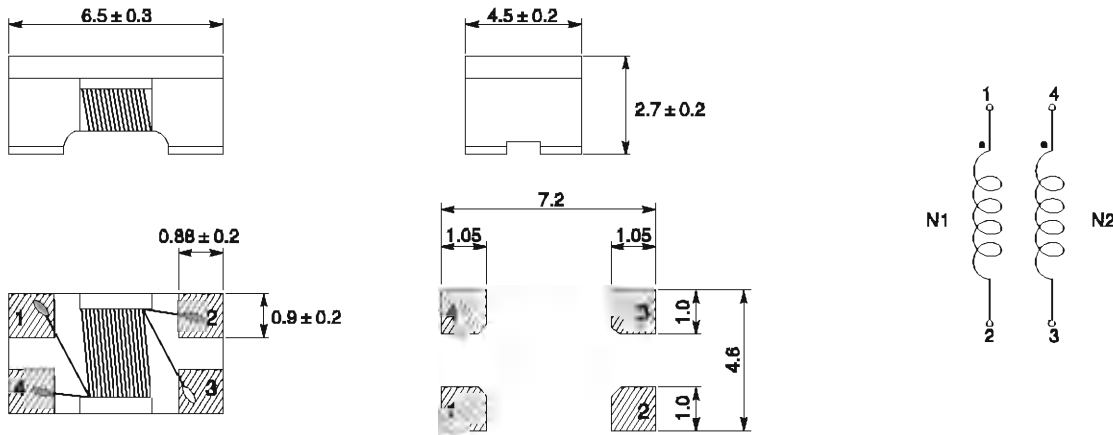

## GENERAL SPECIFICATIONS:

- Rated Current is based on an I<sub>rms</sub> temperature rise of 40 °C
- Inductance Test Conditions: 0.1V, 100KHz
- SF6527F Series is AEC-Q200 Automotive certified
- SF6527F Series is RoHS Compliant and Pb free
- Operating Temperature: -40 °C to +125 °C (Temperature rise included)
- Storage Temperature(on PCB): -40 °C to +125 °C
- Storage (in original packaging): <40 °C , <60% RH

Note:All specifications subject to change without notice.

# SURFACE-MOUNT COMMON MODE CHOKES

## SQD 32T,45T SERIES

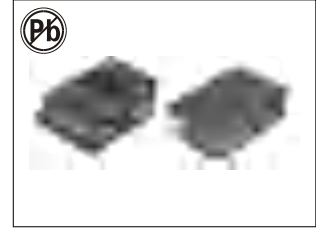

### FEATURES:

- Ferrite Core bobbin construction
- High frequency and Large current
- Excellent Mechanical Strength
- Excellent Solderability
- Excellent Frequency performance
- Low Profile and Low cost

### OPTIONS:

- Packaging:Tape & Reel is standard (Qty:2000pcs)
- Bulk packaging available for smaller quantities
- Tolerance:20% is standard, tighter tolerances available

### COMMON APPLCATIONS:

- DC/DCAC/DC convertor
- Video Cameras
- Communication System
- Automotive Systems
- Liquid Crystal Televisions
- Hard Disk Drives
- Network Systems
- Computer Peripheral Equipment

## ELECTRICAL CHARACTERISTICS: PHYSICAL CHARACTERISTICS:

Part Number	Common Mode Impedance@100MHz (Ω)Typical	IDC (A)Max	DCR (mΩ)Max
SQD32T01-800	80	0.6	0.08
SQD32T01-121	120	0.6	0.1
SQD32T01-221	220	0.5	0.12
SQD32T02-800	80	0.6	0.08
SQD32T02-121	120	0.6	0.1
SQD32T02-221	220	0.5	0.12
SQD45T01-121	120	1.0	0.05
SQD45T01-331	330	1.0	0.08
SQD45T01-701	700	0.8	0.1
SQD45T02-121	120	1.0	0.05
SQD45T02-331	330	1.0	0.08
SQD45T02-701	700	0.8	0.1

01 Seires shape

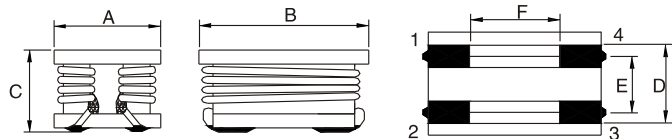

02 Seires shape

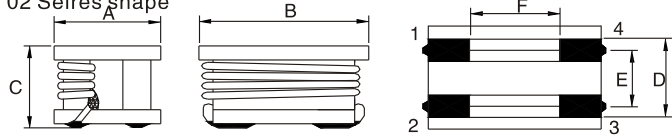

Type	A	B	C	D	E	F
SQD32T	3.2 ± 0.3	2.5 ± 0.3	2.2 ± 0.3	1.6	0.6	1.2
SQD45T	4.5 ± 0.3	3.2 ± 0.3	3.2 ± 0.3	2.5	1.2	1.5

Note:1. K= ± 10%,M= ± 20%,N= ± 30%

## WINDING:

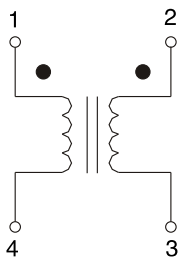

- Z test with HP4191A or HP4395A
- RDC:QuadTech 1880 Milliohmeter
- Operating temperature: -40°C to +105°C
- Storage Temperature: -40°C to +105°C
- Resistance to soldering heat:260°C for 10 seconds
- Marking: Part number and date code

Note:All specifications subject to change without notice.

# SURFACE-MOUNT COMMON MODE CHOKES

## SQD 55T,60T,80T,85T,100T SERIES

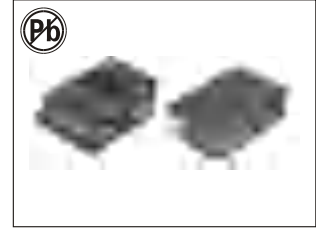

### FEATURES:

- Ferrite Core bobbin construction
- High frequency and Large current
- Excellent Mechanical Strength
- Excellent Solderability
- Excellent Frequency performance
- Low Profile and Low cost

### OPTIONS:

- Packaging:Tape & Reel is standard (Qty:2000pcs)
- Bulk packaging available for smaller quantities
- Tolerance:20% is standard, tighter tolerances available

### COMMON APPLCATIONS:

- DC/DCAC/DC convertor
- Video Cameras
- Communication System
- Automotive Systems
- Liquid Crystal Televisions
- Hard Disk Drives
- Network Systems
- Computer Peripheral Equipment

### ELECTRICAL CHARACTERISTICS:

Part Number	Common Mode Impedance (Ω)Typical			IDC (A)Max	DCR (mΩ)Max
	1MHz	50MHz	100MHz		
SQD55T-151	15.0	100.0	150.0	2.0	60.0
SQD55T-351	50.0	350.0	350.0	2.0	70.0
SQD60T-601	70.0	500.0	600.0	2.0	45.0
SQD60T-701	75.0	600.0	700.0	2.0	50.0
SQD80T-701	20.0	400.0	700.0	4.0	40.0
SQD80T-901	40.0	600.0	900.0	4.0	45.0
SQD85T-203	50.0	2200.0	2000.0	2.5	75.0
SQD100T-801	80.0	850.0	800.0	5.0	25.0
SQD100T-102	90.0	900.0	1000.0	5.0	35.0
SQD100T-122	150.0	1100.0	1200.0	5.0	45.0

Note:1. K=± 10%,M=± 20%,N=± 30%

### PHYSICAL CHARACTERISTICS:

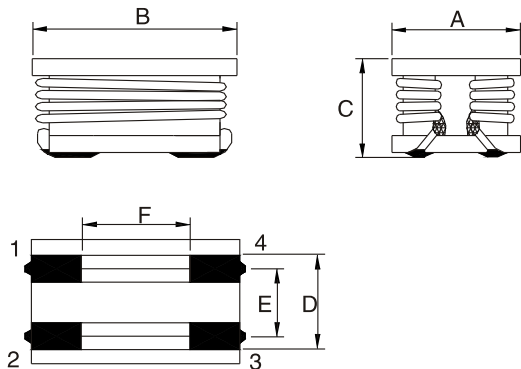

### WINDING:

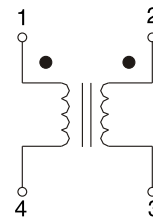

Type	A	B	C	D	E	F
SQD55T	5.5 ± 0.3	4.6 ± 0.3	1.6 ± 0.3	4.6	2.7	2.2
SQD60T	6.0 ± 0.3	7.5 ± 0.3	3.2 ± 0.3	7.5	2.0	1.8
SQD80T	8.0 ± 0.3	10.0 ± 0.3	5.0 ± 0.3	10.0	4.0	2.5
SQD85T	8.5 ± 0.3	5.0 ± 0.3	5.0 ± 0.3	5.0	1.8	4.0
SQD100T	10.0 ± 0.3	12.0 ± 0.3	6.0 ± 0.3	12.0	4.8	3.5

- Z test with HP4191A or HP4395A
- RDC:QuadTech 1880 Milliohm meter
- Operating temperature: -40°C to +105°C
- Storage Temperature: -40°C to +105°C
- Resistance to soldering heat:260°C for 10 seconds
- Marking: Part number and date code

Note:All specifications subject to change without notice.

# SURFACE-MOUNT COMMON MODE CHOKES

## SQD 75T,83T,105T,125T SERIES

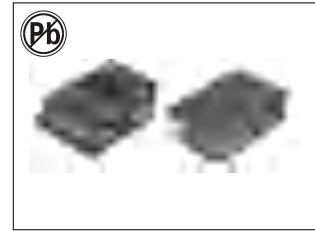

### FEATURES:

- Ferrite Core bobbin construction
- High frequency and Large current
- Excellent Mechanical Strength
- Excellent Solderability
- Excellent Frequency performance
- Low Profile and Low cost

### OPTIONS:

- Packaging:Tape & Reel is standard (Qty:2000pcs)
- Bulk packaging available for smaller quantities
- Tolerance:20% is standard, tighter tolerances available

### COMMON APPLCATIONS:

- DC/DCAC/DC convertor
- Video Cameras
- Communication System
- Automotive Systems
- Liquid Crystal Televisions
- Hard Disk Drives
- Network Systems
- Computer Peripheral Equipment

### ELECTRICAL CHARACTERISTICS:

Part Number	Common Mode Impedance@100MHz (Ω)Typical	IDC (A)Max	DCR (mΩ)Max
SQD75T-601	600	4.0	15
SQD75T-102	1000	3.0	17
SQD75T-122	1200	3.0	25
SQD75T-152	1500	2.0	40
SQD83T-501	500	3.0	18
SQD83T-801	800	2.0	28
SQD83T-102	1000	1.5	58
SQD105T-401	400	7.0	5
SQD105T-751	750	5.0	10
SQD105T-102	1000	4.0	15
SQD125T-901	900	10.0	10
SQD125T-102	1000	7.0	15
SQD125T-122	1200	5.0	25

Note:1. K= ± 10%,M= ± 20%,N= ± 30%

### TECHNICAL INFORMATION:

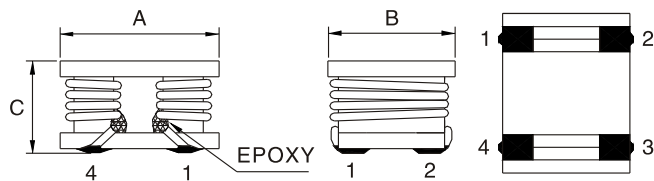

- Inductance Testing: 1KHz 1V HP4284A
- Z test with HP4191A or HP4395A
- RDC:QuadTech 1880 Milliohm meter
- Operating temperature: -40°C to +105°C
- Storage Temperature: -40°C to +105°C
- Resistance to soldering heat:260°C for 10 seconds
- Marking: Part number and date code

Note:All specifications subject to change without notice.

### PHYSICAL CHARACTERISTICS:

#### LAND PATTERNS

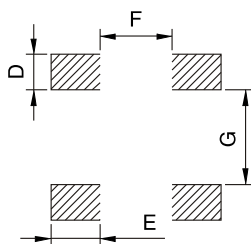

#### DIMENSIONS IN:mm

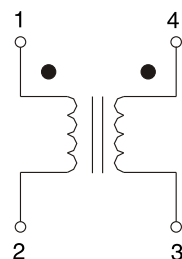

Type	A	B	C	D	E	F	G
SQD75T	7.5 ± 0.3	8.8 ± 0.3	5.0 ± 0.3	2.0	2.8	2.6	1.4
SQD83T	8.0 Max	6.5 Max	3.5 Max	2.0	2.0	2.0	2.6
SQD105T	10.5 Max	8.5 Max	5.5 Max	2.1	2.4	2.9	3.9
SQD125T	12.0 ± 0.3	10.0 ± 0.3	4.5 ± 0.3	2.6	3.0	3.0	4.4

# SURFACE-MOUNT COMMON MODE CHOKES

## SQD 1211 SERIES

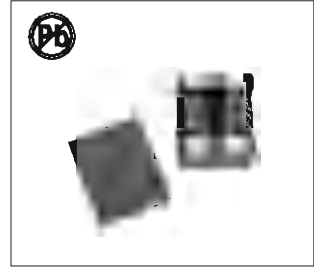

### FEATURES:

- Ferrite Core bobbin construction
- High frequency and Large current
- Excellent Mechanical Strength
- Excellent Solderability
- Excellent Frequency performance
- Low Profile and Low cost

### APPLICATIONS:

- DC/DCAC/DC converter
- Video Cameras
- Communication System
- Automotive Systems
- Liquid Crystal Televisions
- Hard Disk Drives
- Network Systems

## ELECTRICAL CHARACTERISTICS:

Part Number	Impedance@100MHz		DCR (mΩ)Max	IDC (A)Max
	(Ω)Min	(Ω)Typ		
SQD1211-800	80	230	2.0	10.0
SQD1211-701	500	700	6.0	8.0
SQD1211-801	600	800	8.0	8.0
SQD1211-102	750	1000	14.0	6.0
SQD1211-222	2200	2500	35.0	1.8
SQD1211-272	2300	2700	50.0	1.5

## PHYSICAL CHARACTERISTICS: WINDING:

DIMENSIONS IN:mm

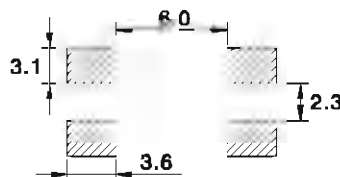
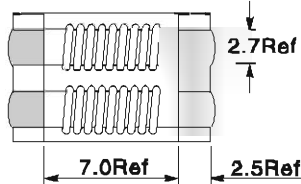
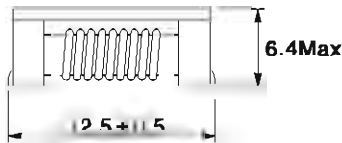
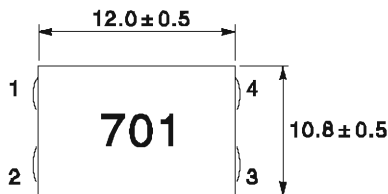

LAND PATTERNS

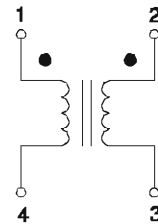

- Impedance test with HP4191A or HP4395A
- RDC:QuadTech 1880 Milliohm meter
- Rated voltage: 125V Max
- Insulation resistance: 10MΩ Min
- Operating temperature: -40°C to +125°C
- Storage Temperature: -40°C to +125°C
- Packing: 500Pcs/Reel/Bag  
1000Pcs/Box  
5000Pcs/Carton

# SURFACE-MOUNT COMMON MODE CHOKES

SQD1211-701

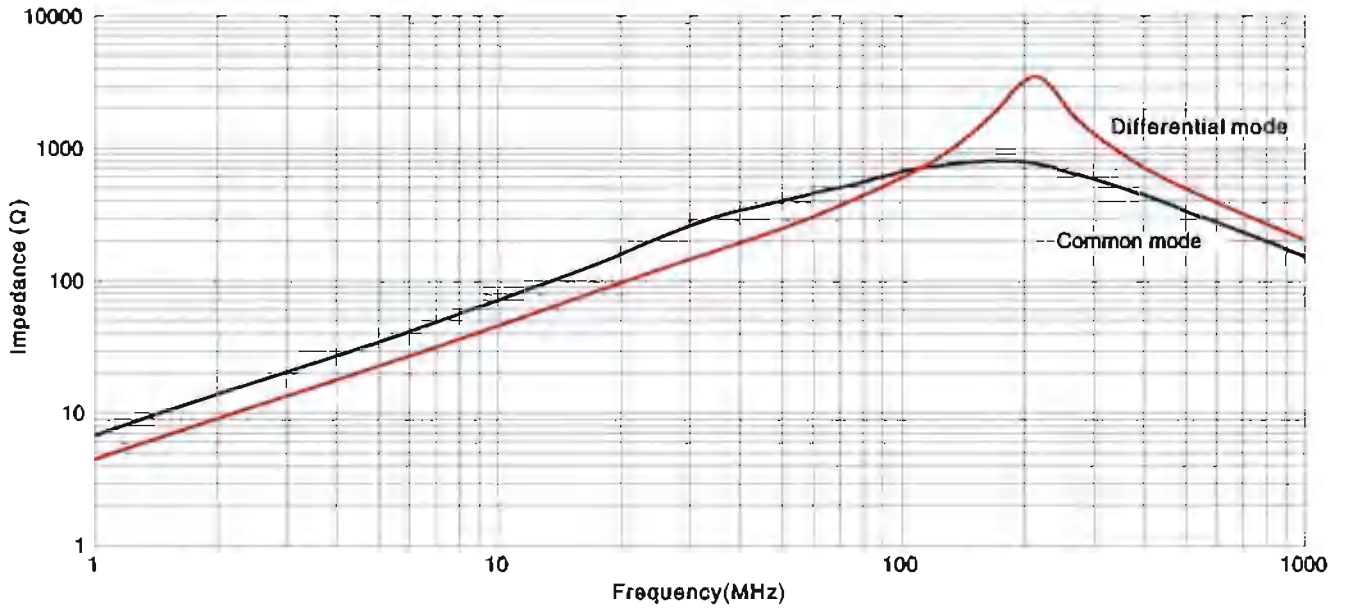

SQD1211-102

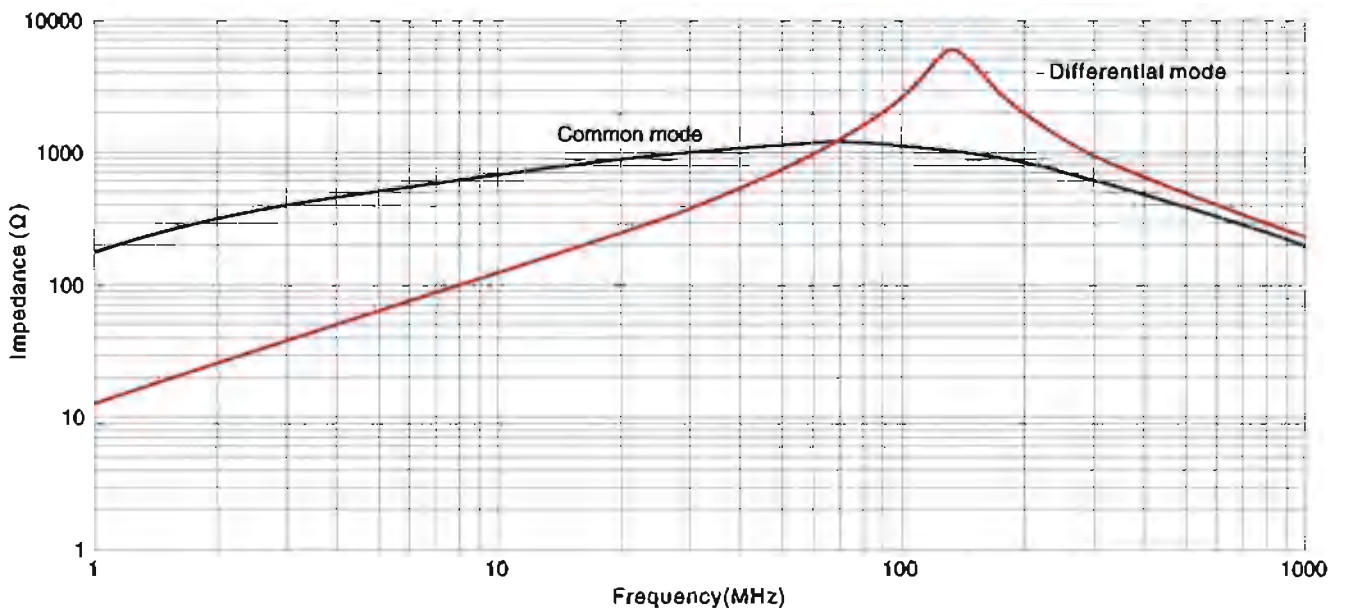

# SURFACE-MOUNT COMMON MODE CHOKES

## SQD 1513 SERIES

### FEATURES:

- Ferrite Core bobbin construction
- High frequency and Large current
- Excellent Mechanical Strength
- Excellent Solderability
- Excellent Frequency performance
- Low Profile and Low cost

### APPLICATIONS:

- DC/DCAC/DC converter
- Video Cameras
- Communication System
- Automotive Systems
- Liquid Crystal Televisions
- Hard Disk Drives
- Network Systems

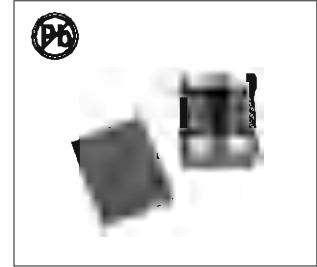

## ELECTRICAL CHARACTERISTICS:

Part Number	Impedance@100MHz		DCR (mΩ)Max	IDC (A)Max
	(Ω)Min	(Ω)Typ		
SQD1513-301H	225	300	4.0	15.0
SQD1513-301	225	300	5.0	13.0
SQD1513-551H	400	550	5.0	12.0
SQD1513-551	400	550	6.0	10.0
SQD1513-501	400	500	6.0	10.0
SQD1513-601	500	600	7.0	10.0
SQD1513-701	500	700	7.0	10.0
SQD1513-102	800	1000	10.0	9.0
SQD1513-152	1200	1500	23.0	5.0

## PHYSICAL CHARACTERISTICS: WINDING:

DIMENSIONS IN:mm

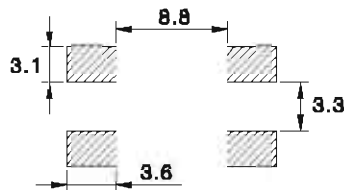
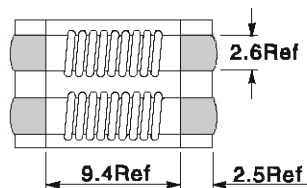
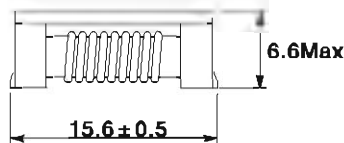
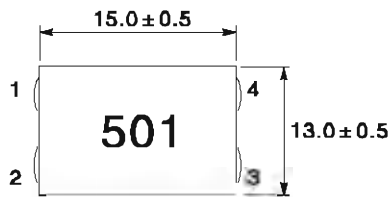

LAND PATTERNS

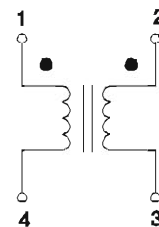

- Impedance test with HP4191A or HP4395A
- RDC:QuadTech 1880 Milliohm meter
- Rated voltage: 80V Max
- Insulation resistance: 10MΩ Min
- Operating temperature: -40°C to +125°C
- Storage Temperature: -40°C to +125°C
- Packing: 350Pcs/Reel  
700Pcs/Bag/Box  
3500Pcs/Carton

# SURFACE-MOUNT COMMON MODE CHOKES

SQD1513-301H

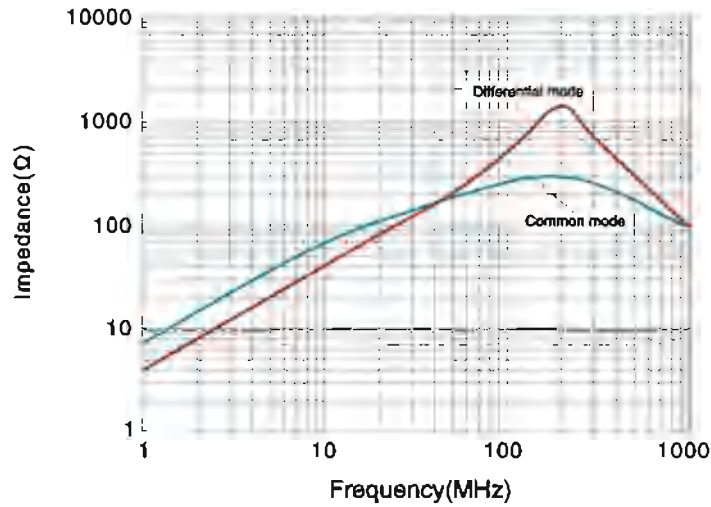

SQD1513-301

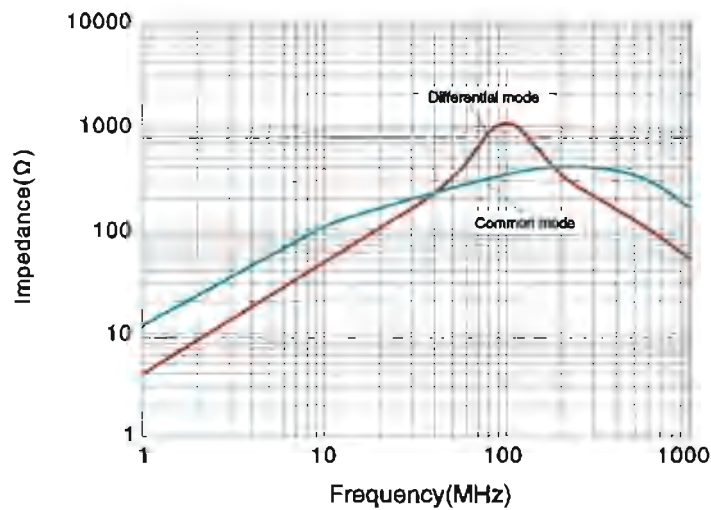

SQD1513-551H

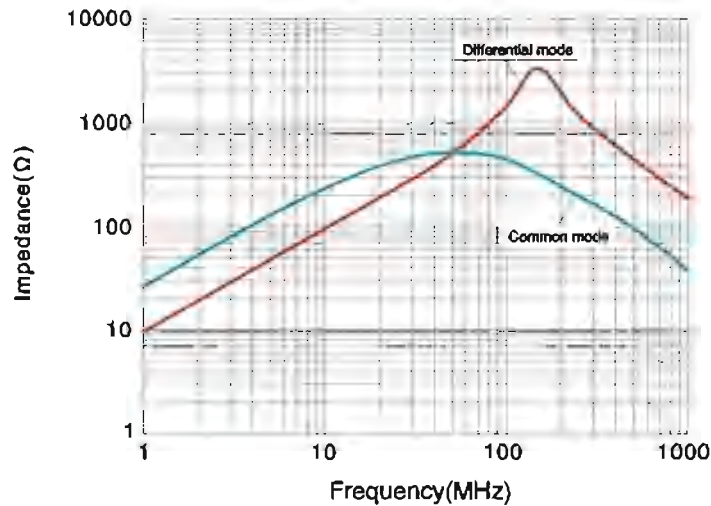

# SURFACE-MOUNT COMMON MODE CHOKES

SQD1513-551

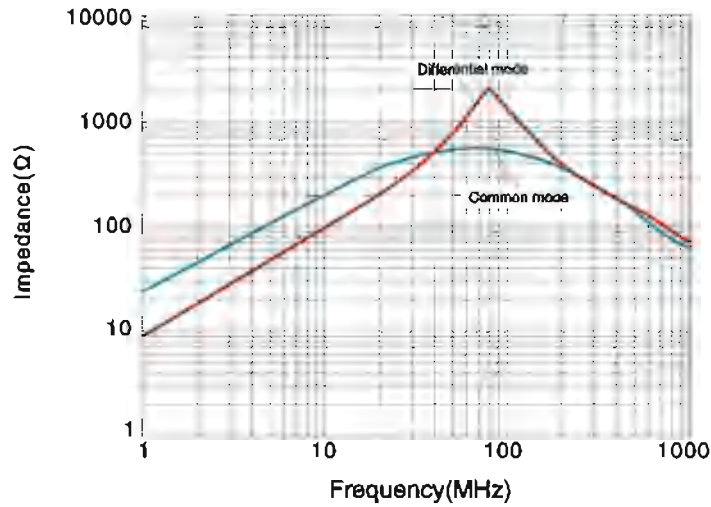

SQD1513-701

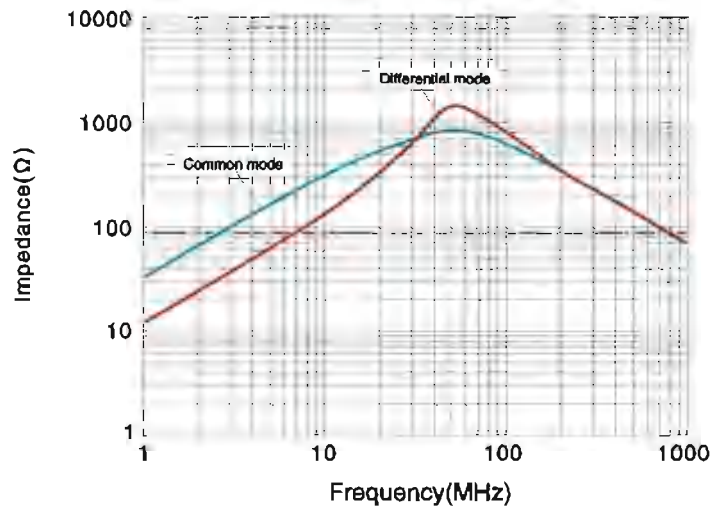

SQD1513-102

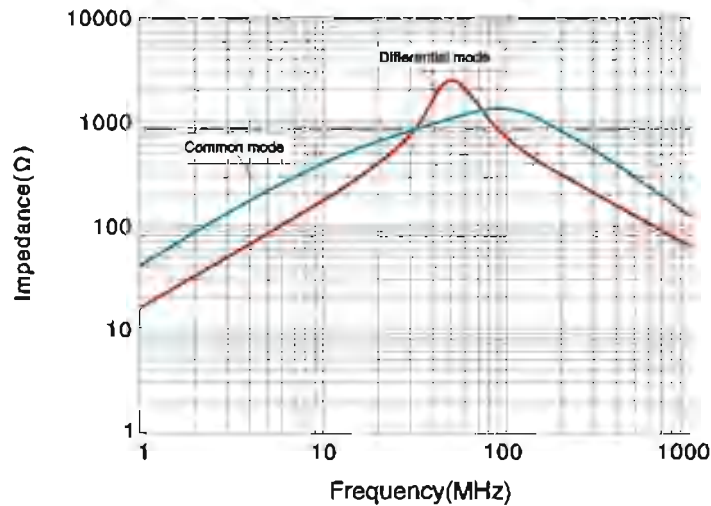

# SURFACE-MOUNT COMMON MODE CHOKES

SQD1513-152

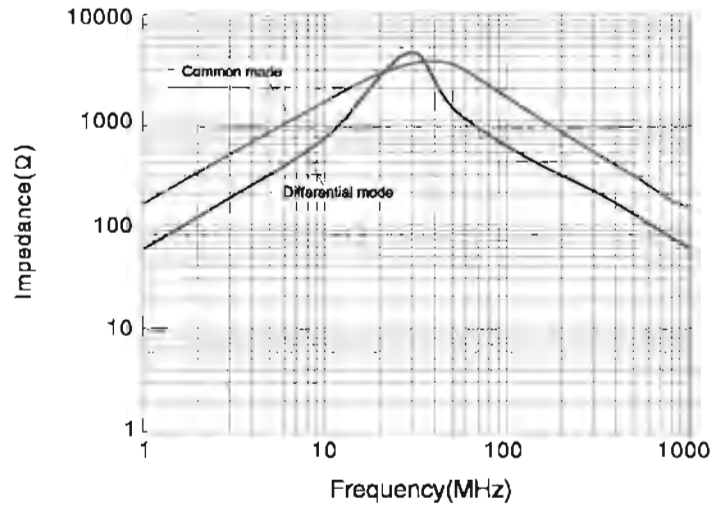

# COMMON MODE CHOKE COILS FOR DC POWER LINE

## SQD 3225, 4532 SERIES



### FEATURES:

- A chip-type common mode filter for large current applications. Common mode impedance surpasses 300 to 1000Ω at 100MHz. Noise is greatly suppressed.
- Capable of handling the highest current (up to 10A) of any chip-type common mode filter.
- Height and size have been considered, resulting in a compact and light-weight choke coil. Applicable for the miniaturization required to reduce the size and weight of portable equipment.
- The products contain no lead and also support lead-free soldering.
- This product does not contain regulated substances that are slated to be included in RoHS.

### APPLCATIONS:

- Used for power line noise suppression for any electronic devices. Used to counter adapter/battery line noise for relatively large elec-tronic devices such as notebook PCs, stand-alone word proces-sors, etc.

## ELECTRICAL CHARACTERISTICS:

Part Number	Impedance @ 100MHz (Common mode test)		DCR (mΩ)Max	Rated current (A)Max	Rated voltage (VDC)Max	Insulation resistance (MΩ)Min
	(Ω)Min	(Ω)Typ				
SQD3225-601	450	600	200	1.0	50	10
SQD4532-801	450	600	100	1.5	50	10
SQD4532-801	600	800	100	1.0	50	10

## PHYSICAL CHARACTERISTICS: WINDING:

DIMENSIONS IN:mm

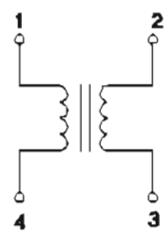
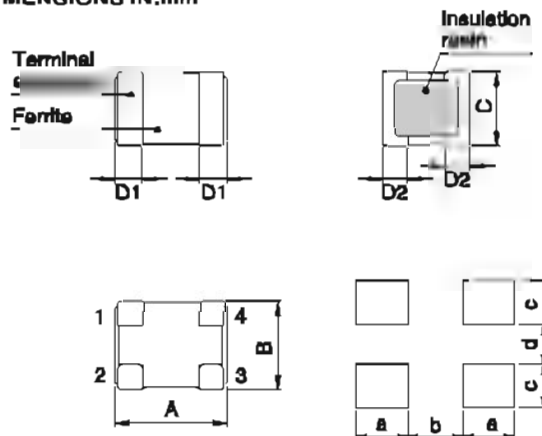

LAND PATTERNS

	A	B	C	D1	D2	a	b	c	d
SQD3225	3.2 ± 0.2	2.5 ± 0.2	2.3Max	0.7	0.65	1.5	1.6	1.4	1.1
SQD4532	4.5 ± 0.2	3.2 ± 0.2	3.0Max	1	1	1.8	2.3	1.75	1.1

- Impedance test with HP4191A or HP4395A
- RDC:QuadTech 1880 Milliohm meter
- Insulation resistance: 10MΩ Min
- Operating temperature: -40°C to +125°C
- Storage Temperature: -40°C to +125°C
- Packing: SQD3225: φ 180mm, 1000Pcs/Reel  
 φ 330mm, 5000Pcs/Reel  
 SQD4532: φ 180mm, 500Pcs/Reel  
 φ 330mm, 2000Pcs/Reel

# COMMON MODE CHOKE COILS FOR DC POWER LINE

SQD3225-601

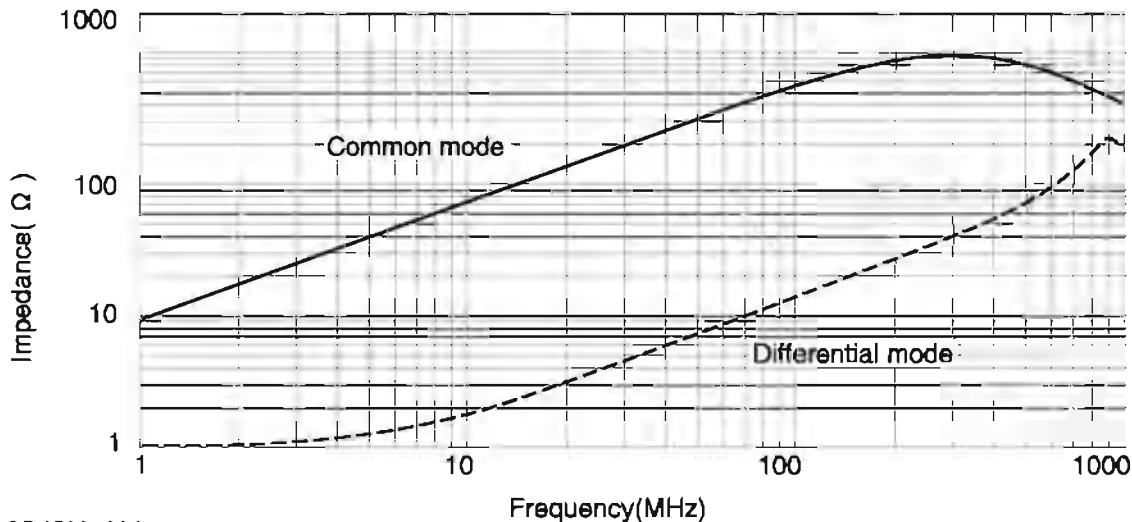

SQD4532-601

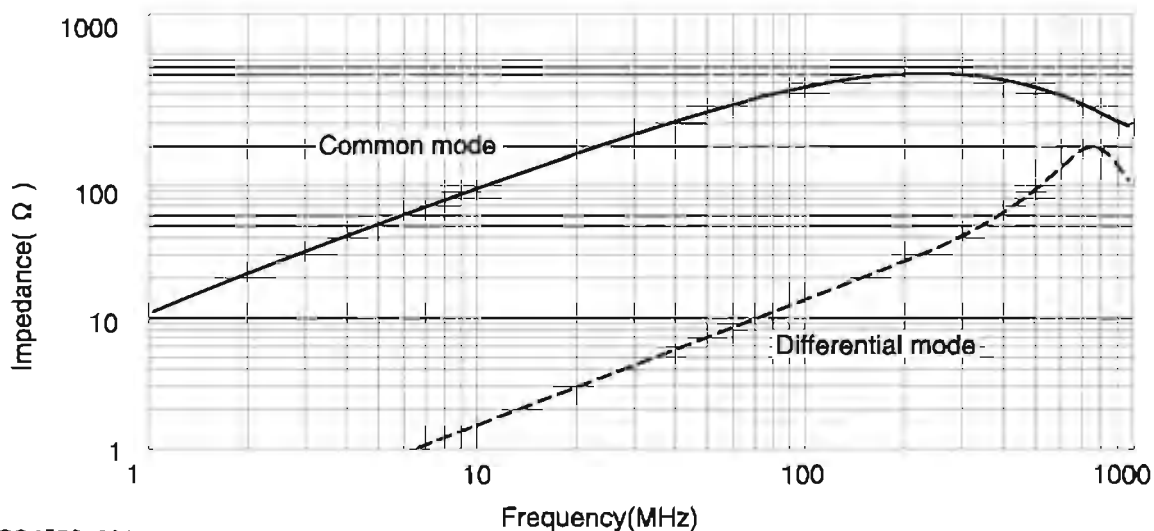

SQD4532-801

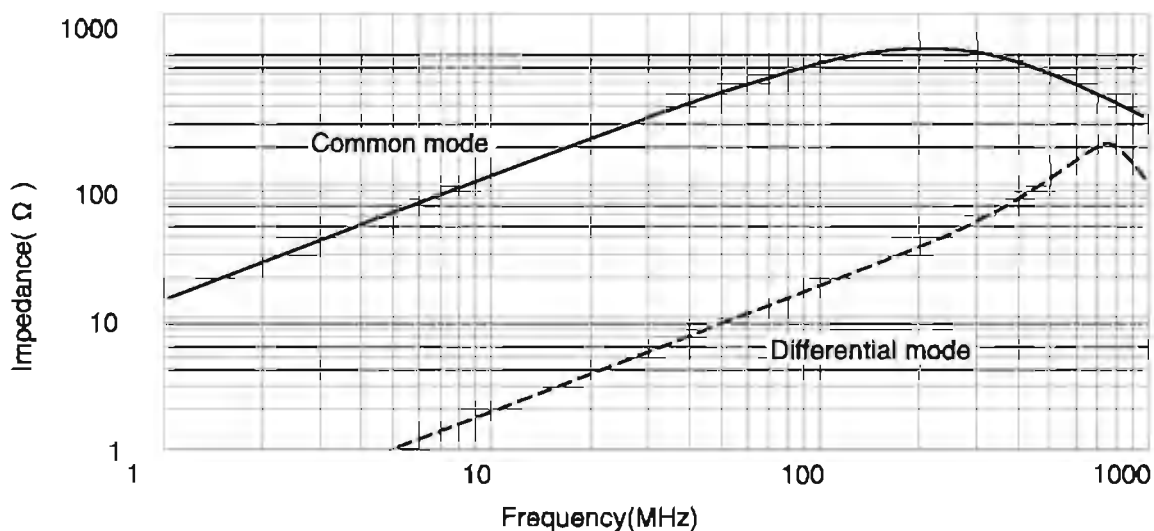

# SURFACE-MOUNT COMMON MODE CHOKES

## SQD 7060, 9070 SERIES

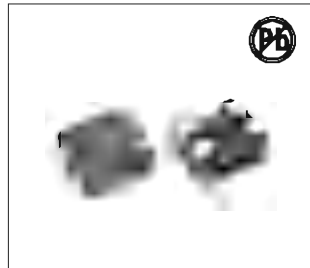

### FEATURES:

- Chip common mode filter for large current applications. There is excellent common mode impedance and noise suppression in a compact case
- Compatible with high-density portable devices, which are always being made smaller and lighter, because the height has been reduced.

### APPLCATIONS:

- Power line noise countermeasure for various electronic equipment.
- Noise countermeasure for adapter lines and battery lines or larger electronic equipment such as note book PCs and word processors.

## ELECTRICAL CHARACTERISTICS:

Part Number	Impedance @ 100MHz (Common mode test)		DCR (1 line) (mΩ)Max	Rated current (A)Max	Rated voltage (VDC)Max	Insulation resistance (MΩ)Min
	(Ω)Min	(Ω)Typ				
SQD7060-400	40	70	5	15	125	10
SQD7060-101	100	140	10	9	125	10
SQD7060-301	225	300	10	5	125	10
SQD7060-701	500	700	15	4	125	10
SQD7060-102	800	1020	17	3	125	10
SQD7060-132	910	1300	21	2.5	125	10
SQD9070-301	225	300	6	6	80	10
SQD9070-601	450	600	8	6	80	10
SQD9070-701	500	700	10	5	80	10
SQD9070-102	750	1000	13	4	80	10
SQD9070-272	2000	2700	88	2	80	10

## PHYSICAL CHARACTERISTICS: WINDING:

DIMENSIONS IN:mm

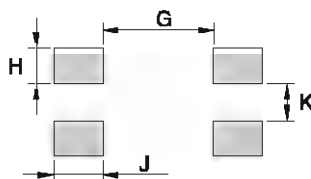
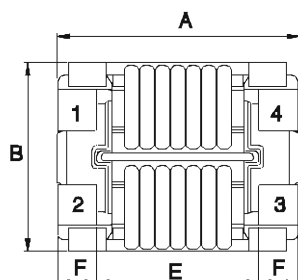
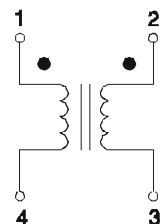
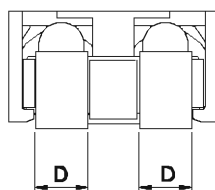
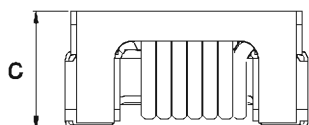

LAND PATTERNS

- Impedance test with HP4191A or HP4395A
- RDC:QuadTech 1880 Milliohmeter
- Insulation resistance: 10MΩ Min
- Operating temperature: -40°C to +125°C
- Storage Temperature: -40°C to +125°C
- Packing: 1500Pcs/Reel(SQD7060)  
800Pcs/Reel(SQD9070)

	A	B	C	D	E	F	G	H	J	K
SQD7060	7.0±0.2	6.0±0.2	3.8Max	1.5±0.5	4.0typ	1.5±0.5	4.0	1.5	2.5	1.5
SQD9070	9.0±0.2	7.0±0.2	4.6Max	1.5±0.5	6.0typ	1.5±0.5	6.0	1.5	2.5	2.0

# SURFACE-MOUNT COMMON MODE CHOKES

SQD7060-301

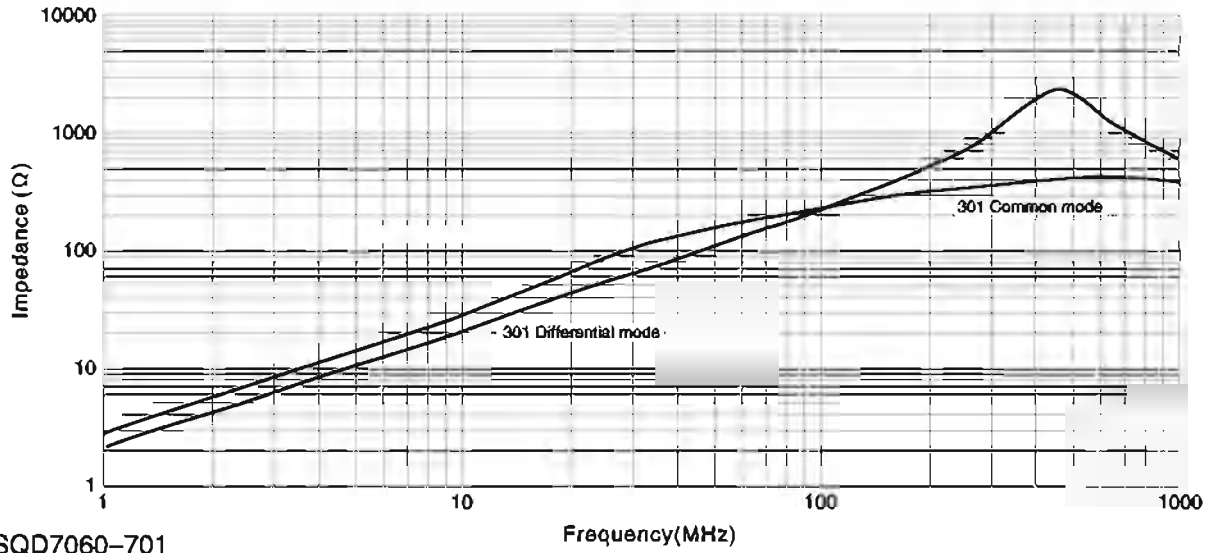

SQD7060-701

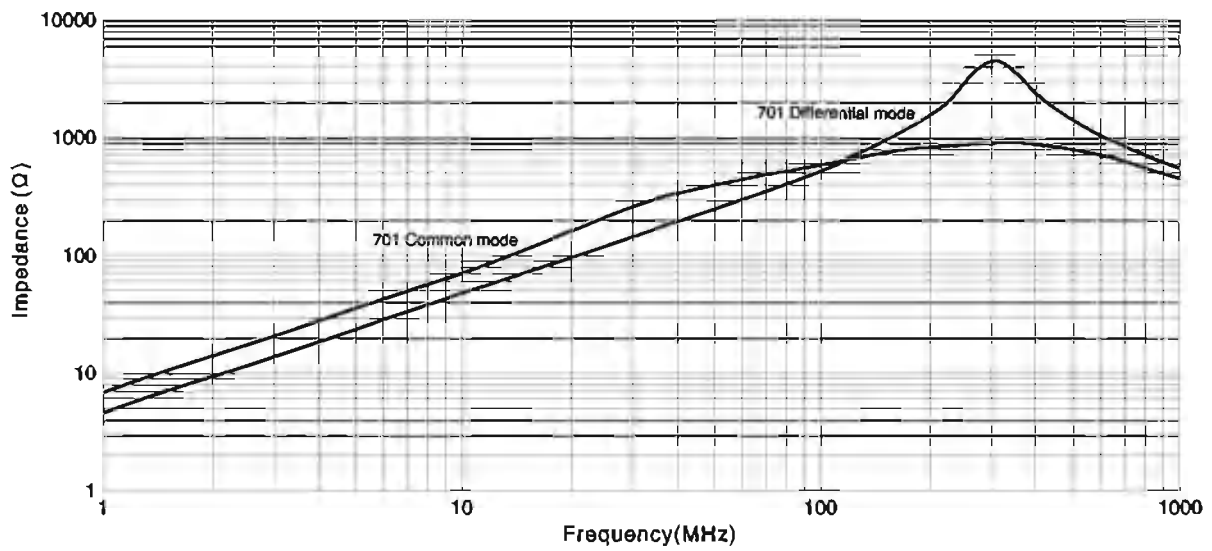

SQD9070-701

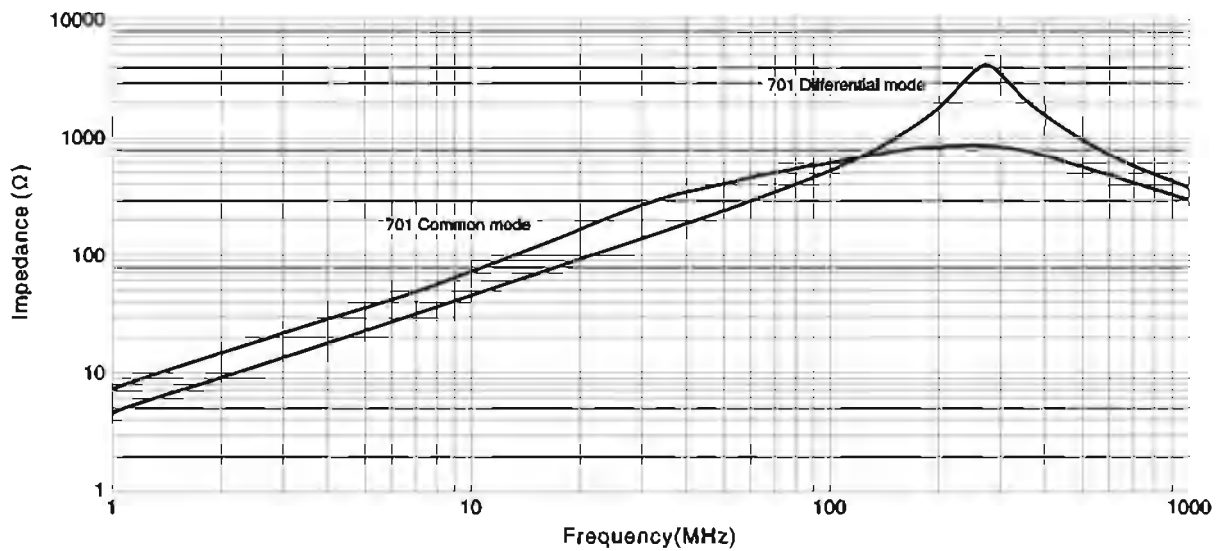

# SMD HIGH CURRENT FLAT WIRE COMMON MODE CHOKE SQS1212 SERIES

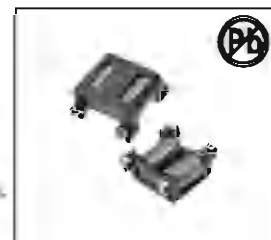

## FEATURES:

- Compact size, low DCR, low leakage due to square core.
- High permeability material, High Impedance at low frequency.
- High attenuation to noise, due to low stray capacitance.
- Flammability tested to UL 94 V-0.
- Low cost, high consistency with automated production.
- RoHS, REACH compliance, Halogen free available.

## APPLICATIONS:

- Solutions for use in a wide array of power supply circuits.
- High density switching mode power supply devices.
- Ideal for use in consumer electronics and industrial applications: LCD TV, Battery chargers, Power Adapter, Home appliances.
- Space saving for existing Common Mode Chokes.

## ELECTRICAL CHARACTERISTICS:

Part Number	Inductance (mH)Min	Common mode peak impedance (kΩ)	Leakage inductance (uH)Max	DCR (mΩ) Max	Rated current (A)Max
SQS1212-801Y	0.8	9.06@3.73MHz	80	25	3.6
SQS1212-102Y	1.0	14.12@2.9MHz	100	36	3.0
SQS1212-152Y	1.5	22.67@2.15MHz	115	52	2.5
SQS1212-252Y	2.5	31.51@2.48MHz	130	95	1.8
SQS1212-302Y	3.0	44.31@2.31MHz	130	115	1.5
SQS1212-362Y	3.6	47.1@1.96MHz	140	158	1.2
SQS1212-502Y	5.0	66.55@1.84MHz	150	216	1.0
SQS1212-682Y	6.8	81.25@1.32MHz	180	315	0.8
SQS1212-952Y	9.5	123.94@0.85MHz	210	500	0.6

## TECHNICAL INFORMATION & PHYSICAL CHARACTERISTICS:

### DIMENSIONS IN:mm

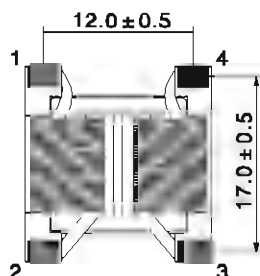
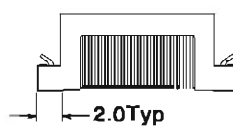
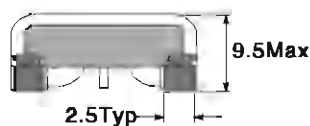
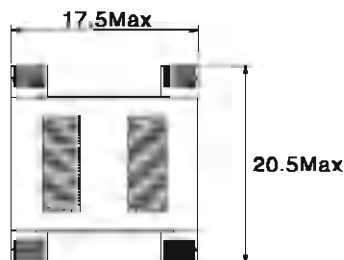

### LAND PATTERNS

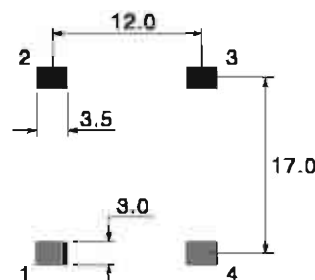

- Inductor Testing: HP4284A (Equivalent acceptable)
- DCR: QuadTech 1880 Milliohmmeter
- Rated voltage: 80VAC- 280VAC
- High withstanding voltage between windings: 2400VAC /60 sec.
- High Insulation resistance 100MΩ Min @ 500VDC between windings.
- Operating temperature: -40°C--+125°C (including coil temperature rise).
- Storage temperature: - 40°C- +85°C.
- Solder methods: Vapor Phase, Infrared Reflow
- Reelstence to soldering heat: 260°C for 10 seconds
- Solvent resistance: Conforms to MIL-STD-202E

**IMPEDANCE VS FREQUENCY:**

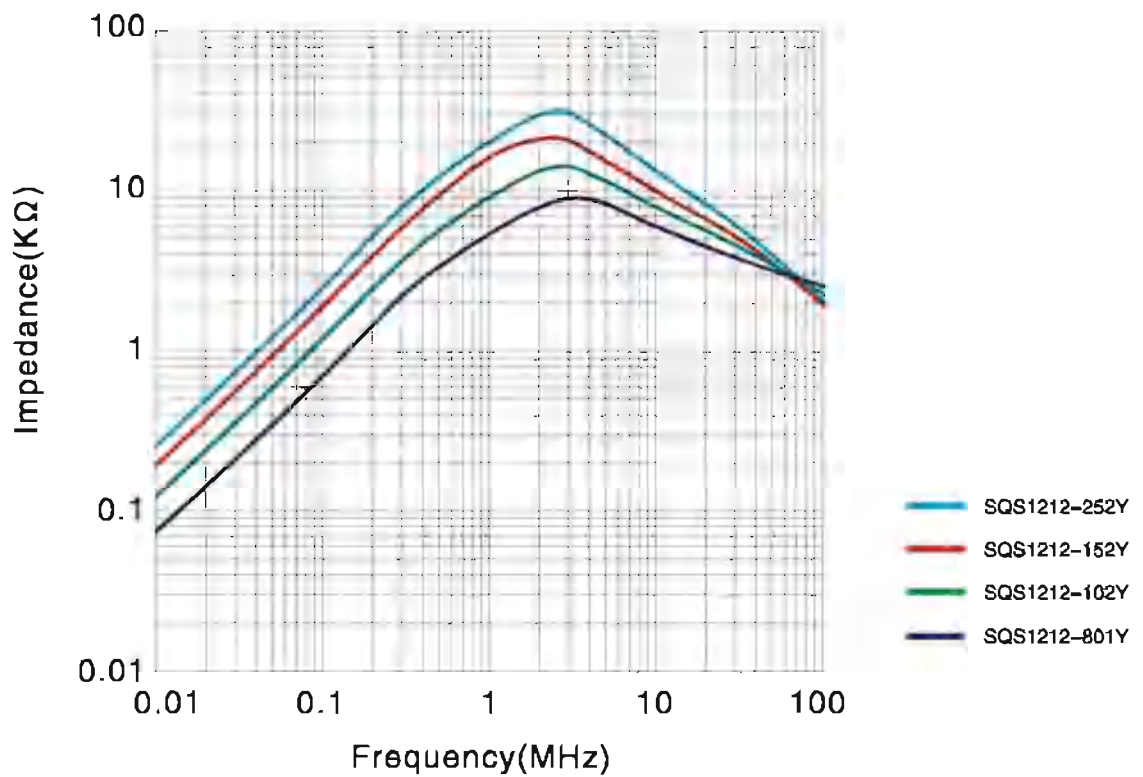
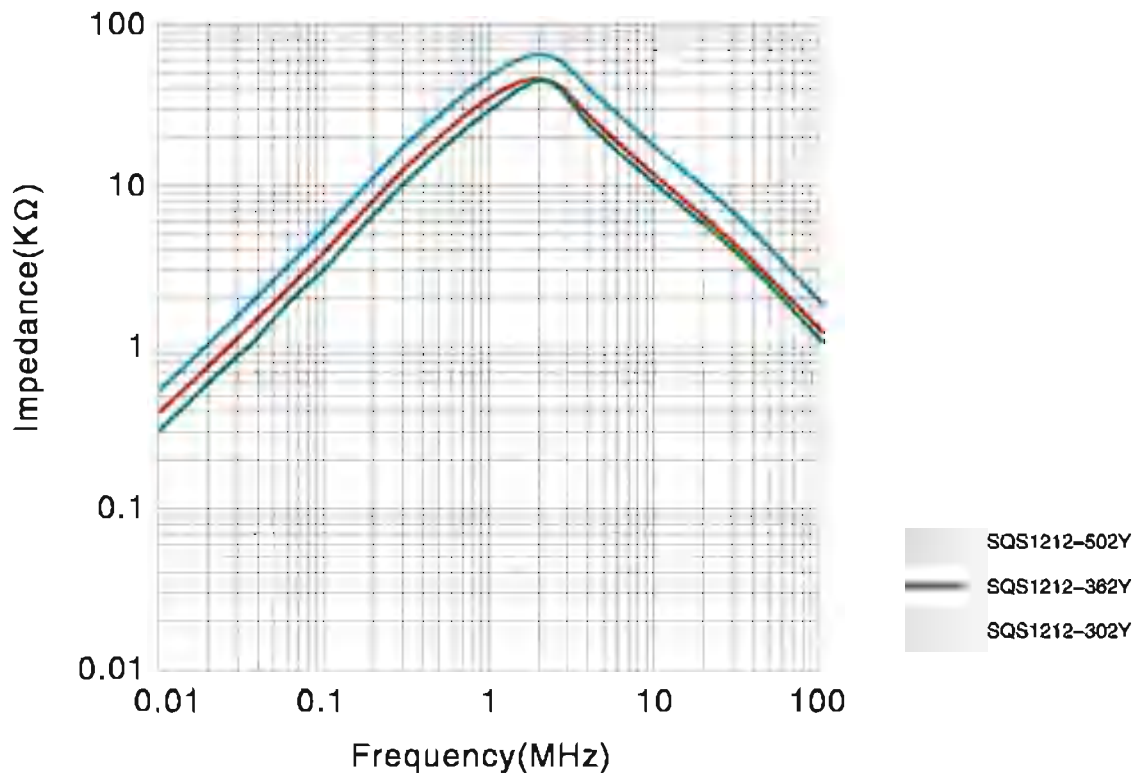

# SMD HIGH CURRENT FLAT WIRE COMMON MODE CHOKE SQS1212HP SERIES

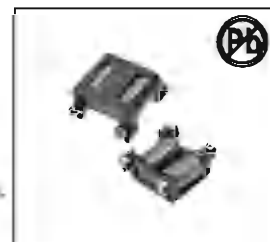

## FEATURES:

- Compact size, low DCR, low leakage due to square core.
- High permeability material, High Impedance at low frequency.
- High attenuation to noise, due to low stray capacitance.
- Flammability tested to UL 94 V-0.
- Low cost, high consistency with automated production.
- RoHS, REACH compliance, Halogen free available.

## APPLICATIONS:

- Solutions for use in a wide array of power supply circuits.
- High density switching mode power supply devices.
- Ideal for use in consumer electronics and industrial applications: LCD TV, Battery chargers, Power Adapter, Home appliances.
- Space saving for existing Common Mode Chokes.

## ELECTRICAL CHARACTERISTICS:

Part Number	Inductance (mH)Min	Common mode peak impedance (kΩ)	Leakage inductance (uH)Max	DCR (mΩ) Max	Rated current (A)Max
SQS1212HP-182Y	1.8	5.98@2.69MHz	120	25	3.6
SQS1212HP-252Y	2.5	7.37@2.56MHz	130	36	3.0
SQS1212HP-362Y	3.6	11.72@2.34MHz	140	52	2.5
SQS1212HP-582Y	5.8	17.69@2.23MHz	160	95	1.8
SQS1212HP-702Y	7.0	19.62@2.15MHz	200	115	1.5
SQS1212HP-862Y	8.5	26.22@2.01MHz	200	158	1.2
SQS1212HP-123Y	12.0	32.44@1.55MHz	230	216	1.0
SQS1212HP-153Y	15.0	39.25@1.15MHz	280	315	0.8
SQS1212HP-223Y	22.0	57.64@0.85MHz	360	500	0.6

## TECHNICAL INFORMATION & PHYSICAL CHARACTERISTICS:

### DIMENSIONS IN:mm

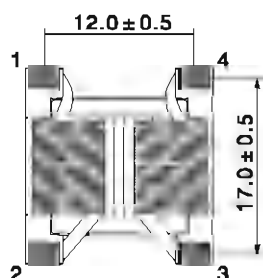
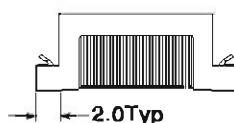
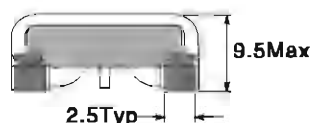
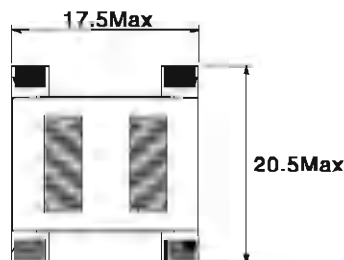

### LAND PATTERNS

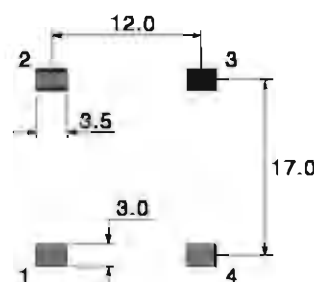

- Inductor Testing: HP4284A (Equivalent acceptable)
- DCR: QuadTech 1880 Milliohmmeter
- Rated voltage: 80VAC- 280VAC
- High withstanding voltage between windings: 2400VAC /60 sec.
- High Insulation resistance 100MΩ Min @ 500VDC between windings.
- Operating temperature: -40°C--+125°C (Including coil temperature rise).
- Storage temperature: - 40°C- +85°C.
- Solder methods: Vapor Phase, Infrared Reflow
- Reelstence to soldering heat: 260°C for 10 seconds
- Solvent resistance: Conforms to MIL-STD-202E

# IMPEDANCE VS FREQUENCY:

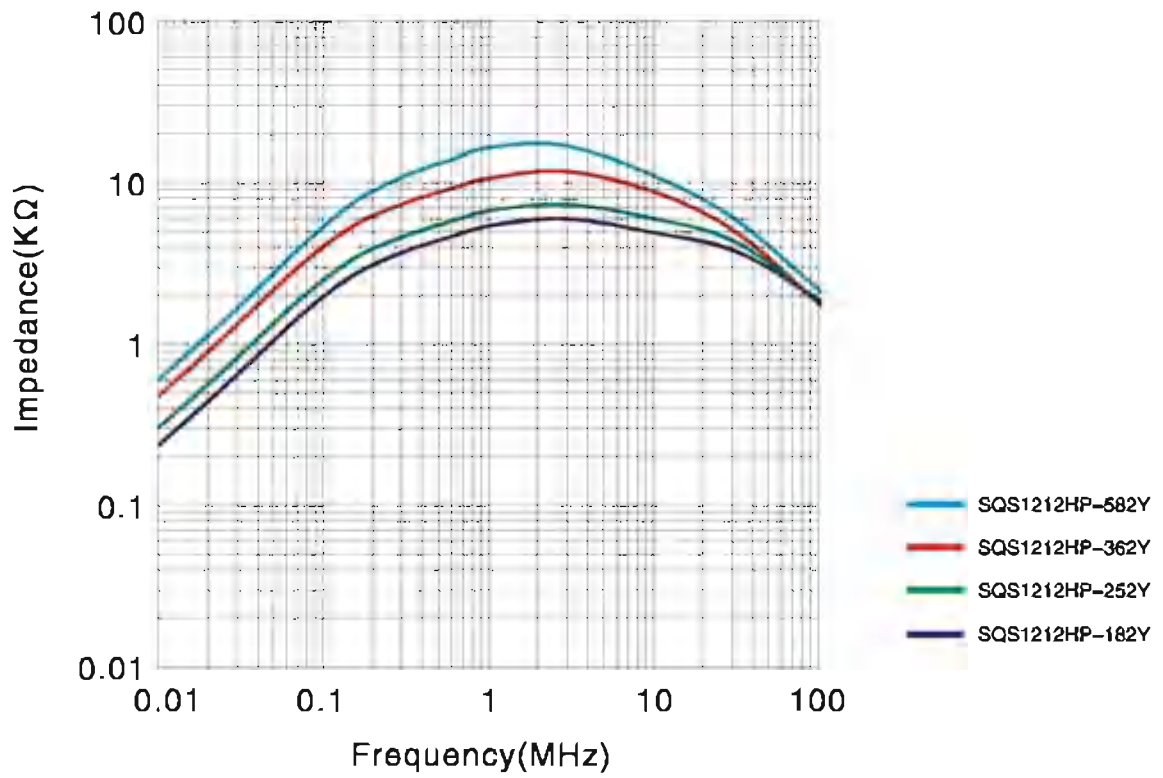
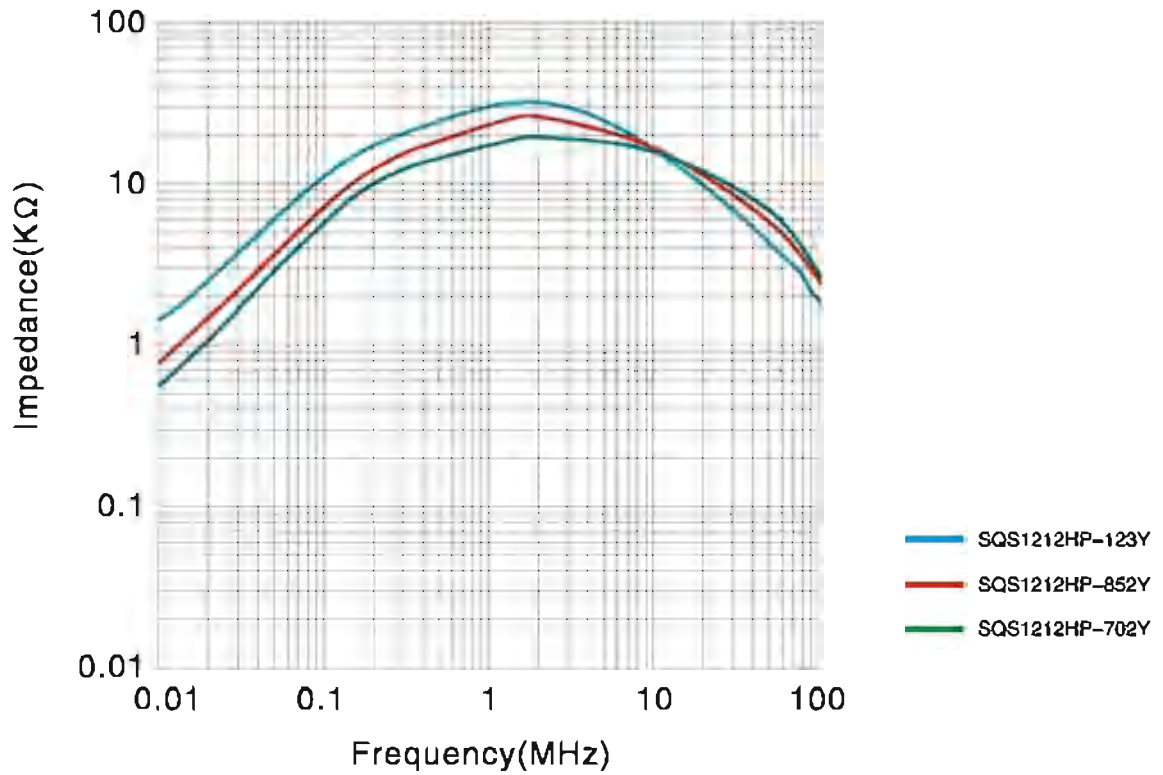

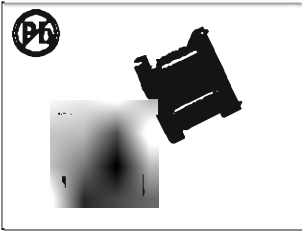

# SMD Flat Common Mode Chokes

## SQS1515A SERIES

### FEATURES:

- Compact size, low DCR, low leakage due to square core
- High permeability material, High Impedance at low frequency
- High attenuation to noise, due to low stray capacitance
- Flammability tested to UL94V-0
- High withstanding voltage between winding
- High Insulation resistance
- Low cost, high consistency with automated production
- RoHS, REACH compliance

### APPLICATION:

- Solutions for use in a wide array of power supply circuits
- High density switching mode power supply devices
- Ideal for use in consumer electronics and industrial applications: LCD TV, Battery chargers, Power Adapter, Home appliances
- Space saving for existing Common Mode Chokes

### ELECTRICAL CHARACTERISTICS:

Part Number	Inductance Min. (mH).	DCR Max. (mΩ).	Rated current (A)
SQS1515A-203-1.5A	20.0	250	1.5-2.0
SQS1515A-153-1.8A	15.0	200	1.8-2.2
SQS1515A-153-2.0A	15.0	180	2.0-2.8
SQS1515A-103-2.0A	10.0	150	2.0-2.5
SQS1515A-103-2.5A	10.0	80	2.5-3.0
SQS1515A-502-2.5A	5.0	80	2.5-3.5
SQS1515A-302-3.5A	3.0	70	3.5-4.5
SQS1515A-202-5.0A	2.0	60	5.0-5.0

### TECHNICAL INFORMATION & PHYSICAL CHARACTERISTICS:

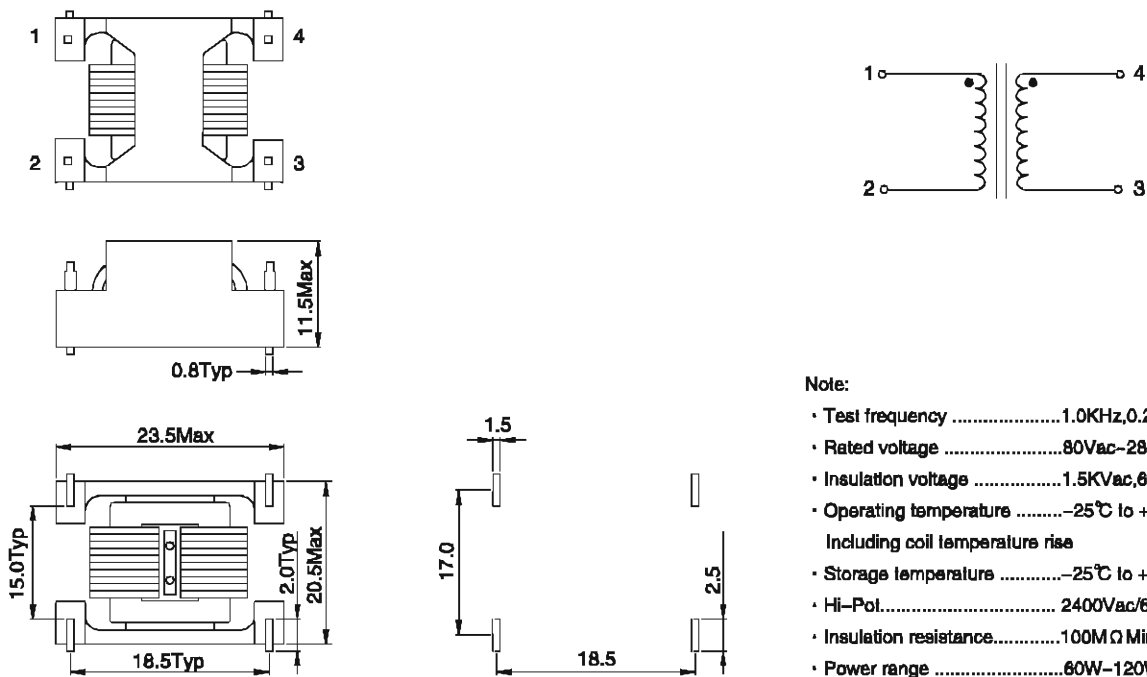

**Note:**

- Test frequency .....1.0KHz, 0.25V
- Rated voltage .....80Vac-280Vac
- Insulation voltage .....1.5KVac, 60Sec
- Operating temperature .....-25°C to +125°C  
Including coil temperature rise
- Storage temperature .....-25°C to +100°C
- Hi-Pot.....2400Vac/60Sec
- Insulation resistance.....100MΩ Min @ 500Vdc
- Power range .....60W-120W

LAND PATTERNS

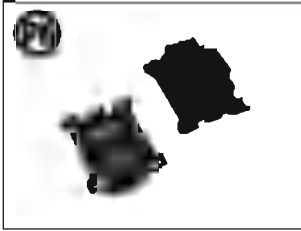

# SMD Flat Common Mode Chokes

## SQS1515B SERIES

### FEATURES:

- Compact size, low DCR, low leakage due to square core
- High permeability material, High impedance at low frequency
- High attenuation to noises, due to low stray capacitance
- Flammability tested to UL94V-0
- High withstanding voltage between winding
- High insulation resistance
- Low cost, high consistency with automated production
- RoHS, REACH compliance

### APPLICATION:

- Solutions for use in a wide array of power supply circuits
- High density switching mode power supply devices
- Ideal for use in consumer electronics and industrial applications: LCD TV, Battery chargers, Power Adapter, Home appliances
- Space saving for existing Common Mode Chokes

### ELECTRICAL CHARACTERISTICS:

Part Number	Inductance Min. (mH)	DCR Max. (mΩ)	Rated current (A)
SQS1515B-203-1.5A	20.0	250	1.5-2.0
SQS1515B-153-1.8A	15.0	200	1.8-2.2
SQS1515B-153-2.0A	15.0	180	2.0-2.8
SQS1515B-103-2.0A	10.0	150	2.0-2.5
SQS1515B-103-2.5A	10.0	80	2.5-3.0
SQS1515B-502-2.5A	5.0	80	2.5-3.5
SQS1515B-302-3.5A	3.0	70	3.5-4.5
SQS1515B-202-5.0A	2.0	80	5.0-5.0

### TECHNICAL INFORMATION & PHYSICAL CHARACTERISTICS:

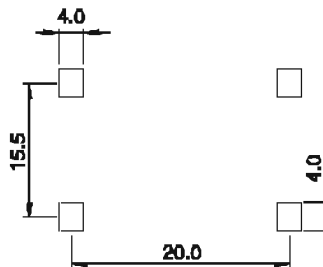
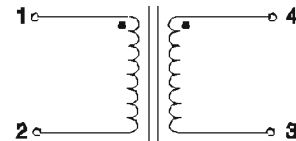
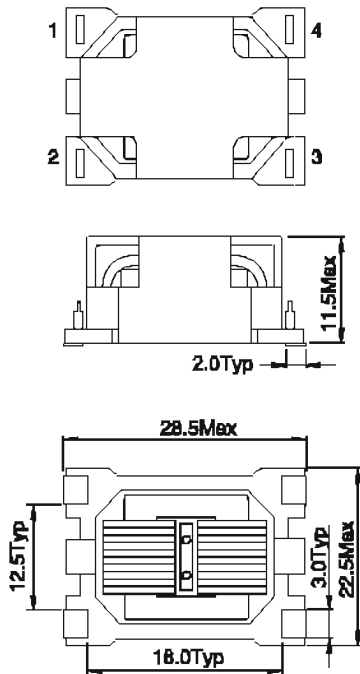

LAND PATTERNS

#### Notes:

- Test frequency .....1.0KHz, 0.25V
- Rated voltage .....80Vac-280Vac
- Insulation voltage .....1.5KVac, 60Sec
- Operating temperature .....-25°C to +125°C  
Including coil temperature rise
- Storage temperature .....-25°C to +100°C
- Hi-Pot.....2400Vac/60Sec
- Insulation resistance.....100MΩ Min @ 500Vdc
- Power range .....80W-120W

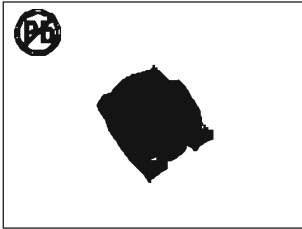

# SMD Flat Common Mode Chokes

## SQS1918 SERIES

### FEATURES:

- Compact size, low DCR, low leakage due to square core
- High permeability material, High Impedance at low frequency
- High attenuation to noise, due to low stray capacitance
- Flammability tested to UL94V-0
- High withstanding voltage between winding
- High insulation resistance
- Low cost, high consistency with automated production
- RoHS, REACH compliance

### APPLICATION:

- Solutions for use in a wide array of power supply circuits
- High density switching mode power supply devices
- Ideal for use in consumer electronics and industrial applications: LCD TV, Battery chargers, Power Adapter, Home appliances
- Space saving for existing Common Mode Chokes

### ELECTRICAL CHARACTERISTICS:

Part Number	Inductance Min. (mH).	DCR Max. (mΩ).	Rated current (A)
SQS1918-602-3.0A	6.0	100	3.0
SQS1918-123-2.0A	12.0	115	2.0
SQS1918-223-1.5A	22.0	150	1.5

### TECHNICAL INFORMATION & PHYSICAL CHARACTERISTICS:

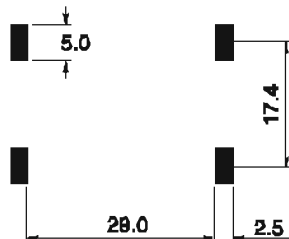
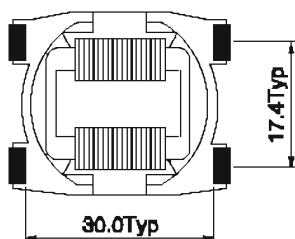
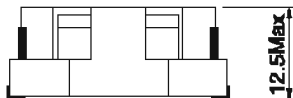
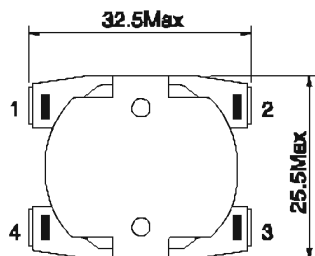

LAND PATTERNS

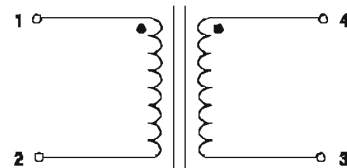

Note:

- Test frequency .....1.0KHz, 0.25V
- Rated voltage .....80Vac-280Vac
- Insulation voltage .....1.5KVac, 60Sec
- Operating temperature .....-25°C to +125°C  
Including coil temperature rise
- Storage temperature .....-25°C to +100°C
- HI-Pot.....2400Vac/60Sec
- Insulation resistance.....100M Ω Min @ 500Vdc

# SURFACE-MOUNT TOROIDAL COILS AND COMMON MODE TOROIDAL CHORES

## STC SERIES

### STC-01, 02, 03, 04

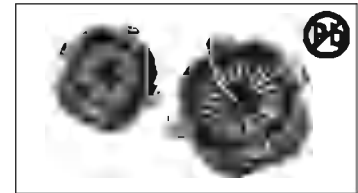

#### FEATURES:

- Higher Frequency
- High Saturation Material
- Low EMI Radiation
- Pick and Place
- Low DC Resaltance

#### OPTIONS:

- Tape and Reel is Standard
- Custom Design Available
- CMC Design Available
- Tolerance:20% is Standard
- Tighter Tolerances Available

#### COMMON APPLICATIONS:

- Electronic Appliances
- DC - DC Conversion (Paraller Mode)
- Isolation/Coupling(Transformer)
- Input Filter(Serial Mode)
- EMVRFI Suppression

### STANDARD SPECIFICATION:

Part Number STC-XX-	Parallel Ratings 01			Parallel Ratings 02			Parallel Ratings 03			Parallel Ratings 04		
	OCL nominal +/-25% ( $\mu$ H)	IDC A(max)	DCR $\Omega$ @20°C	OCL nominal +/-25% ( $\mu$ H)	IDC A(max)	DCR $\Omega$ @20°C	OCL nominal +/-25% ( $\mu$ H)	IDC A(max)	DCR $\Omega$ @20°C	OCL nominal +/-25% ( $\mu$ H)	IDC A(max)	DCR $\Omega$ @20°C
0.33	0.402	10.0	0.0032	0.284	10.9	0.0028	0.368	11.4	0.0027	0.313	12.2	0.0026
0.88	0.752	9.0	0.0039	0.875	9.4	0.0039	0.888	9.3	0.0041	0.744	10.8	0.0034
1.0	1.18	7.26	0.0060	1.26	8.22	0.0050	1.08	8.38	0.0051	1.39	8.23	0.0045
2.0	2.30	5.64	0.010	1.88	6.74	0.0077	2.11	7.26	0.0068	2.18	8.38	0.0054
5.0	4.70	4.27	0.017	5.06	4.34	0.018	5.20	5.24	0.018	4.28	7.21	0.0073
8.0	7.84	3.37	0.028	7.80	3.50	0.027	8.43	4.23	0.020	8.70	5.48	0.013
10.0	10.58	2.84	0.039	11.38	2.89	0.040	9.68	3.64	0.027	10.58	4.87	0.017
15.0	15.23	2.07	0.075	15.48	2.89	0.046	15.52	3.25	0.033	14.70	3.87	0.025
20.0	20.73	1.71	0.109	20.22	2.24	0.067	20.81	2.43	0.061	18.58	3.62	0.028
25.0	24.86	1.46	0.148	25.60	1.89	0.085	24.77	2.34	0.065	25.14	3.02	0.041
33.0	34.26	1.22	0.213	34.84	1.56	0.138	33.71	1.93	0.098	34.80	2.49	0.061
50.0	51.18	0.88	0.327	49.38	1.28	0.206	48.71	1.56	0.147	50.11	2.05	0.088
88.0	87.87	0.92	0.375	88.44	1.07	0.283	88.80	1.28	0.217	88.21	1.70	0.181
100.0	99.46	0.74	0.588	102.38	0.75	0.588	99.07	1.05	0.325	100.67	1.37	0.201
150.0	147.4	0.87	0.713	152.9	0.68	0.722	148.7	0.85	0.488	153.5	1.10	0.318
200.0	198.8	0.82	0.825	197.5	0.84	0.814	198.8	0.71	0.711	200.4	0.92	0.447
300.0	300.8	0.56	1.012	303.7	0.56	1.008	298.2	0.56	1.122	302.8	0.75	0.875

### PHYSICAL CHARACTERISTICS

### DIMENSIONS:INCHES

#### CONNECTION DIAGRAMS

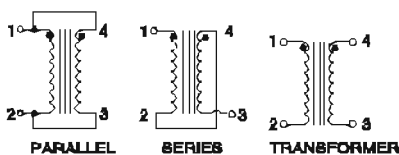

Case Size	A	B	C	D	E	F	G
STC-01	.350	.450	.185	.277	.422	.382	.145
STC-02	.350	.450	.235	.277	.422	.382	.145
STC-03	.450	.550	.190	.348	.492	.482	.180
STC-04	.450	.550	.250	.348	.492	.482	.180

Dimensions in inches, typical

#### MECHANICAL DIAGRAM

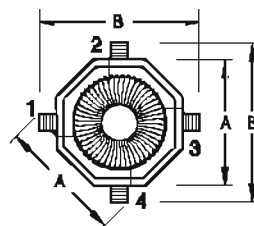
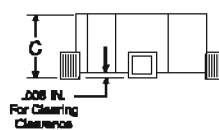

BOTTOM VIEW

#### RECOMENDED LAYOUT

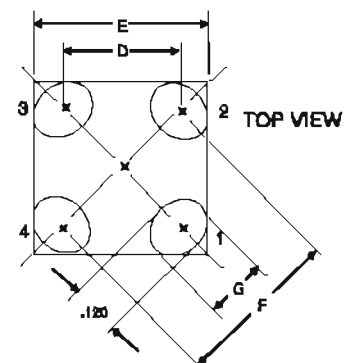

### TECHNICAL INFORMATION:

Inductance measure at 100KHz 0.1VPrms.  
 Insulation Resistance: 100Vdc 1KM $\Omega$  min.  
 Turns Ratio: 1.1  $\pm$  0%  
 RDC:CluedTech 1880 Milliohm-meter  
 Soldering temperature:260°C for 4  $\pm$  1 seconds  
 Operating temperature:-40°C to +125°C  
 Storage Temperature: -55°C to +125°C  
 Different package available per special request  
 Max of 35% saturation on DC bias applied

Notes:All specifications subject to change without notice.

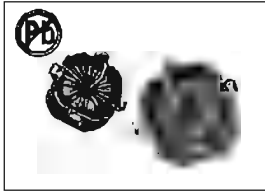

# COMMON MODE CHOKES STC01F SERIES

## FEATURES:

- Inductance range from 4.5uH to 205uH
- Current range up to 7.0 Amps
- Noise attenuation up to 44 dB
- Frequency range up to 100 MHz
- Meets UL94V-0 flammability standard
- Ferrite core material

## OPTIONS:

- Supplied In tape and reel packaging

## COMMON APPLICATIONS:

- EMI filters
- DC-DC brick power supplies
- Discrete output supplies
- Discrete and point-of-use power supplies

## ELECTRICAL CHARACTERISTICS:

Part Number	L(0A) (uH) Min 100KHz,0.1V	I <sub>ma</sub> (A)Max	DCR (Ω)Typ (1-2)	DCR (Ω)Typ (4-3)	L <sub>k</sub> (uH) Typ 100KHz,0.1V	Interwinding Capacitance (pF)
STC01F-4R5Y	4.5	7.00	0.0027	0.0027	0.05	2.0
STC01F-8R0Y	8	5.70	0.0040	0.0040	0.09	2.1
STC01F-120Y	12.6	4.10	0.0077	0.0077	0.14	2.2
STC01F-180Y	18	3.80	0.0089	0.0089	0.20	2.3
STC01F-250Y	25	3.60	0.0100	0.0100	0.28	2.4
STC01F-320Y	32.8	3.10	0.0138	0.0138	0.36	2.5
STC01F-410Y	41.5	2.80	0.019	0.019	0.45	2.6
STC01F-510Y	51.2	2.20	0.026	0.026	0.56	2.7
STC01F-620Y	62	1.90	0.035	0.035	0.68	2.7
STC01F-730Y	73.7	1.65	0.048	0.048	0.81	2.8
STC01F-101Y	100	1.35	0.070	0.070	1.10	2.9
STC01F-131Y	131	1.15	0.100	0.100	1.45	3.0
STC01F-161Y	166	1.00	0.138	0.138	1.83	3.1
STC01F-201Y	205	0.85	0.186	0.186	2.25	3.2

## PHYSICAL CHARACTERISTICS

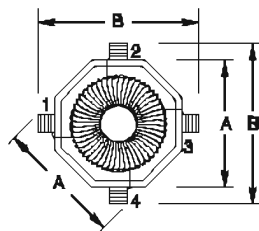
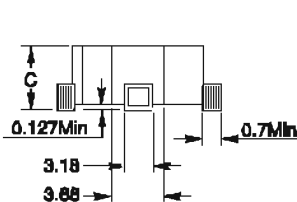

BOTTOM VIEW

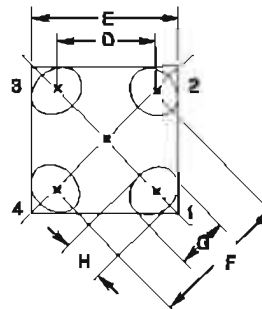

Recommended layout

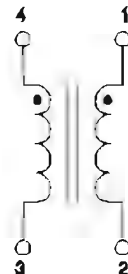

### NOTES:

- Inductance measure at 100KHz 0.1Vrms.
- Insulation Resistance: 100Vdc 1KMO min.
- Dielectric Strength: 500 Vrms between windings
- Turns Ratio: 1:1
- RDC: QuadTech 1880 Milliohmmeter
- Soldering temperature: 260°C for 4 ± 1 seconds
- Operating temperature: -40°C to +125°C
- Storage Temperature: -40°C to +125°C
- Different package available per special request
- Max of 35% saturation on DC bias applied

A	B	C	D	E	F	G	H
8.89	11.43	4.2Max	7.04	10.72	9.98	3.68	3.05

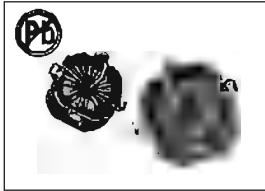

## COMMON MODE CHOKES STC02F SERIES

### FEATURES:

- Inductance range from 25uH to 1340uH
- Current range up to 5.35 Amps
- Noise attenuation up to 44 dB
- Frequency range up to 100 MHz
- Meets UL94V-0 flammability standard
- Ferrite core material

### OPTIONS:

- Supplied In tape and reel packaging

### COMMON APPLICATIONS:

- EMI filters
- DC-DC brick power supplies
- Discrete output supplies
- Discrete and point-of-use power supplies

### ELECTRICAL CHARACTERISTICS:

Part Number	L(0A) (uH) Min 100KHz,0.1V	I <sub>rms</sub> (A)Max	DCR (Ω)Typ (1-2)	DCR (Ω)Typ (4-3)	L <sub>k</sub> (uH) Typ 100KHz,0.1V	Interwinding Capacitance (pF)
STC02F-250Y	25	5.35	0.005	0.005	0.22	2.0
STC02F-400Y	40	4.40	0.008	0.008	0.34	2.3
STC02F-570Y	57	3.80	0.012	0.012	0.47	2.5
STC02F-101Y	102	2.80	0.019	0.019	0.80	2.8
STC02F-161Y	160	2.30	0.029	0.029	1.25	3.1
STC02F-231Y	230	1.85	0.044	0.044	1.75	3.4
STC02F-271Y	270	1.80	0.060	0.060	2.00	3.6
STC02F-361Y	360	1.35	0.084	0.084	2.60	3.9
STC02F-461Y	460	1.10	0.120	0.120	3.30	4.1
STC02F-571Y	575	0.84	0.170	0.170	4.00	4.3
STC02F-701Y	700	0.80	0.230	0.230	5.00	4.6
STC02F-911Y	915	0.87	0.330	0.330	6.30	4.9
STC02F-102Y	1070	0.58	0.440	0.440	7.30	5.1
STC02F-132Y	1340	0.50	0.620	0.620	8.00	5.4

### PHYSICAL CHARACTERISTICS

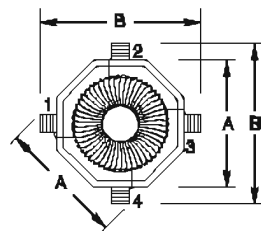
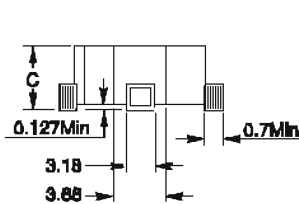

BOTTOM VIEW

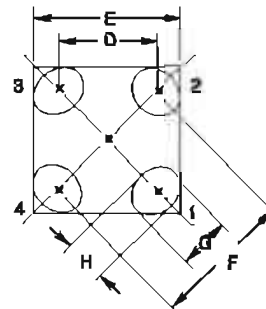

Recommended layout



#### NOTES:

- Inductance measure at 100KHz 0.1Vrms.
- Insulation Resistance: 100Vdc 1KΩ min.
- Dielectric Strength: 500 Vrms between windings
- Turns Ratio: 1:1
- RDC: QuadTech 1880 Milliohmmeter
- Soldering temperature: 260°C for 4±1 seconds
- Operating temperature: -40°C to +125°C
- Storage Temperature: -40°C to +125°C
- Different package available per special request
- Max of 35% saturation on DC bias applied

A	B	C	D	E	F	G	H
8.89	11.43	8.0Max	7.04	10.72	9.98	3.68	3.05

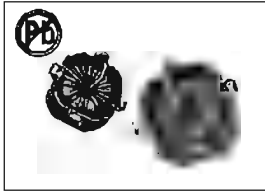

# COMMON MODE CHOKES STC04F SERIES

## FEATURES:

- Inductance range from 28uH to 1310uH
- Current range up to 5.7 Amps
- Noise attenuation up to 44 dB
- Frequency range up to 100 MHz
- Meets UL94V-0 flammability standard
- Ferrite core material

## OPTIONS:

- Supplied In tape and reel packaging

## COMMON APPLICATIONS:

- EMI filters
- DC-DC brick power supplies
- Discrete output supplies
- Discrete and point-of-use power supplies

## ELECTRICAL CHARACTERISTICS:

Part Number	L(0A) (uH) Min 100KHz,0.1V	I <sub>rms</sub> (A)Max	DCR (Ω)Typ (1-2)	DCR (Ω)Typ (4-3)	L <sub>k</sub> (uH) Typ 100KHz,0.1V	Interwinding Capacitance (pF)
STC04F-280Y	28	5.70	0.005	0.005	0.31	2.80
STC04F-450Y	45	5.10	0.006	0.006	0.46	3.05
STC04F-640Y	64	4.75	0.007	0.007	0.64	3.30
STC04F-881Y	88	3.95	0.010	0.010	0.85	3.50
STC04F-141Y	146	3.10	0.017	0.017	1.30	3.70
STC04F-211Y	217	2.85	0.020	0.020	1.90	3.90
STC04F-251Y	258	2.45	0.027	0.027	2.20	4.15
STC04F-351Y	350	2.00	0.040	0.040	3.00	4.40
STC04F-401Y	400	1.70	0.053	0.053	3.30	4.65
STC04F-511Y	516	1.45	0.078	0.078	4.20	4.85
STC04F-641Y	648	1.20	0.107	0.107	5.10	5.10
STC04F-791Y	790	1.05	0.145	0.145	6.10	5.35
STC04F-102Y	1030	0.88	0.210	0.210	7.80	5.55
STC04F-132Y	1310	0.75	0.300	0.300	8.60	5.80

## PHYSICAL CHARACTERISTICS

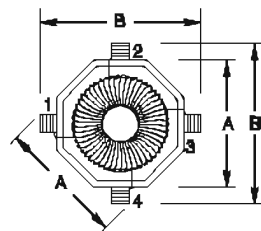
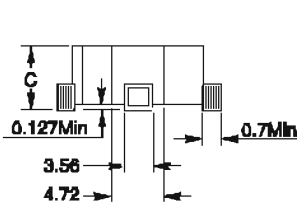

BOTTOM VIEW

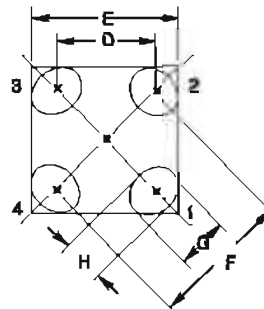

Recommended layout

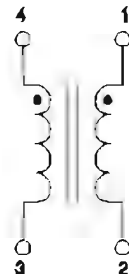

### NOTES:

- Inductance measure at 100KHz 0.1Vrms.
- Insulation Resistance: 100Vdc 1KΩ min.
- Dielectric Strength: 500 Vrms between windings
- Turns Ratio: 1:1
- RDC:QuadTech 1880 Milliohmmeter
- Soldering temperature:260°C for 4±1 seconds
- Operating temperature:-40°C to +125°C
- Storage Temperature:-40°C to +125°C
- Different package available per special request
- Max of 35% saturation on DC bias applied

A	B	C	D	E	F	G	H
11.43	13.97	6.35Max	8.84	12.5	12.5	4.08	3.05

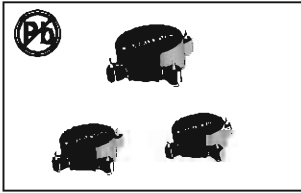

# SURFACE-MOUNT TOROIDAL CHOKES

## STC-05,06P SERIES

### FEATURES:

- Higher Frequency
- High Saturation Material
- Low EMI Radiation
- Pick and PLace
- Low DC Resistance

### OPTIONS:

- Packaging:Tape & Reel is standard (Qty:2000pcs)
- Bulk packaging available for smaller quantities
- Tolerance:10% and 5% is standard, tighter tolerances available

### COMMON APPLICATIONS:

- Electronic Appliances
- DC - DC Conversion (Paraller Mode)
- Isolation/Coupling(Transformer)
- Input Filter(Serial Mode)
- EMI/RFI Suppression

## ELECTRICAL CHARACTERISTICS:

POWDERED IRON CORE				MPP ALLOY CORE			
Part Number	L (μH)	DCR (Ω) Max	IDC (A) Max	Part Number	L (μH)	DCR (Ω) Max	IDC (A) Max
STC-05-R47M	0.47	0.005	7.90	STC-06P-R47M	0.47	0.004	7.90
STC-05-R68M	0.68	0.006	7.20	STC-06P-R68M	0.68	0.005	7.00
STC-05-1R0M	1.00	0.009	5.80	STC-06P-1R0M	1.00	0.006	6.50
STC-05-2R0M	2.00	0.014	4.60	STC-06P-2R0M	2.00	0.007	5.90
STC-05-5R0M	5.00	0.027	3.30	STC-06P-5R0M	5.00	0.014	4.40
STC-05-8R0M	8.00	0.033	3.00	STC-06P-8R0M	8.00	0.019	3.50
STC-05-100M	10.0	0.047	2.50	STC-06P-100M	10.0	0.020	3.40
STC-05-150M	15.0	0.057	2.30	STC-06P-150M	15.0	0.024	3.00
STC-05-200M	20.0	0.085	1.90	STC-06P-200M	20.0	0.055	2.10
STC-05-250M	25.0	0.116	1.80	STC-06P-250M	25.0	0.064	2.00
STC-05-330M	33.0	0.166	1.30	STC-06P-330M	33.0	0.072	1.80
STC-05-500M	50.0	0.202	1.20	STC-06P-500M	50.0	0.111	1.50
STC-05-680M	68.0	0.238	1.10	STC-06P-680M	68.0	0.158	1.20
STC-05-101M	100	0.585	0.72	STC-06P-101M	100	0.303	0.92
STC-05-151M	150	0.696	0.64	STC-06P-151M	150	0.372	0.82
STC-05-201M	200	0.810	0.60	STC-06P-201M	200	0.545	0.64
STC-05-301M	300	1.003	0.54	STC-06P-301M	300	0.872	0.82

Note:1. K= ± 10%,M= ± 20%,N= ± 30%

## TECHNICAL INFORMATION: PHYSICAL CHARACTERISTICS:

- Testing: (Equivalent acceptable)
- Inductance:Reduced by 10% to 20% @ IDC
- RDC:QuadTech 1880 Milliohm-meter
- IDC Max:Lowers Inductance by 10-20%
- Temperature range: -55°C to +125°C

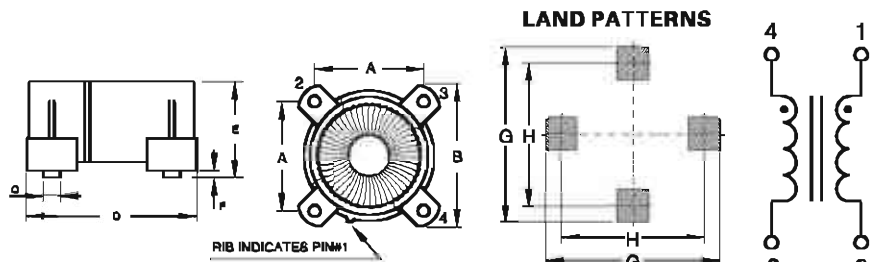

DIMENSIONS IN:mm

Part number	A	B	C	D	E	F	G	H
STC05	7.00 ± 0.25	9.14 ± 0.25	1.52 ± 0.25	8.90 ± 0.25	5.08 ± 0.25	1.02Max	12.7	10.3
STC06P	10.2 ± 0.25	13.5 ± 0.25	3.20 ± 0.25	12.4 ± 0.25	7.87Max	1.02Max	17.4	14.35

Note:All specifications subject to change without notice.

# COMMON MODE POWER LINE CHOKE

## STC05A SERIES

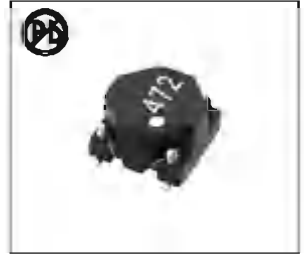

### FEATURES:

- Common mode chokes for telecom applications
- High impedance to minimize common mode noise
- Excellent EMI performance
- Meets UL94V-0 flammability standard

### APPLICATIONS:

- EMI filters
- DC-DC brick power supplies
- Discrete output supplies
- Discrete and point-of-use power supplies

## ELECTRICAL CHARACTERISTICS:

Part Number	L(0A) (uH) +50%/-30% 10KHz,0.1V	DCR (mΩ)Max	IDC (A)Max	Hi-Pot (Vdc) 50Hz,1mA,1S
STC05A-102Y	1000	180	0.95	500
STC05A-222Y	2200	300	0.75	500
STC05A-332Y	3300	360	0.52	500
STC05A-392Y	3900	540	0.52	500
STC05A-472Y	4700	900	0.35	500

## PHYSICAL CHARACTERISTICS

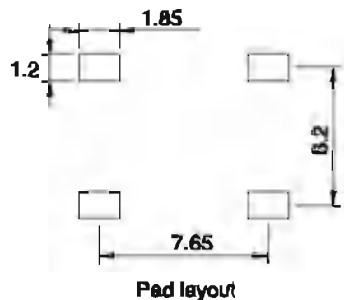
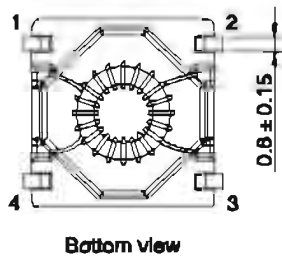
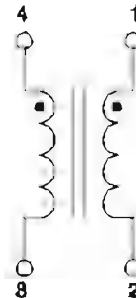
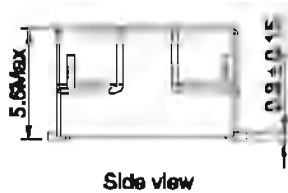
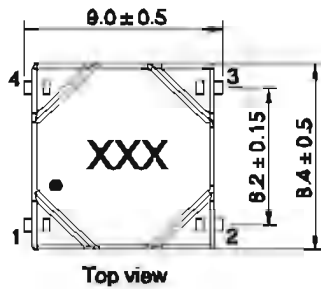

### NOTES:

- Temperature Rise .....40°C typical at IDC
- Operating Temperature .....-40°C to +125°C(Including self temperature rise)
- Storage Temperature .....-40°C to +125°C
- Soldering .....245°C, 5 seconds max
- Dielectric Strength .....500 Vrms between windings

## IMPEDANCE COMMON MODE

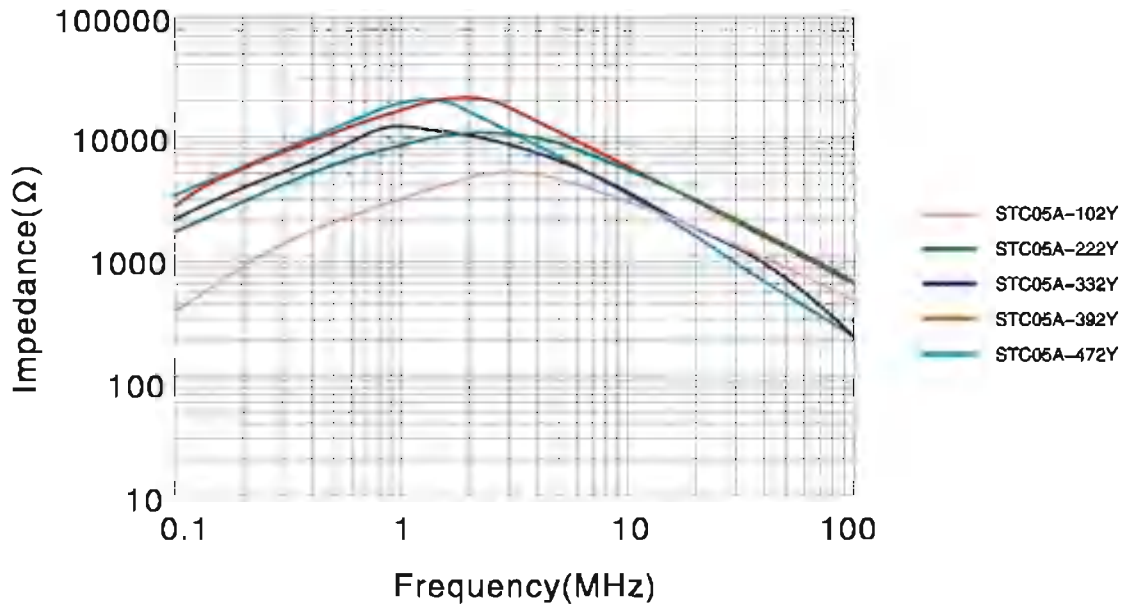

## IMPEDANCE DIFFERENTIAL MODE

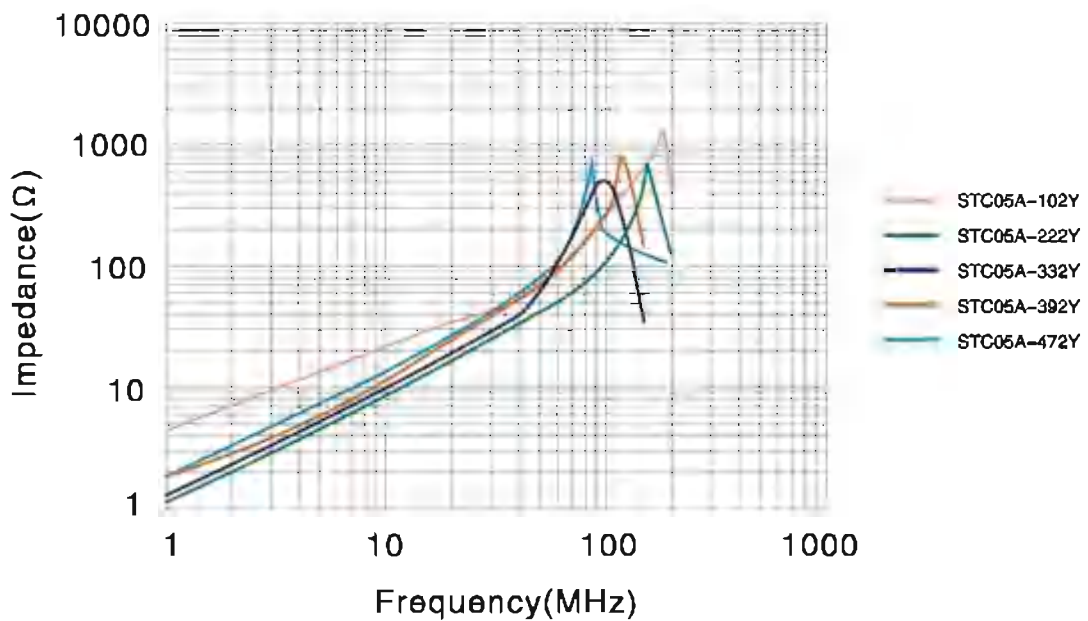

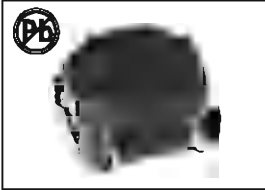

# COMMON MODE CHOKES

## STC05F SERIES

### FEATURES:

- Inductance range from 25uH to 1600uH
- Current range up to 5.35 Amps
- Noise attenuation up to 5.4 dB
- Meets UL84V-0 flammability standard
- Ferrite core material

### OPTIONS:

- Supplied in tape and reel packaging

### COMMON APPLICATIONS:

- EMI filters
- DC-DC brick power supplies
- Discrete output supplies
- Discrete and point-of-use power supplies

### ELECTRICAL CHARACTERISTICS:

Part Number	L(0A) (uH) ± 30% 100KHz,0.1V	I <sub>rms</sub> (A)Max	DCR (mΩ)Typ (1-2)	DCR (mΩ)Typ (4-3)	Lk (uH) Typ 100KHz,0.1V	Interwinding Capacitance (pF)
STC05F-250Y	25.0	5.35	3.10	3.10	0.22	2.00
STC05F-400Y	40.0	4.40	3.89	3.89	0.34	2.30
STC05F-700Y	70.0	3.60	5.35	5.35	0.47	2.50
STC05F-950Y	95.0	2.80	7.97	7.97	0.80	2.80
STC05F-151Y	150.0	2.30	16.85	16.85	1.25	3.10
STC05F-271Y	275.0	1.85	34.53	34.53	1.75	3.40
STC05F-321Y	320.0	1.60	39.72	39.72	2.00	3.60
STC05F-401Y	400.0	1.35	42.73	42.73	2.60	3.90
STC05F-501Y	500.0	1.10	57.43	57.43	3.30	4.10
STC05F-621Y	620.0	0.94	73.72	73.72	4.00	4.30
STC05F-751Y	750.0	0.80	98.34	98.34	5.00	4.60
STC05F-112Y	1100.0	0.67	161.2	161.2	6.30	4.90
STC05F-132Y	1300.0	0.58	245.5	245.5	7.30	5.10
STC05F-162Y	1600.0	0.50	350.5	350.5	9.00	5.40

### PHYSICAL CHARACTERISTICS

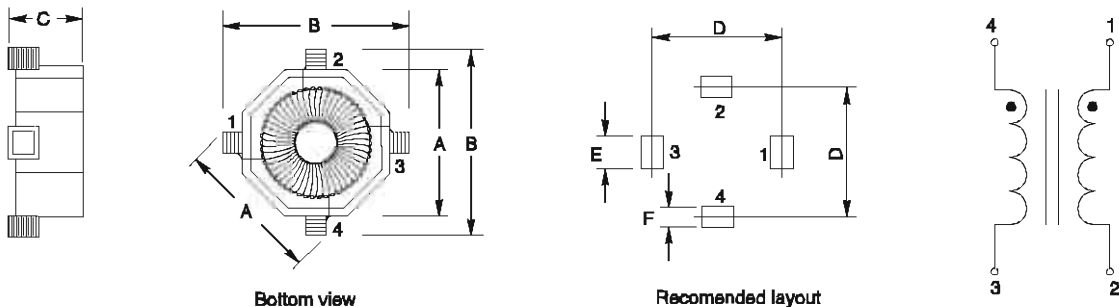

#### NOTES:

- Inductance measure at 100KHz 0.1VRms.
- Insulation Resistance: 100Vdc 1KMΩ min.
- Dielectric Strength: 500 Vrms between windings
- Turns Ratio: 1:1
- RDC:QuadTech 1880 Milliohm-meter
- Soldering temperature:260°C for 4±1 seconds
- Operating temperature:-40°C to +125°C
- Storage Temperature: -40°C to +125°C

A	B	C	D	E	F
8.8	11.8Max	5.2Max	9.9	3.5	3.0



# COMMON MODE CHOKES STC06 SERIES

## FEATURES:

- Inductance range from 0.075mH to 12mH
- Current range up to 9.8 Ampe
- High resonant frequency
- Meets UL94V-0 flammability standard
- Ferrite core material

## OPTIONS:

- Packaging:Tape & Reel is standard
- Bulk packaging available for smaller quantities

## COMMON APPLICATIONS:

- EMI filters
- DC-DC brick power supplies
- Discrete output supplies
- Discrete and point-of-use power supplies

## ELECTRICAL CHARACTERISTICS:

Part Number	L(0A) (mH) ± 25% 10KHz,0.1V	Leakage Inductance (uH)Max	DCR (Ω)Max	I <sub>rms</sub> (A) ΔT=20℃	I <sub>rms</sub> (A) ΔT=40℃
STC06-101Y	0.1	0.8	0.006	6.95	9.80
STC06-151Y	0.15	1.1	0.010	5.75	8.20
STC06-221Y	0.22	1.5	0.012	4.50	6.80
STC06-331Y	0.33	2.1	0.017	4.25	6.40
STC06-501Y	0.5	2.6	0.024	3.70	5.30
STC06-751Y	0.75	3.8	0.035	3.00	4.40
STC06-102Y	1.0	4.6	0.049	2.70	4.05
STC06-122Y	1.2	5.5	0.068	2.25	3.45
STC06-182Y	1.8	8.0	0.106	1.70	2.50
STC06-222Y	2.2	10.5	0.150	1.45	2.25
STC06-332Y	3.3	17.0	0.210	1.10	2.00
STC06-502Y	5.0	27.0	0.320	0.90	1.35
STC06-752Y	7.5	42.0	0.640	0.80	1.10
STC06-103Y	10.0	55.0	0.900	0.70	0.95
STC06-123Y	12.0	70.0	1.700	0.50	0.65

## PHYSICAL CHARACTERISTICS

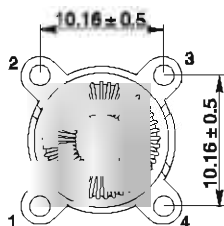
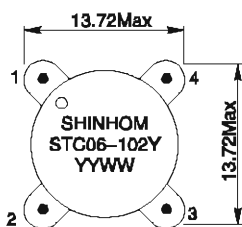

Bottom view

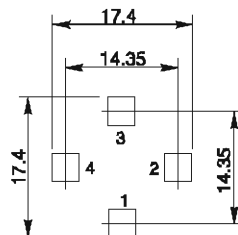
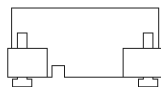

Recommended layout

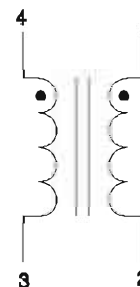

## NOTES:

1. Inductance tested at 10KHz,0.1V
2. DCR Measured at 25℃
3. Rated voltage: 1500V for 2Seconds between windings
4. I<sub>rms</sub> current: Current applied to one winding resulting in A Temperature rise of 20℃ or 40℃ at an ambient temperature of 25℃
5. Electrical specifications measured at 25℃
6. Operating temperature: -40℃ to +105℃
7. Storage temperature: -55℃ to +130℃

# COMMON MODE POWER LINE CHOKE

## STC06A SERIES

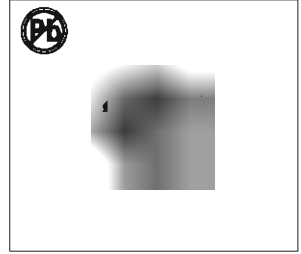

### FEATURES:

- Common mode chokes for AC power lines
- High impedance to minimize common mode noise
- Excellent EMI performance
- Meets UL94V-0 flammability standard

### APPLICATIONS:

- EMI filters
- DC-DC brick power supplies
- Discrete output supplies
- Discrete and point-of-use power supplies

## ELECTRICAL CHARACTERISTICS:

Part Number	L(0A) (uH) ± 35% 100KHz,0.1V	DCR (mΩ)Max	IDC (A)Max	Hi-Pot (Vdc) 50Hz,1mA,1S
STC06A-881Y	880	110	1.63	1000
STC06A-112Y	1170	200	1.22	1000
STC06A-302Y	3000	280	0.85	1000
STC06A-392Y	3900	350	0.85	1000
STC06A-682Y	6800	700	0.3	1000

## PHYSICAL CHARACTERISTICS

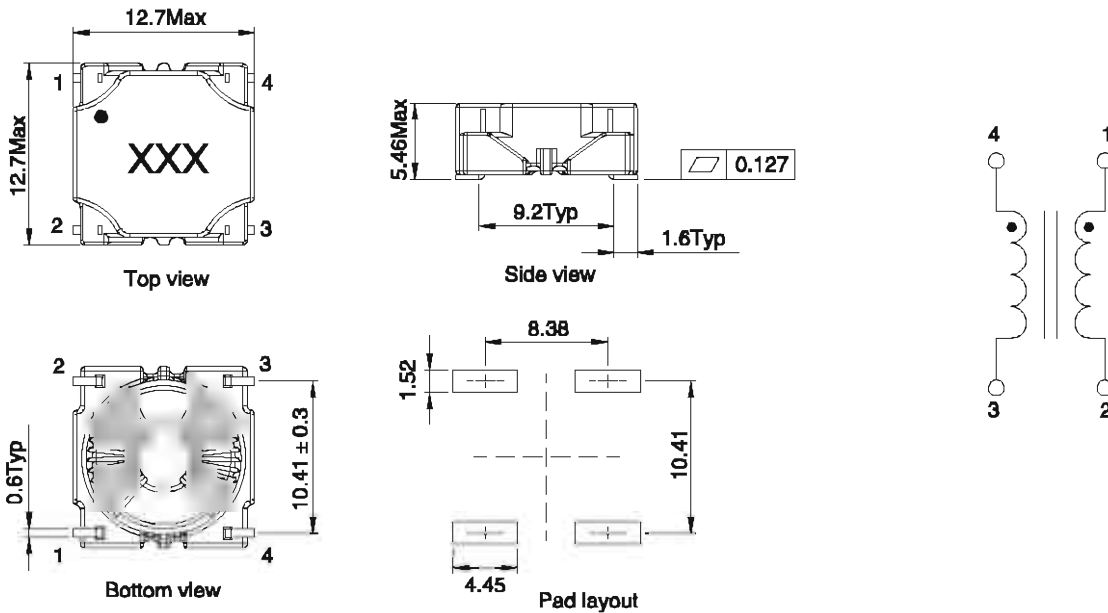

### NOTES:

- Temperature Rise .....40°C typical at IDC
- Operating Temperature .....-40°C to +125°C(Including self temperature rise)
- Storage Temperature .....-40°C to +125°C
- Soldering .....245°C, 5 seconds max
- Dielectric Strength .....1000 Vrms between windings

### IMPEDANCE COMMON MODE

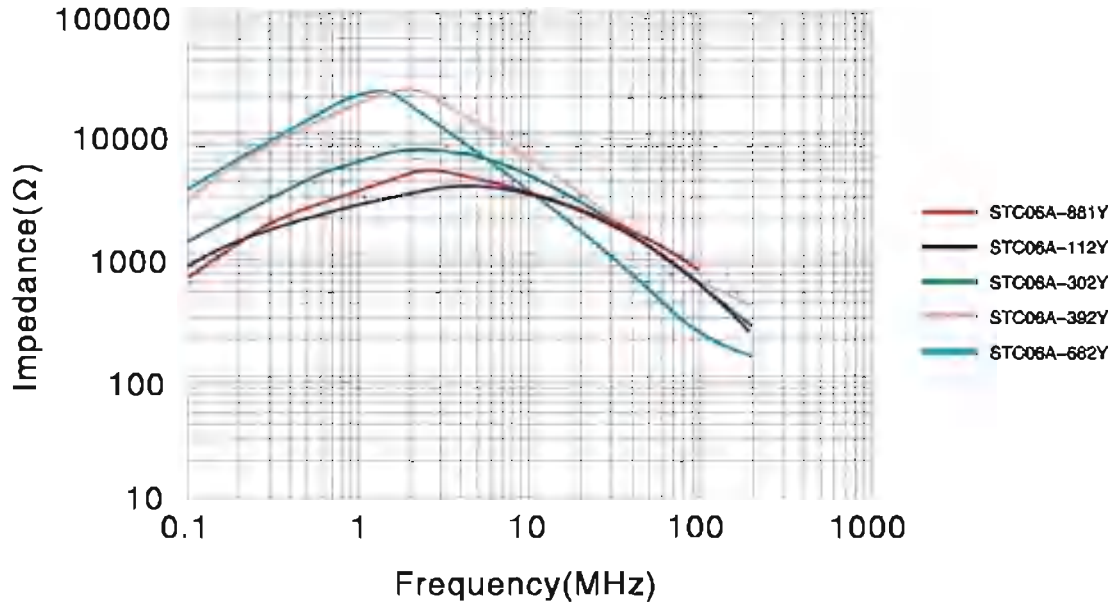

### IMPEDANCE DIFFERENTIAL MODE

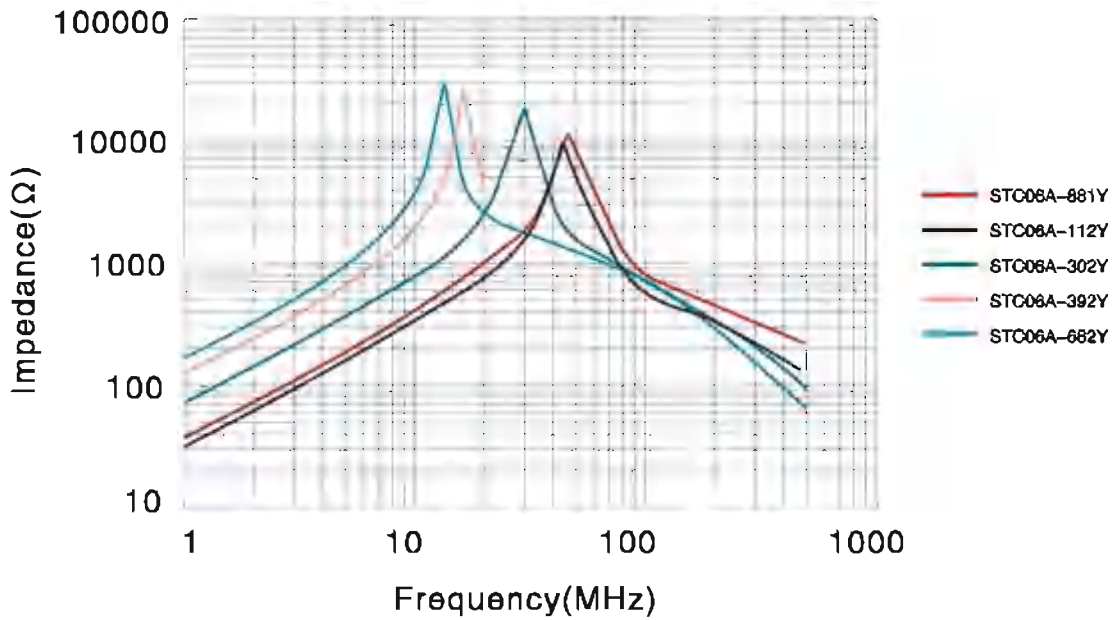



# COMMON MODE CHOKES STC06F SERIES

## FEATURES:

- Inductance range from 34.9uH to 1800uH
- Current range up to 5.7 Amps
- Noise attenuation up to 5.8 dB
- Meets UL84V-0 flammability standard
- Ferrite core material

## OPTIONS:

- Supplied in tape and reel packaging

## COMMON APPLICATIONS:

- EMI filters
- DC-DC brick power supplies
- Discrete output supplies
- Discrete and point-of-use power supplies

## ELECTRICAL CHARACTERISTICS:

Part Number	L(0A) (uH) ± 30% 100KHz,0.1V	I <sub>rms</sub> (A)Max	DCR (mΩ)Typ (1-2)	DCR (mΩ)Typ (4-3)	L <sub>k</sub> (uH) Typ 100KHz,0.1V	Interwinding Capacitance (pF)
STC06F-340Y	34.9	5.70	4.63	4.63	0.31	2.80
STC06F-500Y	50.0	5.10	5.12	5.12	0.46	3.05
STC06F-750Y	75.0	4.75	6.52	6.52	0.64	3.30
STC06F-101Y	105.0	3.95	7.92	7.92	0.85	3.50
STC06F-171Y	175.0	3.10	15.9	15.9	1.30	3.70
STC06F-261Y	260.0	2.85	19.5	19.5	1.90	3.90
STC06F-311Y	310.0	2.45	25.3	25.3	2.20	4.15
STC06F-421Y	420.0	2.00	36.8	36.8	3.00	4.40
STC06F-481Y	480.0	1.70	50.2	50.2	3.30	4.65
STC06F-621Y	620.0	1.45	62.1	62.1	4.20	4.85
STC06F-781Y	780.0	1.20	92.3	92.3	5.10	5.10
STC06F-951Y	950.0	1.05	132.1	132.1	6.10	5.35
STC06F-122Y	1250.0	0.88	192.2	192.2	7.80	5.55
STC06F-182Y	1800.0	0.75	286.5	286.5	9.60	5.80

## PHYSICAL CHARACTERISTICS

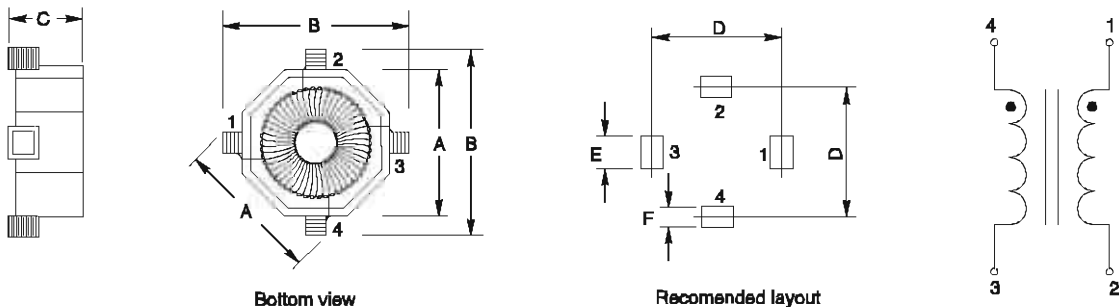

### NOTES:

- Inductance measure at 100KHz 0.1VRms.
- Insulation Resistance: 100Vdc 1KMΩ min.
- Dielectric Strength: 500 Vrms between windings
- Turns Ratio: 1:1
- RDC:QuadTech 1880 Milliohm-meter
- Soldering temperature:260°C for 4 ± 1 seconds
- Operating temperature:-40°C to +125°C
- Storage Temperature: -40°C to +125°C

A	B	C	D	E	F
11.4	14.3Max	6.0Max	12.44	3.5	3.0



# COMMON MODE CHOKES STC07 SERIES

## FEATURES:

- Inductance range from 1mH to 39mH
- Current range up to 3.0 Amps
- Frequency range up to 100 MHz
- Meets UL94V-0 flammability standard
- Ferrite core material

## OPTIONS:

- Packaging: Tape & Reel is standard
- Bulk packaging available for smaller quantities

## COMMON APPLICATIONS:

- EMI filters
- DC-DC brick power supplies
- Discrete output supplies
- Discrete and point-of-use power supplies

## ELECTRICAL CHARACTERISTICS:

Part Number	L(0A) (mH) Min 1.0KHz,0.1V	IDC (A)	DCR (mΩ)Max
STC07-102Y	1	2.0	44.5
STC07-402Y	4	1.5	140
STC07-502Y	5	1.0	200
STC07-103Y	10	0.7	350
STC07-203Y	20	0.5	1000
STC07-393Y	39	0.3	3000

## PHYSICAL CHARACTERISTICS

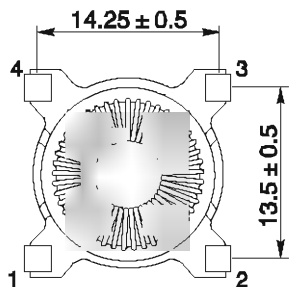
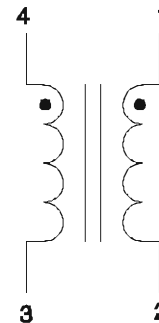
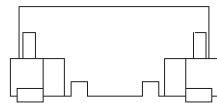
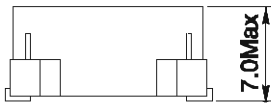
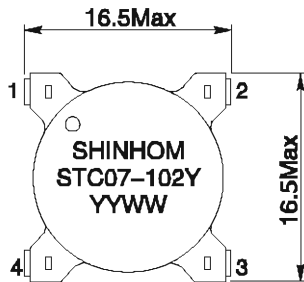

Bottom view

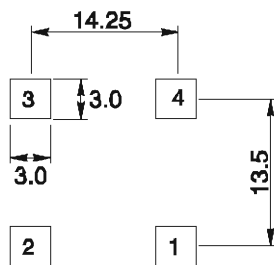

Recommended layout

### NOTES:

1. Temperature Rise ...35°C typical at Irms Operating Temperature .....-55°C to +125°C  
Storage Temperature
2. Storage Temperature .....-55°C to +125°C  
Soldering .....245°C, 5 seconds max. Dielectric Strength .....500 Vrms between windings
3. Core ..... Ferrite
4. Wire ..... Polyester-coated copper
5. Terminal Coating ..... Sn-Ag-Cu alloy

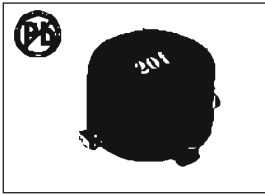

# COMMON MODE CHOKES STC08 SERIES

## FEATURES:

- Inductance range from 0.2mH to 20mH
- Current ranges up to 7.0 Amper
- Noise attenuation up to 44 dB
- Frequency range up to 100 MHz
- Meets UL94V-0 flammability standard
- Ferrite core material

## OPTIONS:

- Supplied in tape and reel packaging

## COMMON APPLICATIONS:

- EMI filters
- DC-DC brick power supplies
- Discrete output supplies
- Discrete and point-of-use power supplies

## ELECTRICAL CHARACTERISTICS:

Part Number	L(0A) (uH) Min 1.0KHz,0.1V	Lk (uH) Typ 100KHz,0.1V	DCR (Ω)Max	IDC (A)Max	Typ Frequency range with 20dB Atten
STC08-201Y	200	1.8	0.008	7.0	5-55MHz
STC08-501Y	500	2.2	0.010	8.0	4-40MHz
STC08-751Y	750	2.9	0.012	6.5	1-20MHz
STC08-102Y	1000	3.9	0.020	4.0	500KHz-40MHz
STC08-202Y	2000	0.3	0.030	3.5	300KHz-20MHz
STC08-502Y	5000	0.4	0.070	2.0	100KHz-10MHz
STC08-103Y	10000	0.5	0.150	1.5	50KHz-5MHz
STC08-203Y	20000	0.7	0.250	1.0	25KHz-4MHz

## PHYSICAL CHARACTERISTICS

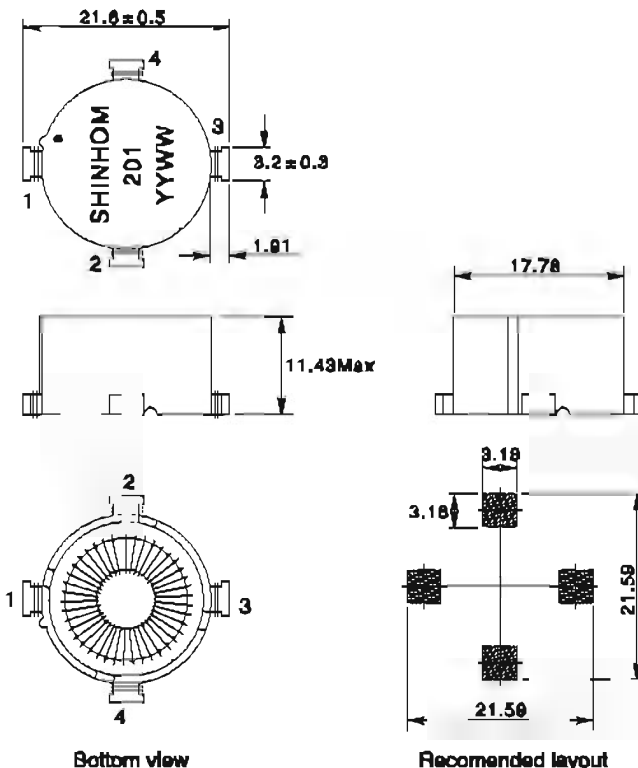

### NOTES:

1. Temperature Rise ...35°C typical at I<sub>rms</sub> Operating Temperature .....-55°C to +125°C Storage Temperature
2. Storage Temperature .....-55°C to +125°C Soldering .....245°C, 5 seconds max. Dielectric Strength .....500 Vrms between windings
3. Core ..... Ferrite
4. Wire ..... Polyester-coated copper
5. Terminal Coating ..... Sn-Ag-Cu alloy

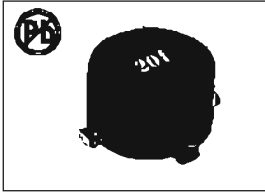

# COMMON MODE CHOKES STC09 SERIES

## FEATURES:

- Inductance range from 25uH to 2500uH
- Current ranges up to 10.0 Amps
- Noise attenuation up to 44 dB
- Frequency range up to 100 MHz
- Meets UL94V-0 flammability standard
- Ferrite core material

## OPTIONS:

- Supplied in tape and reel packaging

## COMMON APPLICATIONS:

- EMI filters
- DC-DC brick power supplies
- Discrete output supplies
- Discrete and point-of-use power supplies

## ELECTRICAL CHARACTERISTICS:

Part Number	L(0A) (uH) ± 25% 1.0KHz, 0.1V	Lk (uH) Typ 100KHz, 0.1V	DCR (Ω) Max	IDC (A) Max
STC09-250Y	25	0.7	0.014	10.0
STC09-500Y	50	0.8	0.014	10.0
STC09-101Y	100	1.4	0.018	9.5
STC09-151Y	150	1.8	0.016	9.5
STC09-201Y	200	2.2	0.018	8.5
STC09-301Y	300	3.3	0.020	7.5
STC09-451Y	450	4.8	0.024	6.5
STC09-651Y	650	6.2	0.030	5.5
STC09-102Y	1000	9.3	0.050	3.5
STC09-152Y	1500	14.5	0.090	2.5
STC09-252Y	2500	21.8	0.162	2.2

## PHYSICAL CHARACTERISTICS

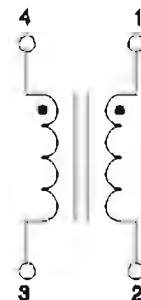
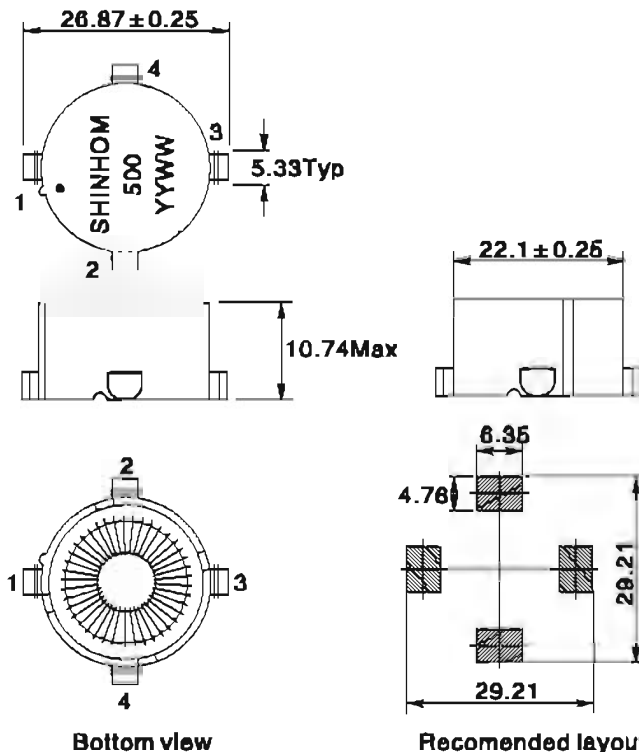

### NOTES:

1. Temperature Rise ...35°C typical at I<sub>rms</sub> Operating Temperature .....-55°C to +125°C Storage Temperature
2. Storage Temperature .....-55°C to +125°C Soldering .....245°C, 5 seconds max. Dielectric Strength .....500 Vrms between windings
3. Core ..... Ferrite
4. Wire ..... Polyester-coated copper
5. Terminal Coating ..... Sn-Ag-Cu alloy

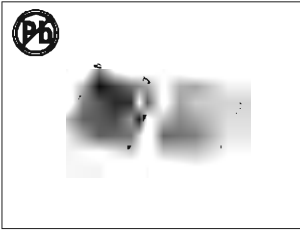

# SMD LINE FILTER STR0602 SERIES

## FEATURES:

- Compact design.
- Single layer winding for minimum capacitance.
- Meets UL 94V-0 flammability standard.
- Available on tape and reel for auto surface mounting.

## APPLICATIONS:

- EMI filters.
- Personal computers.
- Communication equipment.

## ELECTRICAL CHARACTERISTICS:

Part Number	L1=L2(uH ) @10KHz,0.1V ±30%	DCR (winding) (mΩ) max.	Rated Current (A) max.
STR0602-100N	10	25	2.5
STR0602-150N	15	40	2.0
STR0602-200N	20	70	1.5
STR0602-121N	120	25	2.5
STR0602-201N	200	40	2.0
STR0602-301N	300	70	1.5

## TECHNICAL INFORMATION & PHYSICAL CHARACTERISTICS:

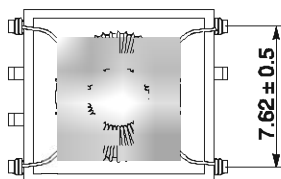
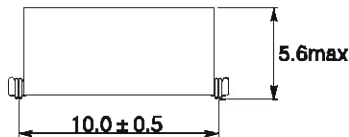
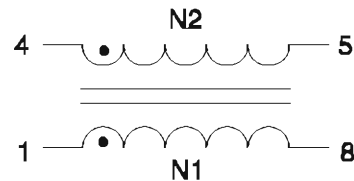
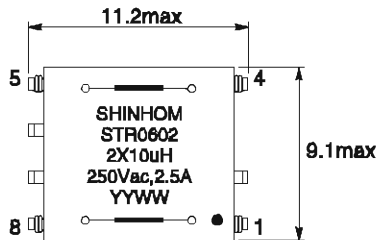

Bottom view

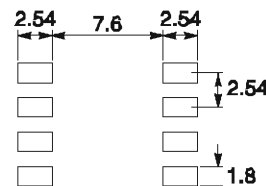

Layout recommendation

- IDC Max: Determined when superimposed
  - Inductance test: HP4284A 10KHz 0.1V
  - RDC: QuadTech 1880 Milliohm meter
  - Operating temperature: -25°C to +105°C
  - Storage Temperature: -25°C to +105°C
  - Solder methods: Vapor Phase, Infrared Reflow
  - Resistance to soldering heat: 260°C for 10 seconds
  - Solvent resistance: Conforms to MIL-STD-202E
  - Marking: Inductance & Date
- Note: All specifications subject to change without notice.

# SMD LINE FILTER STR0603 SERIES

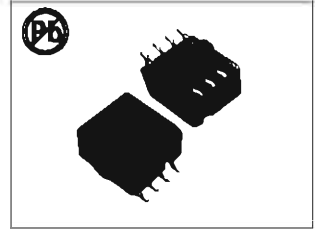

## FEATURES:

- SMD Housing
- High Frequency Design
- Excellent Mechanical Strength
- Excellent Solderability
- High Reliability
- Low Profile

## COMMON APPLICATIONS:

- VCRs
- Video Cameras
- Communication System
- Automotive Systems
- Liquid Crystal Televisions
- Hard Disk Drives
- Network Systems
- Computer Peripheral Equipment

## ELECTRICAL CHARACTERISTICS:

Part Number	L mH	Test Freq KHz	DCR Ω Max	IDC A Max
STR0603-102Y	1.0	1	0.82	0.5
STR0603-501Y	0.5	1	0.45	0.6
STR0603-221Y	0.22	1	0.22	0.8
STR0603-151Y	0.15	1	0.15	1.0

## TECHNICAL INFORMATION & PHYSICAL CHARACTERISTICS:

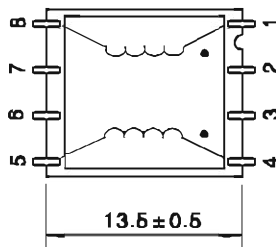
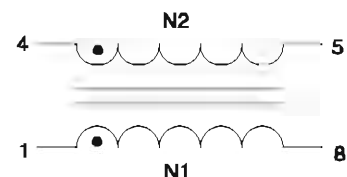
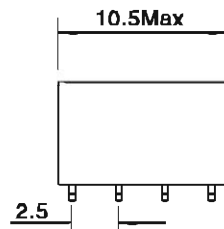
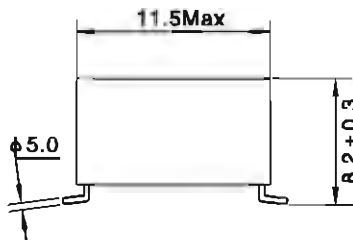

Bottom view

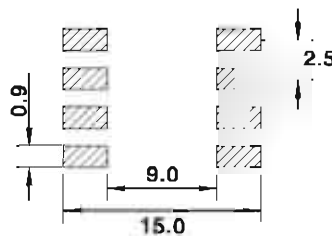

Layout recommendation

- IDC Max: Determined when superimposed
- Testing: (Equivalent acceptable) Inductance: HP4284A  
RDC: QuadTech 1880 Milliohm meter
- Operating temperature: -40°C to +105°C
- Storage Temperature: -40°C to +105°C
- Solder methods: Vapor Phase, Infrared Reflow
- Resistance to soldering heat: 260°C for 10 seconds
- Solvent resistance: Conforms to MIL-STD-202E
- Marking: Inductance & Tolerance

Note: All specifications subject to change without notice.

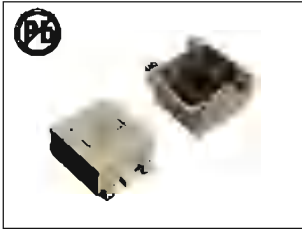

# SMD LINE FILTER STR0903 SERIES

## FEATURES:

- Approx. 0.8% stray inductance for differential-mode interference suppression
- Suitable for reflow soldering
- Design complies with EN 60938-2 (VDE 0585-2)
- RoHS-compatible

## OPTIONS:

- Tape & Reel is Standard (Qty:350pcs)
- Bulk packaging Available for Smaller Quantities

## COMMON APPLICATIONS:

- Suppression of common-mode interferences
- Compact electronic ballasts in lamps
- Compact switch-mode power supplies

## ELECTRICAL CHARACTERISTICS:

Part Number	L(1-6)(mH) @10KHz,0.1V +50%/-30%	LK(1-6)(uH) @10KHz,0.1V (4-5 short)max.	DCR (winding) (mΩ) max.	Rated Current (A) max.	Hi-Pot Vac,25
STR0903-112Y	1.1	6	65	2.0	1500
STR0903-162Y	1.6	10	110	1.5	1500
STR0903-302Y	3.0	20	220	1.0	1500
STR0903-442Y	4.4	30	400	0.8	1500
STR0903-123Y	12	80	1100	0.3	1500
STR0903-223Y	22	130	1600	0.3	1500

## TECHNICAL INFORMATION & PHYSICAL CHARACTERISTICS:

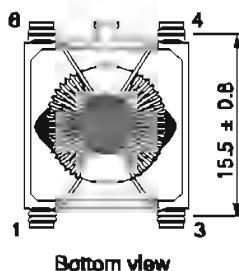
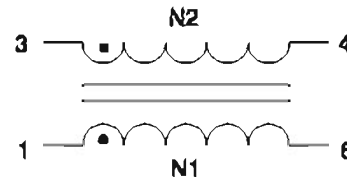
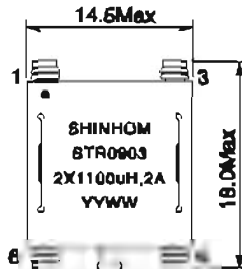

### Layout recommendation

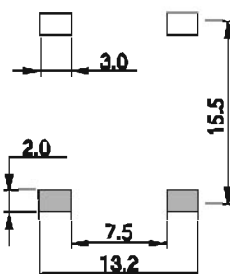

- Operating voltage: 250Vac
- IDC Max: Determined when superimposed
- Inductance test: HP4284A 10KHz 0.1V
- RDC: QuadTech 1880 MilliOhmmeter
- Operating temperature: -40°C to +105°C
- Storage Temperature: -40°C to +105°C
- Temperature rise 40°C Max
- Solder methods: Vapor Phase, Infrared Reflow
- Resistance to soldering heat: 250°C for 10 seconds
- Solvent resistance: Conforms to MIL-STD-202E
- Marking: Inductance & Date

Note: All specifications subject to change without notice.



# SMD LINE FILTER STR1206 SERIES

## FEATURES:

- Approx. 0.8% stray inductance for differential-mode interference suppression
- Suitable for reflow soldering
- Design complies with EN 60938-2 (VDE 0585-2)
- RoHS-compatible

## OPTIONS:

- Tape & Reel is Standard (Qty: 950 pcs)
- Bulk packaging Available for Smaller Quantities

## COMMON APPLICATIONS:

- Suppression of common-mode Interferences
- Compact electronic ballasts in lamps
- Compact switch-mode power supplies

## ELECTRICAL CHARACTERISTICS:

Part Number	L(1-8)(mH) ⊙ 10KHz, 0.1V +50%/-30%	LK(1-8)(uH) ⊙ 10KHz, 0.1V (4-5 short) max.	DCR (winding) (mΩ) max.	Rated Current (A) max.	Hi-Pot Vac, 2S
STR1206-112Y	1.1	6	65	2.0	1500
STR1206-182Y	1.8	10	110	1.5	1500
STR1206-302Y	3.0	20	220	1.0	1500
STR1206-442Y	4.4	30	400	0.8	1500
STR1206-123Y	12	60	1100	0.3	1500
STR1206-223Y	22	130	1600	0.3	1500

## TECHNICAL INFORMATION & PHYSICAL CHARACTERISTICS:

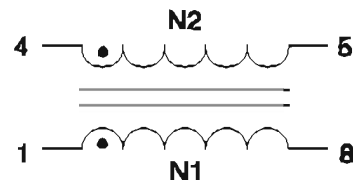
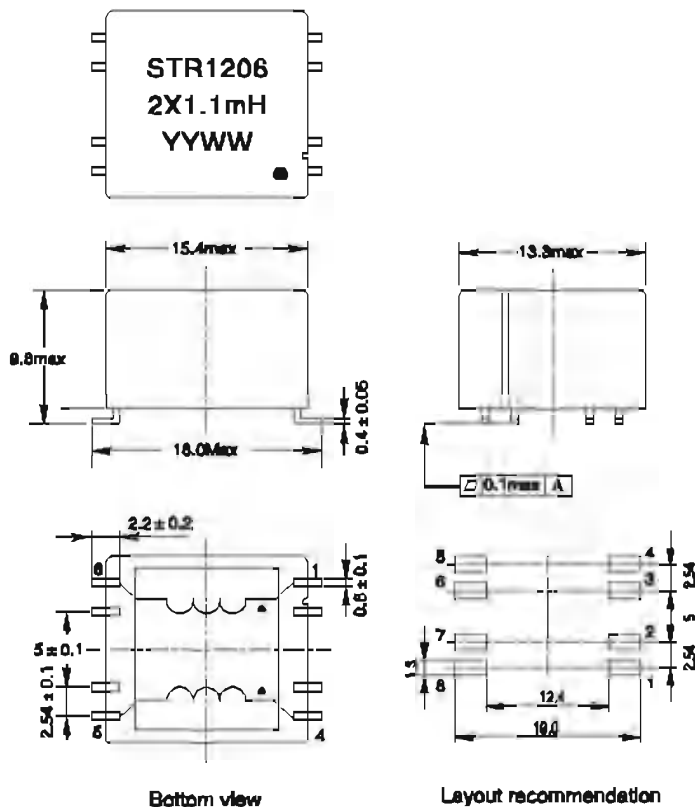

- IDC Max: Determined when superimposed
- Inductance test: HP4284A 10KHz 0.1V
- RDC: QuadTech 1680 Milliohmmeter
- Operating temperature: -40°C to +105°C
- Storage Temperature: -40°C to +105°C
- Solder methods: Vapor Phase, Infrared Reflow
- Resistance to soldering heat: 260°C for 10 seconds
- Solvent resistance: Conforms to MIL-STD-202E
- Marking: Inductance & Date

Note: All specifications subject to change without notice.

# COMMON MODE CHOKE COIL STR804 SERIES

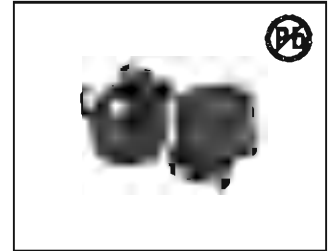

## FEATURES:

- Wire wound constructure common mode choke with best EMI suppression effect high impedance but very high rated current and low DCR.

## APPLICATIONS :

- Preventive measure against common mode noise radiation emissions from power line or else.
- Best for high current circuit such as car, wireless charging and power device design.

## ELECTRICAL CHARACTERISTICS@25°C

Part Number	Impedance (Ω)Ref N1=N2	Test frequency	DCR (mΩ)Max	IDC (A)Max
STR804-102	1000	100KHz/0.25V	100	2.5
STR804-132	1300	100KHz/0.25V	115	2.4
STR804-162	1600	100KHz/0.25V	130	2.3

## PHYSICAL CHARACTERISTICS & WINDING

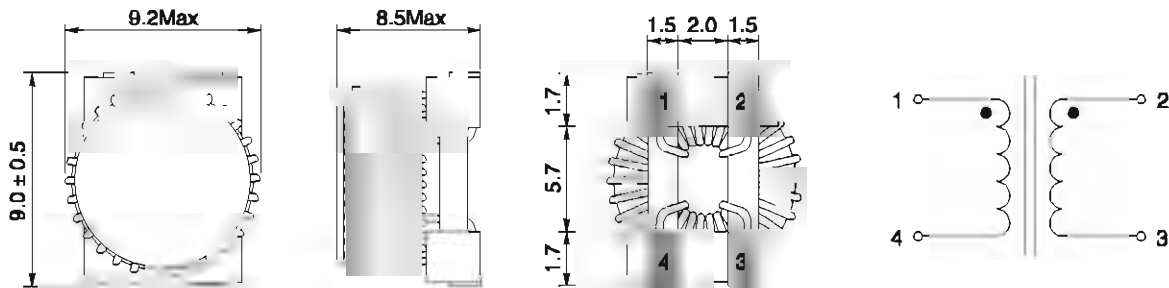

STR804-102

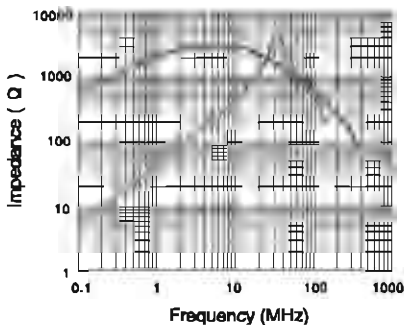

STR804-132

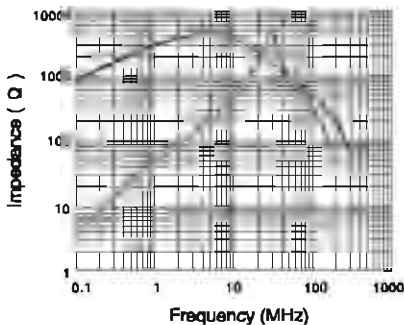

STR804-162

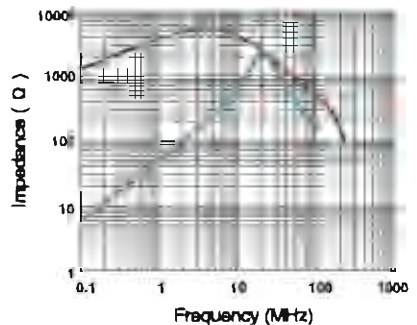

- Common mode
- Differential mode

## Note:

- Z test with HP4181A or HP4396A
- RDC:QuadTech 1880 Milliohmeter
- Operating temperature: -40°C to +105°C
- Storage Temperature: -40°C to +105°C
- Resistance to soldering heat:260°C for 10 seconds

Note:All specifications subject to change without notice.

# SMT COMMON MODE CHOKES

## STRF01 SERIES

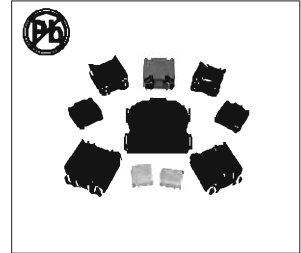

### FEATURES:

- Common mode chokes for AC power lines
- High Impedance to minimize common mode noise
- Excellent EMI performance
- Meets UL94V-0 flammability standard

### APPLICATIONS:

- EMI filters
- DC-DC brick power supplies
- Discrete output supplies
- Discrete and point-of-use power supplies

## ELECTRICAL CHARACTERISTICS:

Part Number	L(0A) (uH)Min 10KHz,0.1V	IDC (A)Max	DCR (mΩ)Max	Hi-Pot 1mA/2S/60Hz (Vac)
STRF01-651Y	650	3.6	50	1000
STRF01-801Y	800	1.5	60	1000
STRF01-152Y	1500	1.5	60	1000
STRF01-602Y	6000	1.0	450	1000
STRF01-153Y	15000	1.0	600	1000

## PHYSICAL CHARACTERISTICS & WINDING

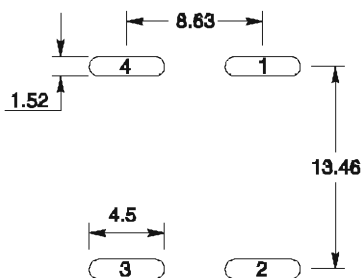
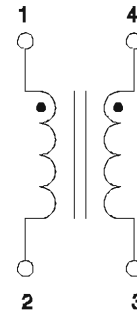
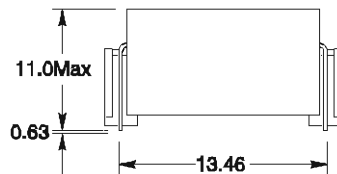
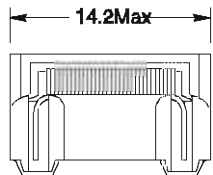
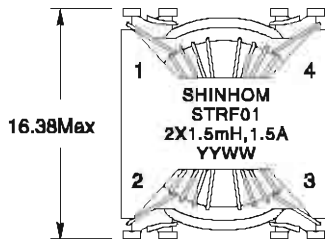

Pad layout

### NOTES:

- Temperature Rise .....40°C typical at IDC
- Operating Temperature .....-40°C to +125°C(Including self temperature rise)
- Storage Temperature .....-40°C to +125°C
- Soldering .....245°C, 5 seconds max
- Dielectric Strength .....1000 Vrms between windings

## IMPEDANCE COMMON MODE

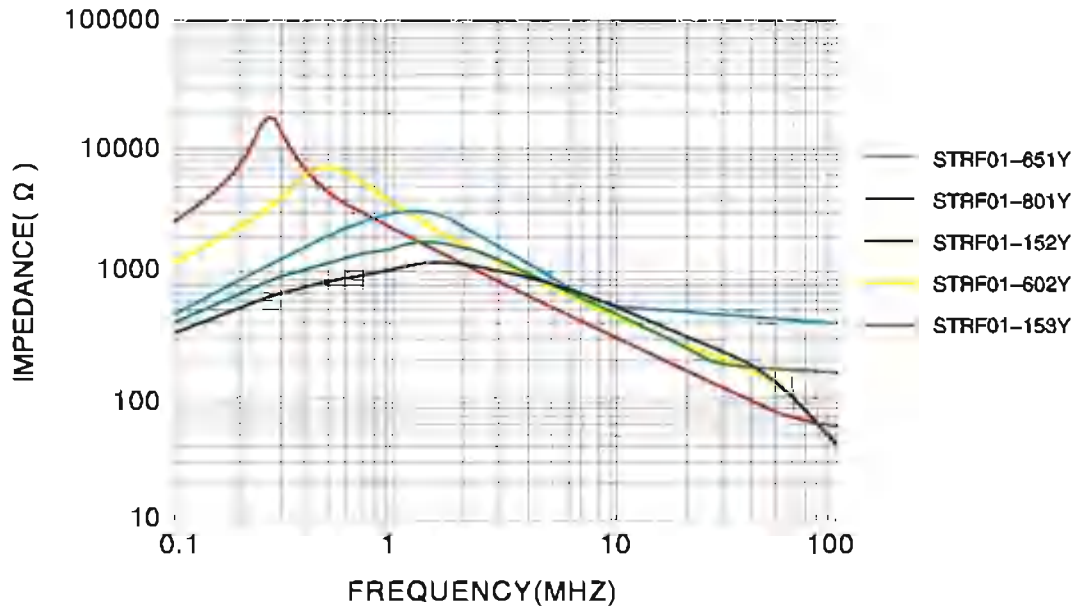

## IMPEDANCE DIFFERENTIAL MODE

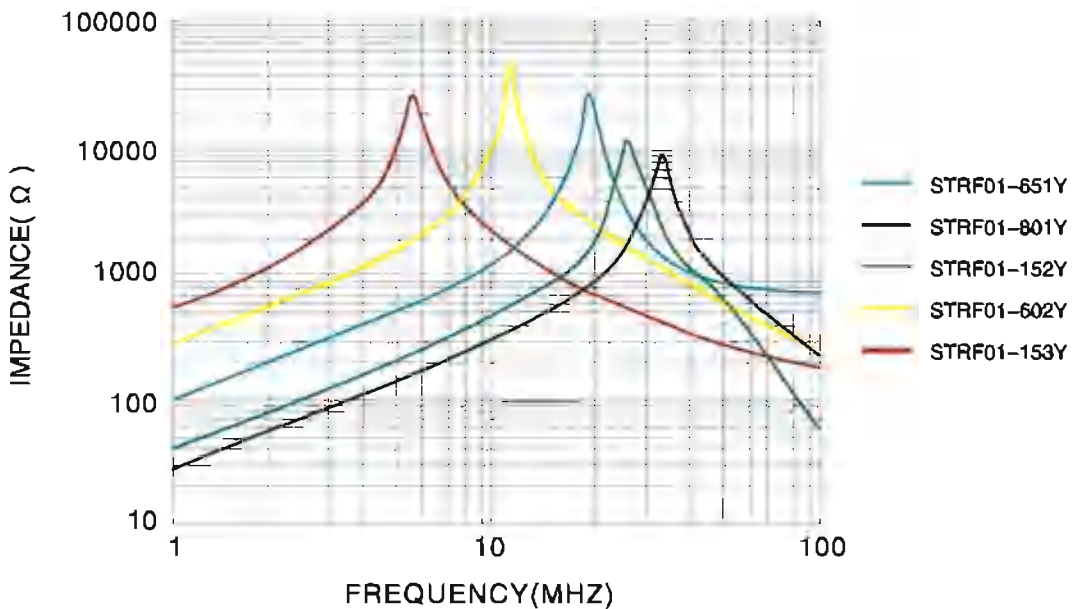

# COMMON MODE POWER LINE CHOKE

## STRF012 SERIES

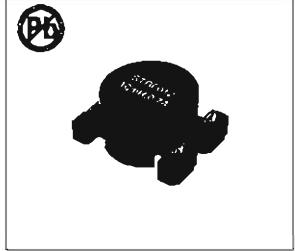

### FEATURES:

- SMD Power line choke
- Compact size
- Toroidal core with sector winding
- High attenuation of common mode interferences in low and middle frequency range

### APPLICATIONS:

- Power electronics
- SMPS
- Mains filter

### ELECTRICAL CHARACTERISTICS:

Part Number	L (mH)	Tolerance (%)	Rated Current (A)	RDC max. (Ω)
STRF012-701N	0.7	± 30	4.0	0.03
STRF012-102N	1.0		2.0	0.06
STRF012-222N	2.2		2.0	0.10
STRF012-332N	3.3		1.5	0.15
STRF012-682N	6.8		1.0	0.30
STRF012-103N	10		0.7	0.55
STRF012-273N	27		0.4	1.20
STRF012-393N	39		0.4	1.70
STRF012-473N	47		0.3	2.60

### PHYSICAL CHARACTERISTICS:

Dimensions 1

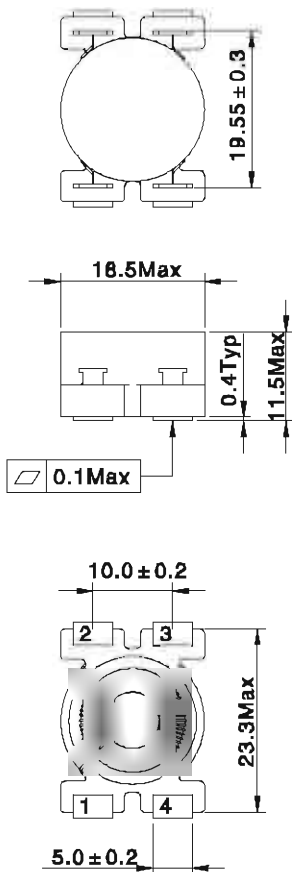

Winding

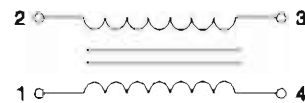

Pad layout

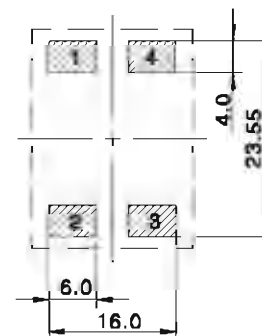

**NOTES:**

- Temperature Rise .....40°C typical at IDC
- Operating Temperature .....-40°C to +125°C(Including self temperature rise)
- Storage Temperature .....-40°C to +125°C
- Soldering .....245°C, 5 seconds max
- Dielectric Strength .....1000 Vrms between windings

**ATTENUATION COMMON MODE**

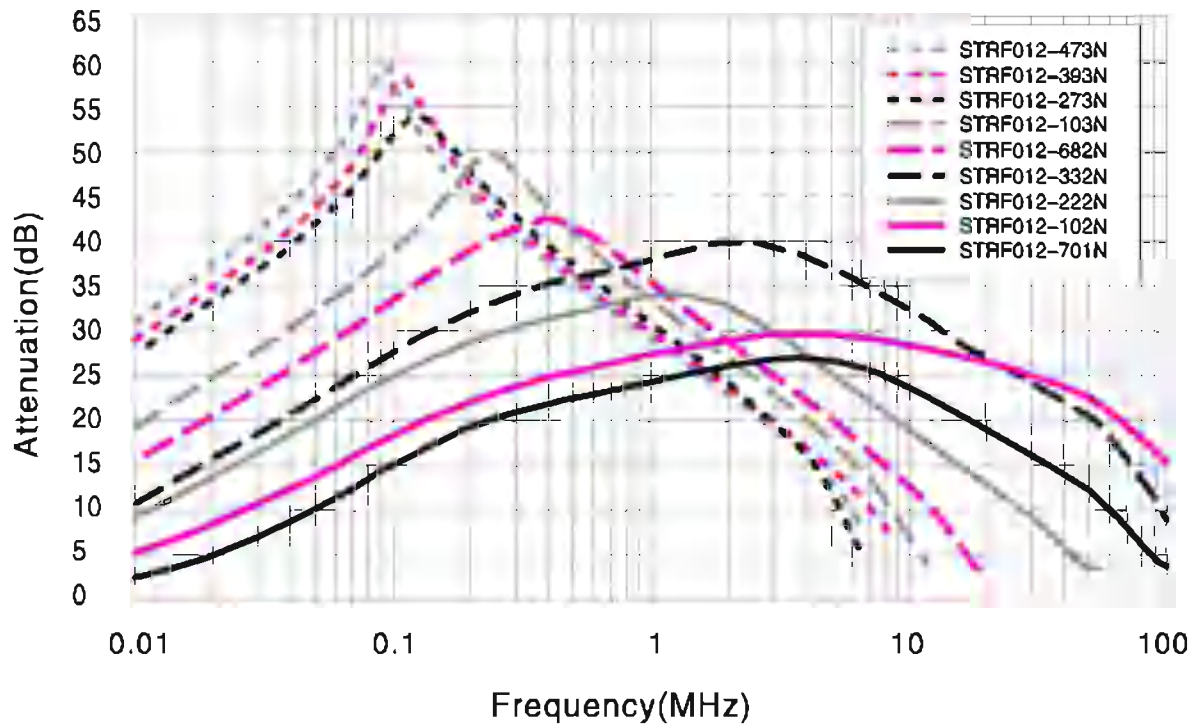

**ATTENUATION DIFFERENTIAL MODE**

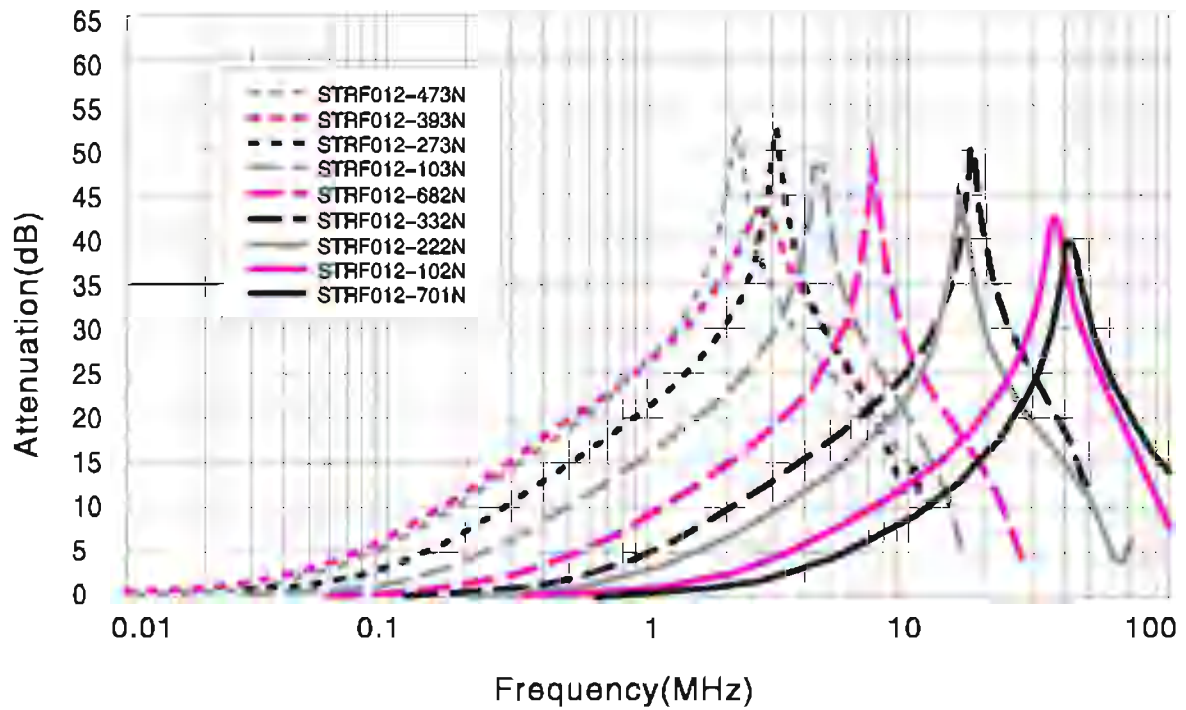

# SMT COMMON MODE CHOKES

## STRF04 SERIES

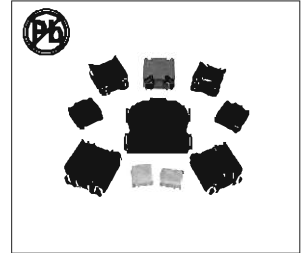

### FEATURES:

- Common mode chokes for AC power lines
- High Impedance to minimize common mode noise
- Excellent EMI performance
- Meets UL94V-0 flammability standard

### APPLICATIONS:

- EMI filters
- DC-DC brick power supplies
- Discrete output supplies
- Discrete and point-of-use power supplies

## ELECTRICAL CHARACTERISTICS:

Part Number	L(0A) (uH) ± 35% 10KHz,0.1V	IDC (A)Max	DCR (mΩ)Max	Hi-Pot 1mA/2S/60Hz (Vac)
STRF04-221Y	225	3.3	60	1000
STRF04-591Y	590	5.6	21	1000
STRF04-771Y	770	4.7	40	1000
STRF04-132Y	1320	3.3	60	1000
STRF04-152Y	1470	2.8	80	1000

## PHYSICAL CHARACTERISTICS & WINDING

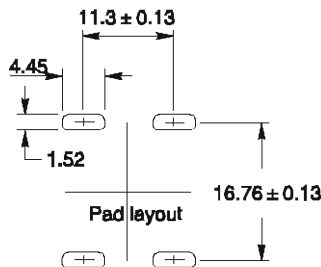
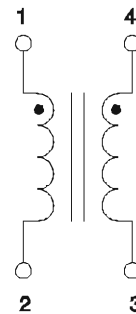
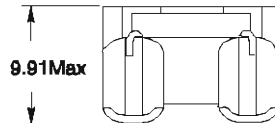
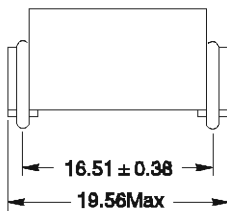

### NOTES:

- Temperature Rise .....40°C typical at IDC
- Operating Temperature .....-40°C to +125°C(Including self temperature rise)
- Storage Temperature .....-40°C to +125°C
- Soldering .....245°C, 5 seconds max
- Dielectric Strength .....1000 Vrms between windings

### IMPEDANCE COMMON MODE

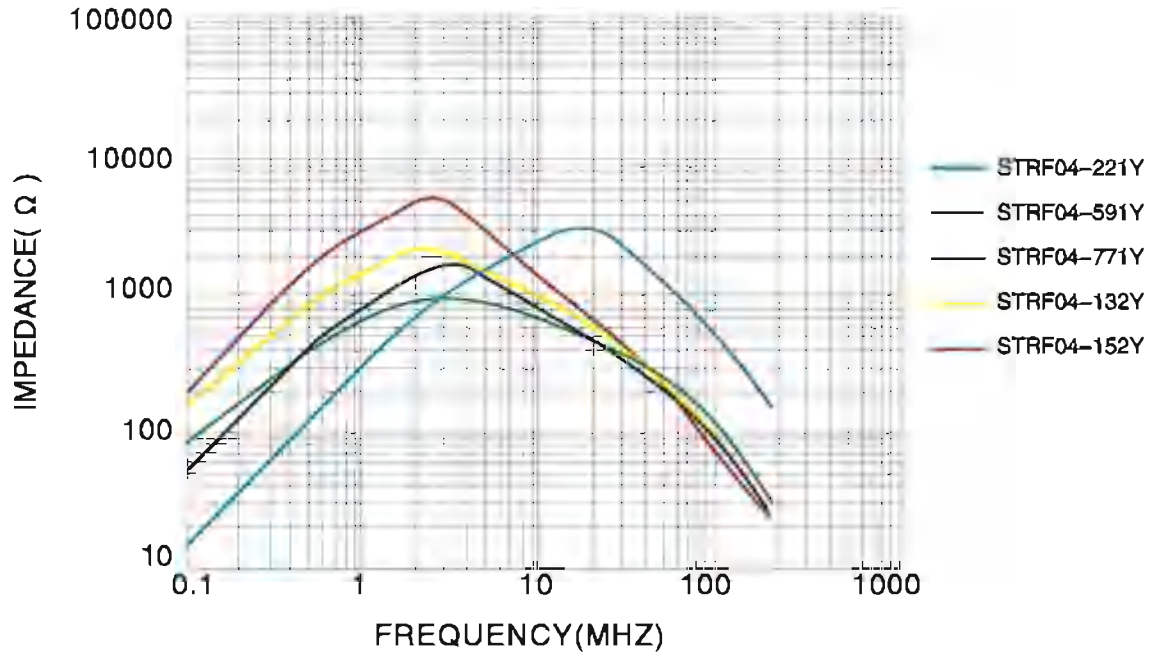

### IMPEDANCE DIFFERENTIAL MODE

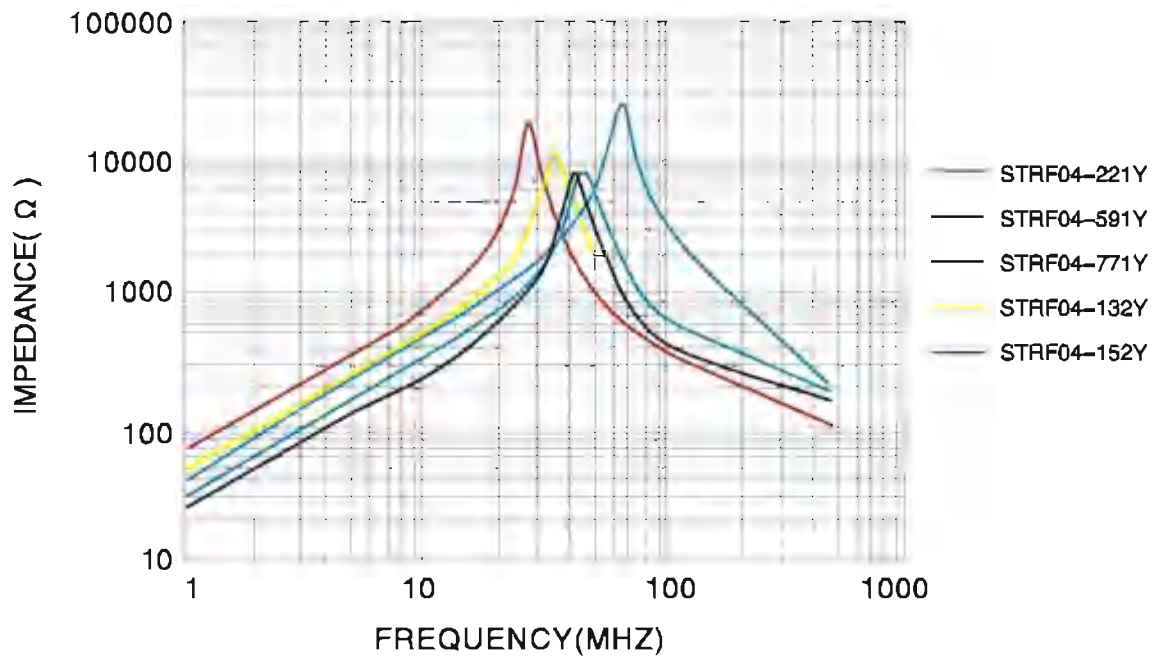

# SMT COMMON MODE CHOKES

## STRF06 SERIES

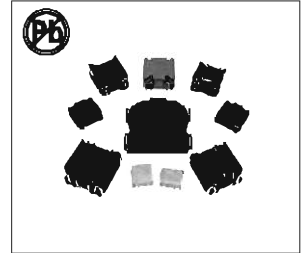

### FEATURES:

- Common mode chokes for AC power lines
- High Impedance to minimize common mode noise
- Excellent EMI performance
- Meets UL94V-0 flammability standard

### APPLICATIONS:

- EMI filters
- DC-DC brick power supplies
- Discrete output supplies
- Discrete and point-of-use power supplies

## ELECTRICAL CHARACTERISTICS:

Part Number	L(0A) (uH) ± 35% 100KHz,0.1V	IDC (A)Max	DCR (mΩ)Max	Hi-Pot 1mA/2S/60Hz (Vac)
STRF06-881Y	880	1.63	110	1000
STRF06-112Y	1170	1.22	200	1000
STRF06-302Y	3000	0.85	280	1000
STRF06-392Y	3900	0.85	350	1000
STRF06-682Y	6800	0.30	700	1000

## PHYSICAL CHARACTERISTICS & WINDING

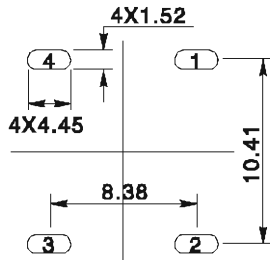
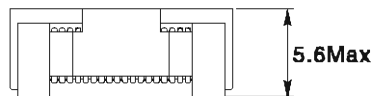
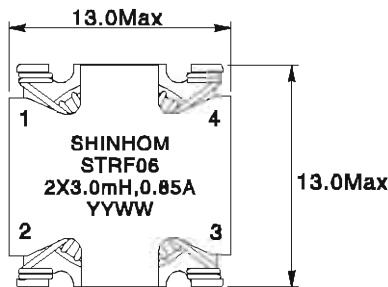

Pad layout

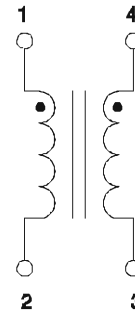

### NOTES:

- Temperature Rise .....40°C typical at IDC
- Operating Temperature .....-40°C to +125°C(Including self temperature rise)
- Storage Temperature .....-40°C to +125°C
- Soldering .....245°C, 5 seconds max
- Dielectric Strength .....1000 Vrms between windings

### IMPEDANCE COMMON MODE

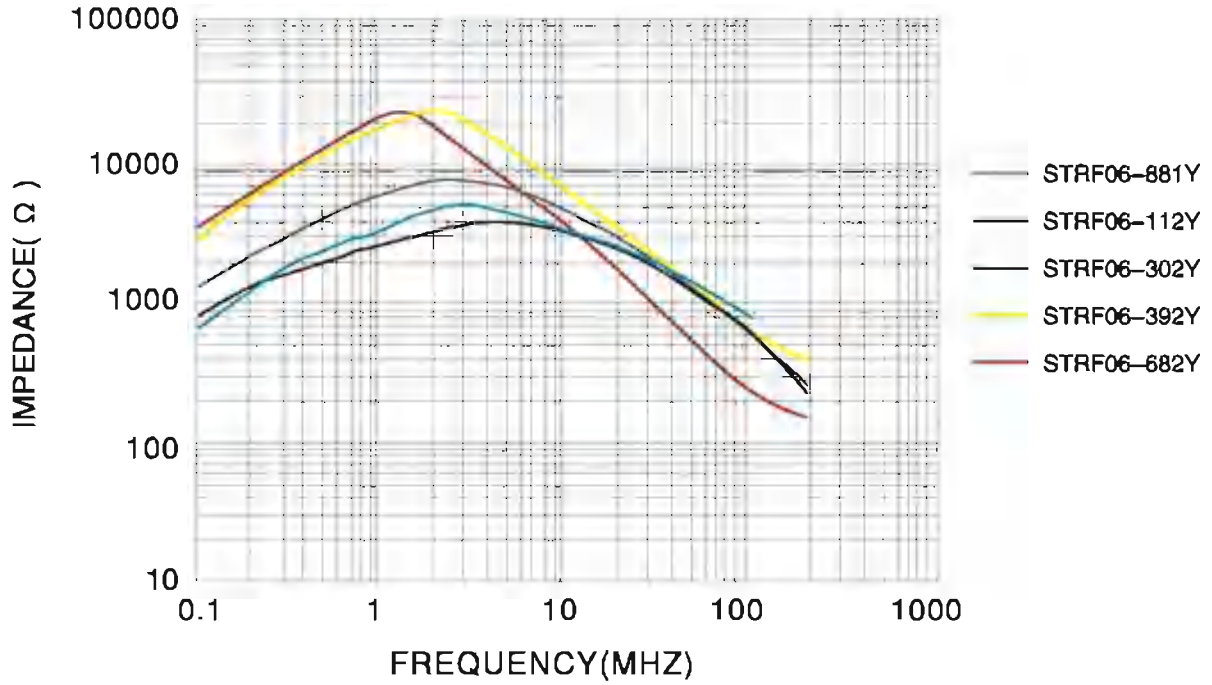

### IMPEDANCE DIFFERENTIAL MODE

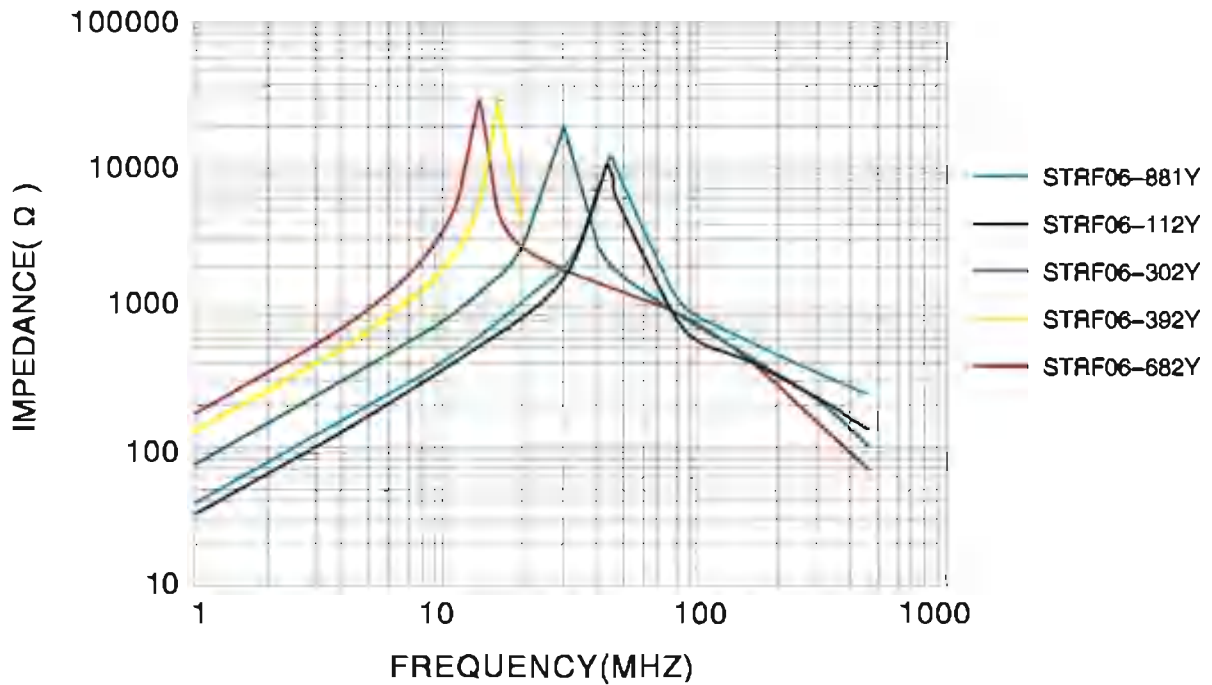

# COMMON MODE CHOKE STRF07 SERIES



## FEATURES:

- Common mode chokes for AC power lines
- High Impedance to minimize common mode noise
- Excellent EMI performance
- Meets UL94V-0 flammability standard

## APPLICATIONS:

- EMI filters
- DC-DC brick power supplies
- Discrete output supplies
- Discrete and point-of-use power supplies

## ELECTRICAL CHARACTERISTICS:

Part Number	L(0A) (mH) Min 10KHz,0.1V	DCR (mΩ)Max	IDC (A)Max	HI-Pot (Vdc) 50Hz,1mA,1S
STRF07-651Y	0.65	20	3	1000
STRF07-801Y	0.8	33	2.4	1000
STRF07-152Y	1.5	70	1.6	1000
STRF07-802Y	6.0	200	0.8	1000
STRF07-103Y	10.0	500	0.5	1000

## PHYSICAL CHARACTERISTICS

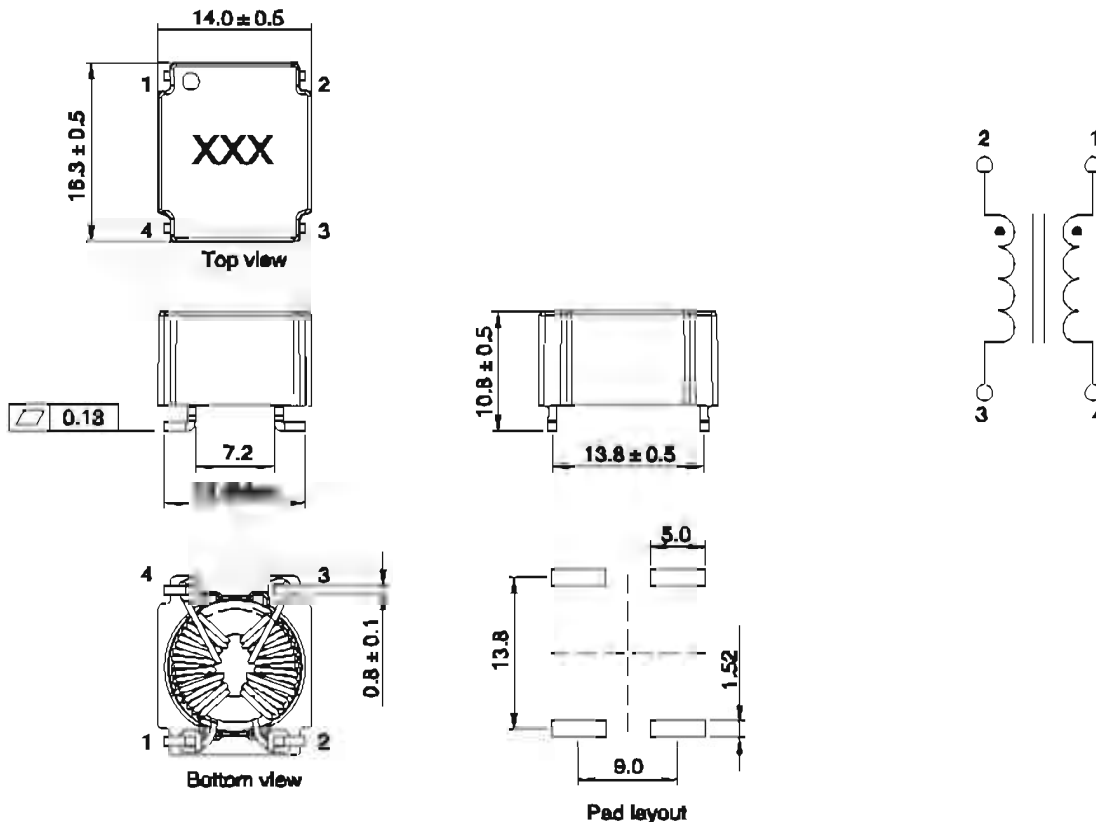

### NOTES:

- Temperature Rise .....40℃ typical at IDC
- Operating Temperature .....-40℃ to +125℃(including self temperature rise)
- Storage Temperature .....-40℃ to +125℃
- Soldering .....245℃, 5 seconds max
- Dielectric Strength .....1000 Vrms between windings

### IMPEDANCE COMMON MODE

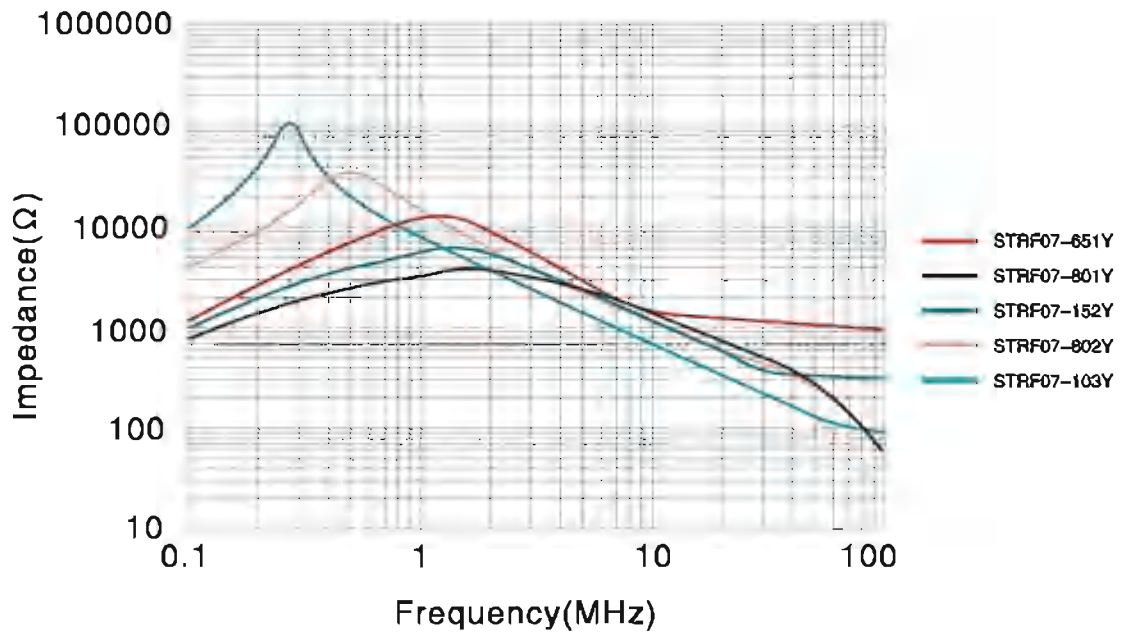

### IMPEDANCE DIFFERENTIAL MODE

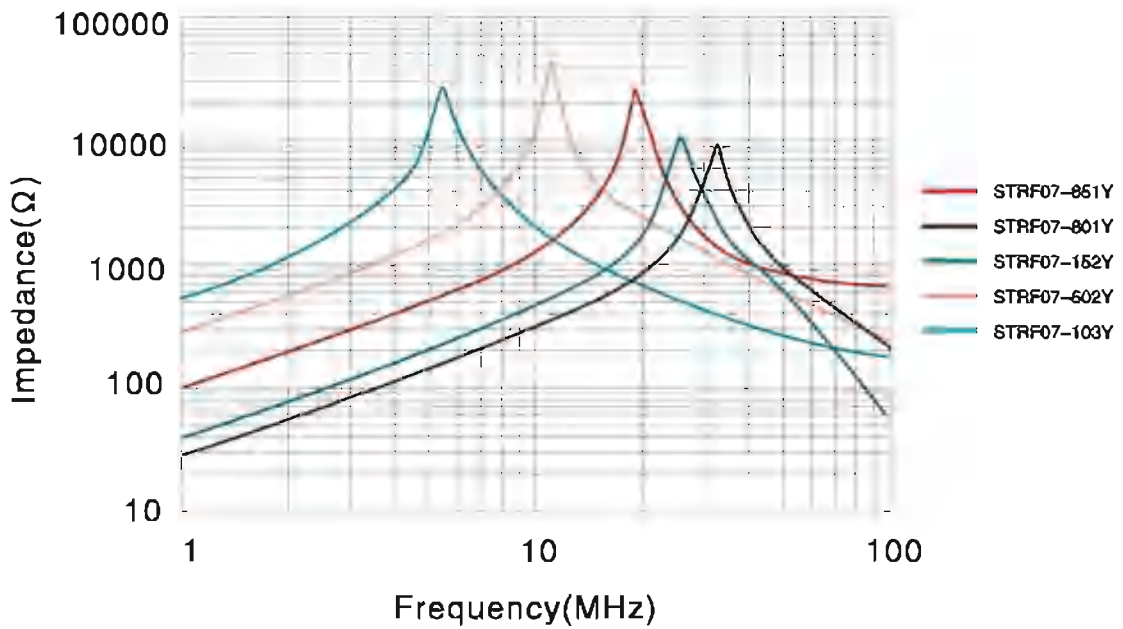

# SMT COMMON MODE CHOKES

## STRF16 SERIES

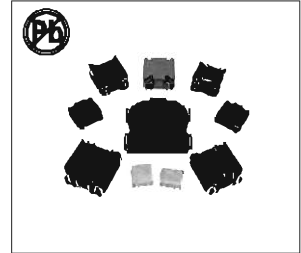

### FEATURES:

- Common mode chokes for AC power lines
- High Impedance to minimize common mode noise
- Excellent EMI performance
- Meets UL94V-0 flammability standard

### APPLICATIONS:

- EMI filters
- DC-DC brick power supplies
- Discrete output supplies
- Discrete and point-of-use power supplies

## ELECTRICAL CHARACTERISTICS:

Part Number	L(0A) (uH) ± 35% 100KHz,0.1V	IDC (A)Max	DCR (mΩ)Max	Hi-Pot 1mA/2S/60Hz (Vac)
STRF016□-131Y	135	26	3.5	1000
STRF016□-221Y	225	20	6.0	1000
STRF016□-471Y	470	14	8.0	1000
STRF016□-631Y	630	11.6	10	1000
STRF016□-821Y	820	7.0	15	1000

## PHYSICAL CHARACTERISTICS & WINDING

STRF016A

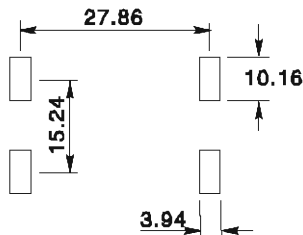
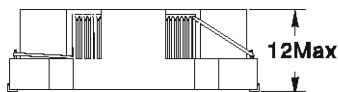
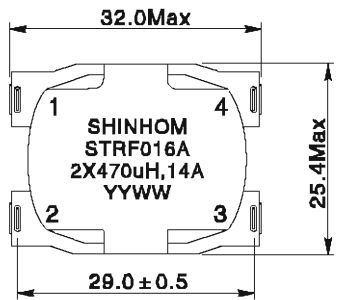

Suggested pad layout

STRF016B

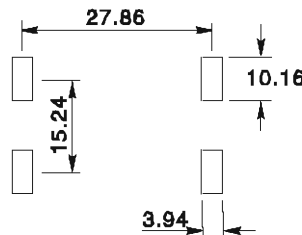
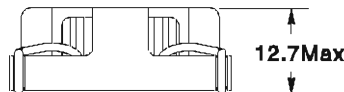
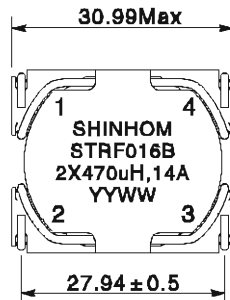

Suggested pad layout

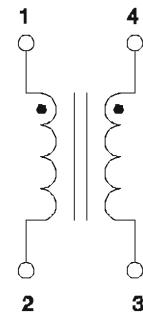

### NOTES:

- Temperature Rise .....40°C typical at IDC
- Operating Temperature .....-40°C to +125°C(Including self temperature rise)
- Storage Temperature .....-40°C to +125°C
- Soldering .....245°C, 5 seconds max
- Dielectric Strength .....1000 Vrms between windings

## IMPEDANCE COMMON MODE

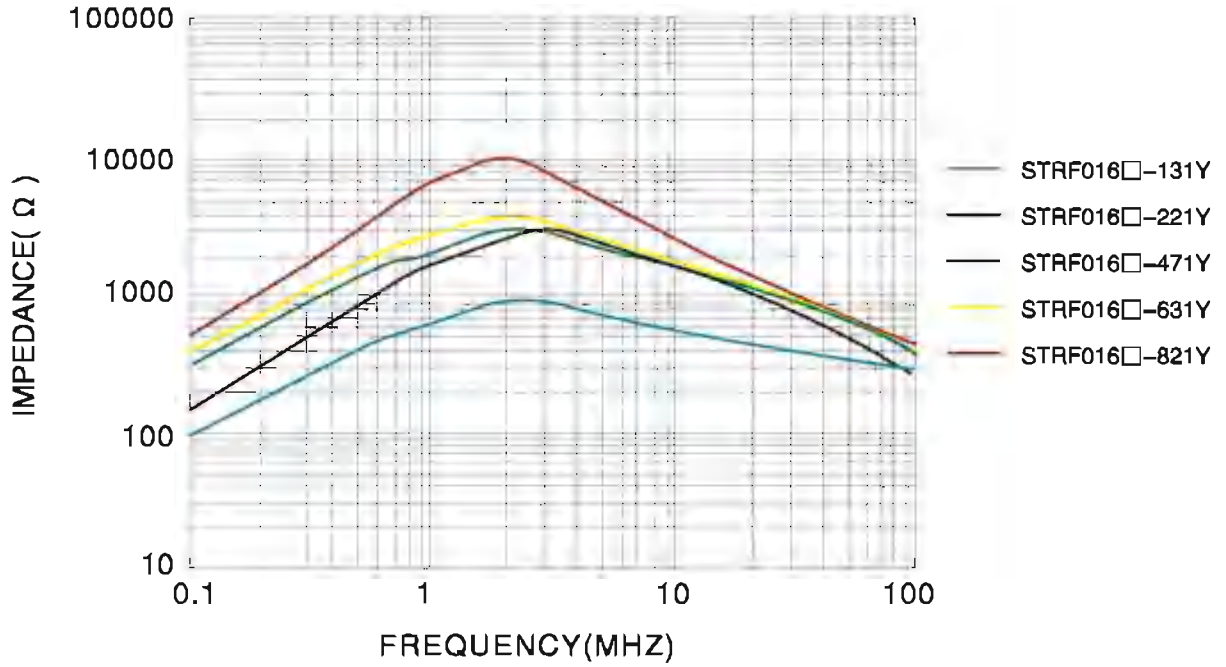

## IMPEDANCE DIFFERENTIAL MODE

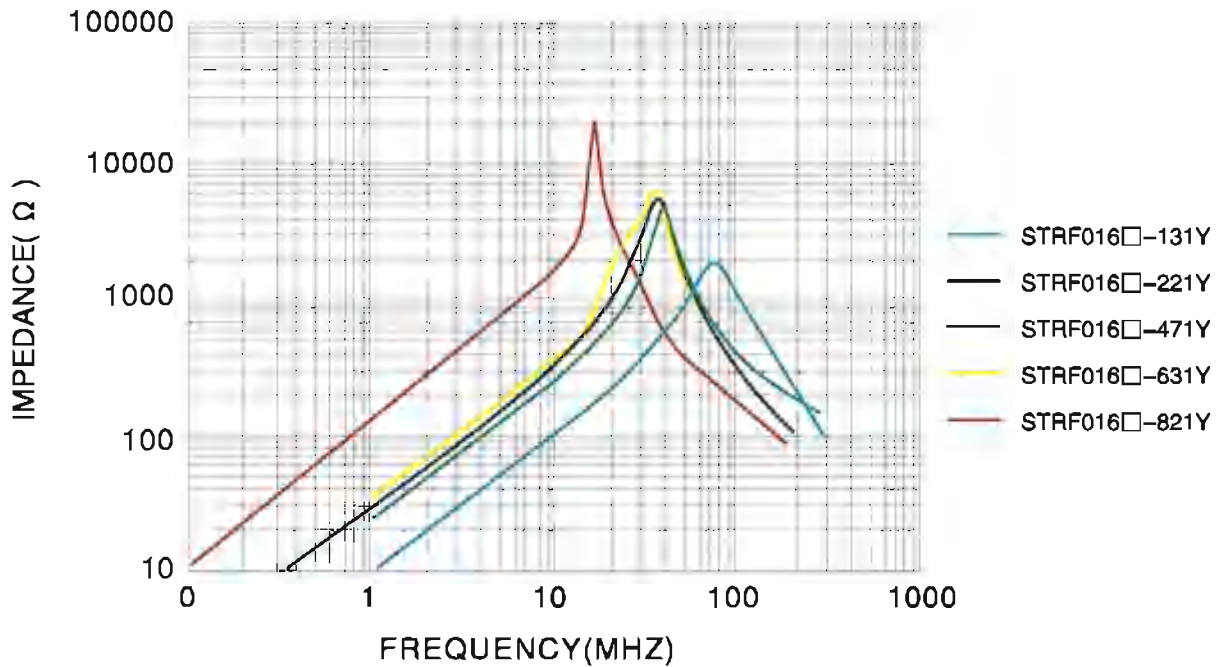

# WIRE-WOUND SMT POWER COMMON-MODE CHOKES STRF2210 SERIES

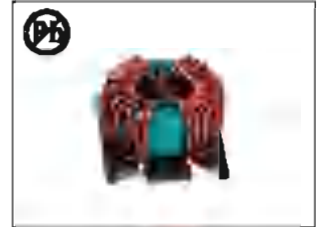

## FEATURES:

- Small size with high current
- Stable performance under load bias and high reliability
- High suppression of asymmetric interferences at both low and high frequency
- SMT Type with less height

## APPLICATIONS:

- Interferences suppression of common mode noise
- Power line filter
- Switch-mode power supplies

## ELECTRICAL CHARACTERISTICS:

Part Number	Inductance (uH) +35%/-40%	Turns ratio 20KHz, 1V N1:N2	DCR (Ω) Max	Rated Current (A) Max	HI-Pot 60Hz, 10mA, 28 (V)
STRF2210-680Y	68	1:1	0.68	50	1500
STRF2210-181Y	180	1:1	1.35	32	1500
STRF2210-321Y	320	1:1	2.5	28	1500
STRF2210-621Y	620	1:1	3.5	20	1500
STRF2210-801Y	800	1:1	6.3	18	1500
STRF2210-132Y	1300	1:1	10	11	1500
STRF2210-182Y	1800	1:1	14	9	1500

## TECHNICAL INFORMATION & PHYSICAL CHARACTERISTICS:

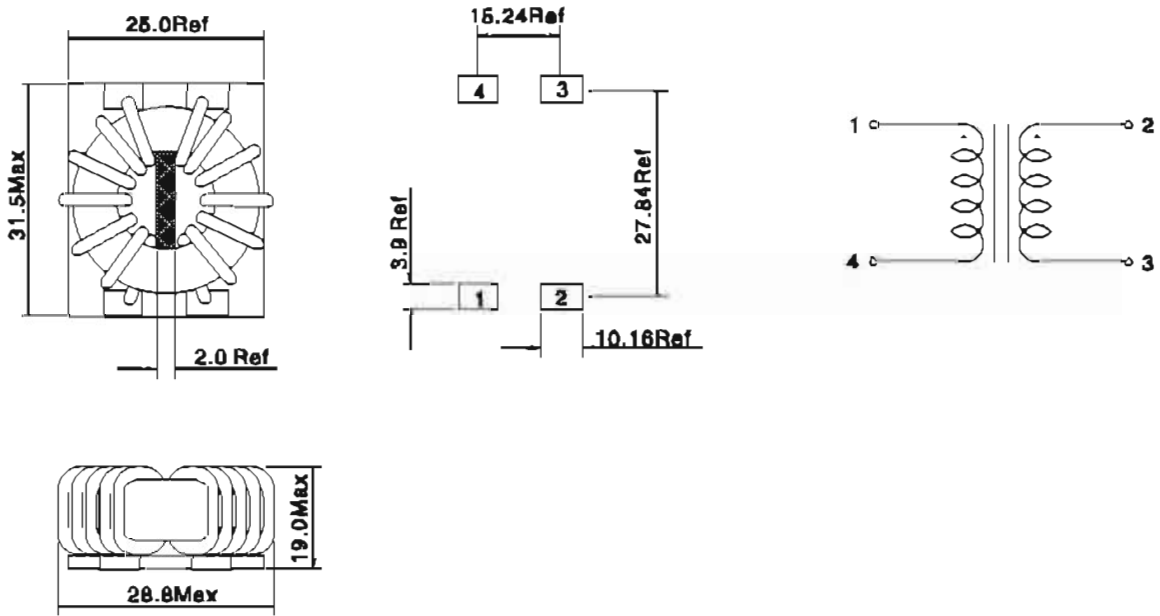

- Inductance Testing: 100KHz, 0.1V
- Operating temperature: -40°C to +125°C (Including self temperature rise)
- Storage Temperature: -40°C to +125°C
- Resistance to soldering heat: 280°C for 10 seconds

Note: All specifications subject to change without notice.

# WIRE-WOUND SMT POWER COMMON-MODE CHOKES STRF2210 SERIES

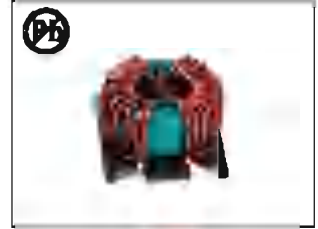

## IMPEDANCE vs FREQUENCY:

STRF2210-880Y

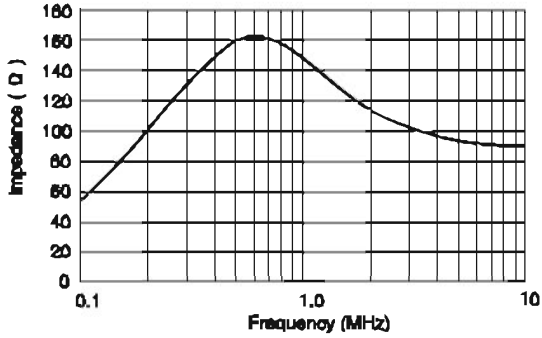

STRF2210-181Y

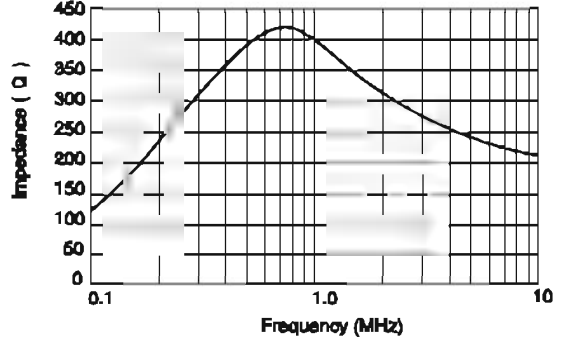

STRF2210-321Y

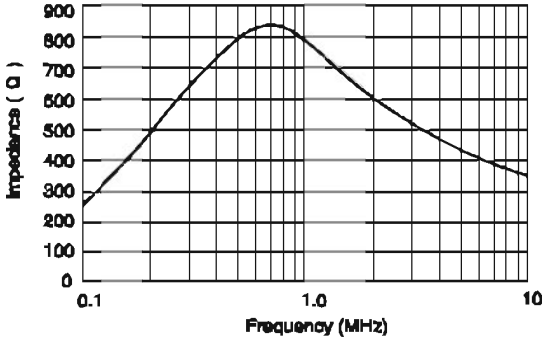

STRF2210-621Y

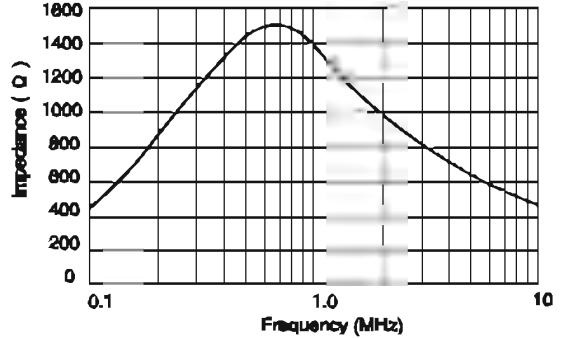

STRF2210-801Y

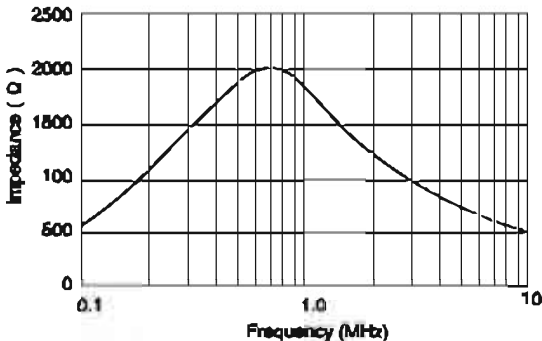

STRF2210-132Y

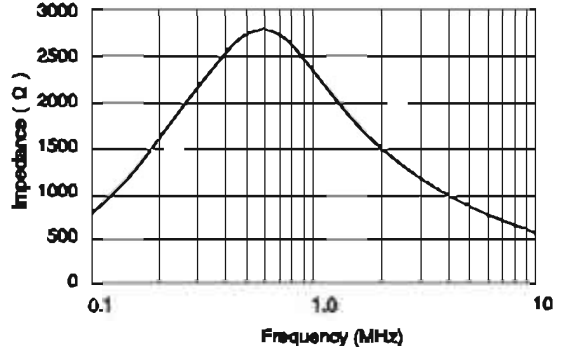

STRF2210-182Y

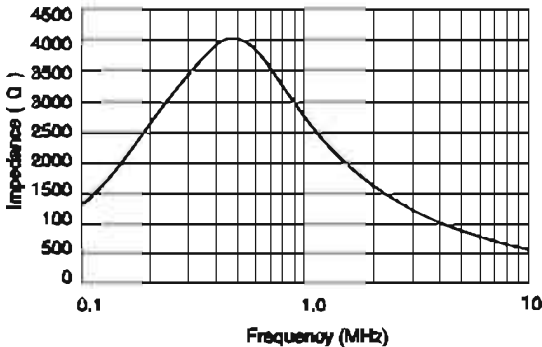

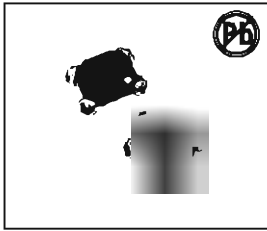

# SMD COMMON MODE CHOKES

## STS01 SERIES

### FEATURES:

- Inductance range from 4.5uH to 205uH
- Current range up to 7.0 Amps
- High resonant frequency
- Meets UL94V-0 flammability standard
- Ferrite core material

### OPTIONS:

- Packaging: Tape & Reel is standard
- Bulk packaging available for smaller quantities

### COMMON APPLICATIONS:

- EMI filters
- DC-DC brick power supplies
- Discrete output supplies
- Discrete and point-of-use power supplies

### ELECTRICAL CHARACTERISTICS:

Part Number	L(0A) (uH) Min 100KHz,0.1V	Leakage inductance (uH) Typ	DCR (Ω) Typ	I <sub>rms</sub> (A) ΔT=40°C	Interwinding Capacitance (pF) Typ
STS01-4R5Y	4.5	0.05	0.0027	7.0	2.0
STS01-8R0Y	8	0.09	0.0040	5.7	2.1
STS01-120Y	12.6	0.14	0.0077	4.1	2.2
STS01-180Y	18	0.20	0.0089	3.8	2.3
STS01-250Y	25	0.28	0.01	3.6	2.4
STS01-320Y	32.8	0.36	0.0138	3.1	2.5
STS01-410Y	41.5	0.45	0.019	2.6	2.6
STS01-510Y	51.2	0.56	0.026	2.2	2.7
STS01-620Y	62	0.68	0.035	1.9	2.7
STS01-730Y	73.7	0.81	0.048	1.65	2.8
STS01-101Y	100	1.10	0.07	1.35	2.9
STS01-131Y	131	1.45	0.1	1.15	3.0
STS01-161Y	166	1.83	0.138	1.0	3.1
STS01-201Y	205	2.25	0.186	0.85	3.2

### PHYSICAL CHARACTERISTICS & WINDING

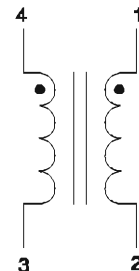
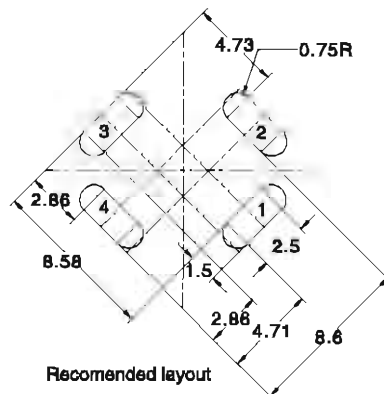
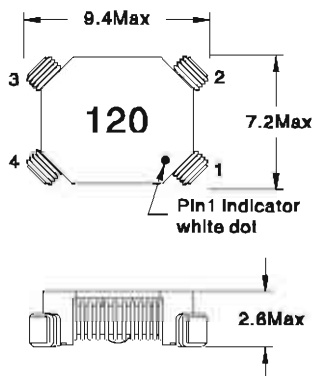

#### NOTES:

1. Inductance tested at 100KHz,0.1V
2. DCR Measured at 20°C
3. Hi-Pot: 300V for 1min. between windings
4. I<sub>rms</sub> current: current for approx. a 40°C temperature rise at an ambient temperature of 85°C
6. Operating temperature: -40°C to +125°C
7. Storage temperature: -40°C to +105°C

# MAGNETIC SHIELDED SURFACE-MOUNT POWER INDUCTORS

## SDRH0603 SERIES

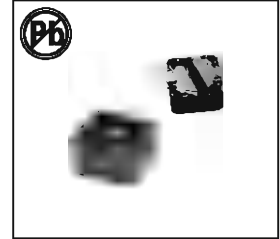

### FEATURES:

- Shielded Structure
- Flat-top for pick and place
- Low Resistance Allow high Current
- Excellent Thermal Stability
- Low profile

### APPLICATIONS:

- Ideal for a variety of DC-DC converter Inductors Applications.
- DC/DC converter
- Power supplies for portable communication equipment
- LCD, TV, PDA, PDP
- Notebook computer

### STANDARD SPECIFICATION:

Part Number	Marking	Inductance L(μH) @10KHz,0.1V	DCR(Ω)	IDC(A)
SDRH0603-3R5□	3R5	3.5	0.027	3.0
SDRH0603-4R7□	4R7	4.7	0.031	2.4
SDRH0603-6R1□	6R1	6.1	0.035	3.25
SDRH0603-7R6□	7R6	7.6	0.054	2.10
SDRH0603-100□	100	10	0.065	1.70
SDRH0603-120□	120	12	0.070	1.55
SDRH0603-150□	150	15	0.084	1.40
SDRH0603-180□	180	18	0.095	1.32
SDRH0603-220□	220	22	0.128	1.20
SDRH0603-270□	270	27	0.142	1.05
SDRH0603-330□	330	33	0.165	0.97
SDRH0603-390□	390	39	0.210	0.86
SDRH0603-470□	470	47	0.238	0.80
SDRH0603-560□	560	56	0.277	0.73
SDRH0603-680□	680	68	0.304	0.65
SDRH0603-820□	820	82	0.390	0.60
SDRH0603-101□	101	100	0.535	0.54
SDRH0603-121□	121	120	0.650	0.30
SDRH0603-151□	151	150	0.820	0.30
SDRH0603-181□	181	180	1.10	0.28
SDRH0603-221□	221	220	1.45	0.24
SDRH0603-271□	271	270	1.72	0.22
SDRH0603-331□	331	330	2.05	0.20
SDRH0603-391□	391	390	2.52	0.18
SDRH0603-471□	471	470	3.12	0.16
SDRH0603-561□	561	560	3.85	0.12
SDRH0603-681□	681	680	4.52	0.11
SDRH0603-821□	821	820	5.29	0.10
SDRH0603-102□	102	1000	7.22	0.08

□ K=10%,M=20%

### PHYSICAL CHARACTERISTICS:

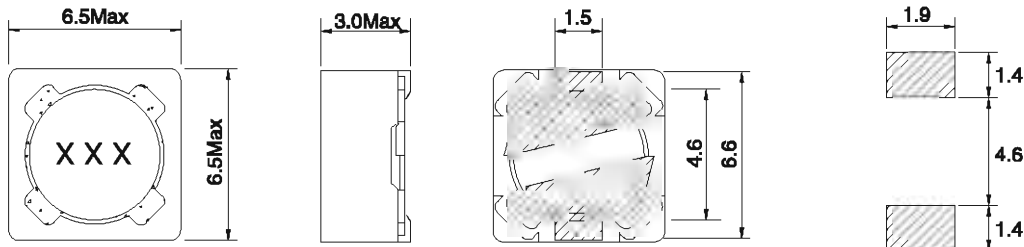

#### Test Equipment and Conditions

- ◆ Inductance is measured with HP-4284A LCR meter or equivalent.
- ◆ Maximum allowable DC current is that which causes a 25% inductance reduction of the initial value, or coil temperature to rise by 40°C, whichever is smaller. (Reference ambient temperature 20°C)
- ◆ Operating temperature: -25°C~+85°C.

# MAGNETIC SHIELDED SURFACE-MOUNT POWER INDUCTORS

## SDRH0605 SERIES

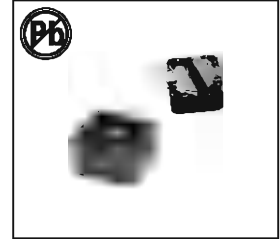

### FEATURES:

- Shielded Structure
- Flat-top for pick and place
- Low Resistance Allow high Current
- Excellent Thermal Stability
- Low profile

### APPLICATIONS:

- Ideal for a variety of DC-DC converter Inductors Applications.
- DC/DC converter
- Power supplies for portable communication equipment
- LCD, TV, PDA, PDP
- Notebook computer

### STANDARD SPECIFICATION:

Part Number	Marking	Inductance L(μH) @10KHz,0.1V	DCR(Ω)	IDC(A)
SDRH0605-100□	100	10	0.12	1.35
SDRH0605-120□	120	12	0.13	1.20
SDRH0605-150□	150	15	0.18	1.10
SDRH0605-180□	180	18	0.24	1.00
SDRH0605-220□	220	22	0.27	0.91
SDRH0605-270□	270	27	0.30	0.82
SDRH0605-330□	330	33	0.33	0.75
SDRH0605-390□	390	39	0.37	0.69
SDRH0605-470□	470	47	0.52	0.62
SDRH0605-560□	560	56	0.56	0.58
SDRH0605-680□	680	68	0.63	0.52
SDRH0605-820□	820	82	0.71	0.47
SDRH0605-101□	101	100	1.03	0.43
SDRH0605-121□	121	120	1.15	0.39
SDRH0605-151□	151	150	1.68	0.35
SDRH0605-181□	181	180	1.87	0.32
SDRH0605-221□	221	220	2.08	0.29
SDRH0605-271□	271	270	2.37	0.26
SDRH0605-331□	331	330	2.67	0.25
SDRH0605-391□	391	390	2.94	0.22
SDRH0605-471□	471	470	3.93	0.20
SDRH0605-561□	561	560	5.45	0.18
SDRH0605-681□	681	680	7.32	0.17
SDRH0605-821□	821	820	8.24	0.15
SDRH0605-102□	102	1000	9.24	0.14

□ K=10%,M=20%

### PHYSICAL CHARACTERISTICS:

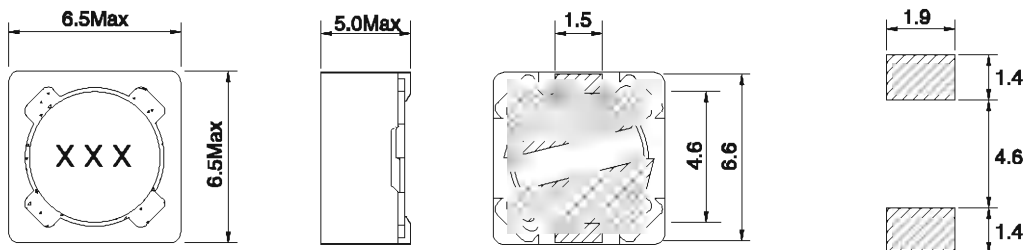

#### Test Equipment and Conditions

- ◆ Inductance is measured with HP-4284A LCR meter or equivalent.
- ◆ Maximum allowable DC current is that which causes a 25% inductance reduction of the initial value, or coil temperature to rise by 40°C, whichever is smaller. (Reference ambient temperature 20°C)
- ◆ Operating temperature: -25°C~+85°C.

# MAGNETIC SHIELDED SURFACE-MOUNT POWER INDUCTORS SDRH0703 SERIES

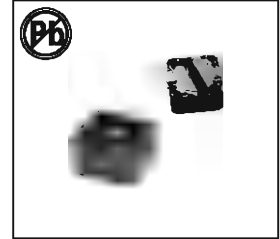

## FEATURES:

- Shielded Structure
- Flat-top for pick and place
- Low Resistance Allow high Current
- Excellent Thermal Stability
- Low profile

## APPLICATIONS:

- Ideal for a variety of DC-DC converter Inductors Applications.
- DC/DC converter
- Power supplies for portable communication equipment
- LCD, TV, PDA, PDP
- Notebook computer

## STANDARD SPECIFICATION:

Part Number	Marking	Inductance L(μH) @10kHz,0.1V	DCR(Ω)	IDC(A)
SDRH0703-100□	100	10	0.076	1.68
SDRH0703-120□	120	12	0.098	1.52
SDRH0703-150□	150	15	0.15	1.33
SDRH0703-180□	180	18	0.17	1.20
SDRH0703-220□	220	22	0.19	1.07
SDRH0703-270□	270	27	0.23	0.96
SDRH0703-330□	330	33	0.28	0.91
SDRH0703-390□	390	39	0.34	0.77
SDRH0703-470□	470	47	0.36	0.76
SDRH0703-560□	560	56	0.47	0.68
SDRH0703-680□	680	68	0.52	0.61
SDRH0703-820□	820	82	0.69	0.57
SDRH0703-101□	101	100	0.79	0.50
SDRH0703-121□	121	120	0.89	0.49
SDRH0703-151□	151	150	1.27	0.43
SDRH0703-181□	181	180	1.45	0.39
SDRH0703-221□	221	220	1.65	0.35
SDRH0703-271□	271	270	2.31	0.32
SDRH0703-331□	331	330	2.62	0.28
SDRH0703-391□	391	390	2.94	0.26
SDRH0703-471□	471	470	4.18	0.24
SDRH0703-561□	561	560	4.67	0.22
SDRH0703-681□	681	680	5.73	0.19
SDRH0703-821□	821	820	6.54	0.18
SDRH0703-102□	102	1000	9.44	0.16

□ K=10%,M=20%

## PHYSICAL CHARACTERISTICS:

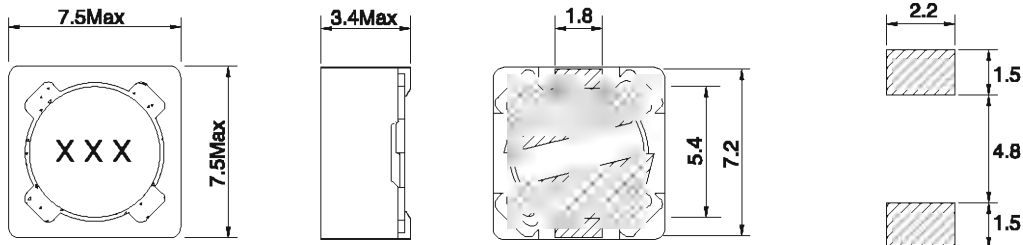

### Test Equipment and Conditions

- ◆ Inductance is measured with HP-4284A LCR meter or equivalent.
- ◆ Maximum allowable DC current is that which causes a 25% inductance reduction of the initial value, or coil temperature to rise by 40°C, whichever is smaller. (Reference ambient temperature 20°C)
- ◆ Operating temperature: -25°C~+85°C.

# MAGNETIC SHIELDED SURFACE-MOUNT POWER INDUCTORS

## SDRH0704 SERIES

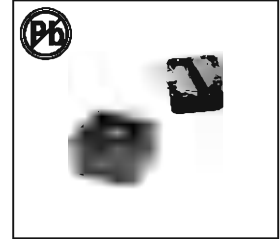

### FEATURES:

- Shielded Structure
- Flat-top for pick and place
- Low Resistance Allow high Current
- Excellent Thermal Stability
- Low profile

### APPLICATIONS:

- Ideal for a variety of DC-DC converter Inductors Applications.
- DC/DC converter
- Power supplies for portable communication equipment
- LCD, TV, PDA, PDP
- Notebook computer



Part Number	Marking	Inductance L(μH) @10kHz,0.1V	DCR(Ω)	IDC(A)
SDRH0704-100□	100	10	0.056	1.84
SDRH0704-120□	120	12	0.06	1.71
SDRH0704-150□	150	15	0.085	1.47
SDRH0704-180□	180	18	0.10	1.31
SDRH0704-220□	220	22	0.11	1.23
SDRH0704-270□	270	27	0.18	1.12
SDRH0704-330□	330	33	0.25	0.96
SDRH0704-390□	390	39	0.26	0.91
SDRH0704-470□	470	47	0.28	0.88
SDRH0704-560□	560	56	0.40	0.75
SDRH0704-680□	680	68	0.43	0.69
SDRH0704-820□	820	82	0.61	0.61
SDRH0704-101□	101	100	0.66	0.60
SDRH0704-121□	121	120	0.88	0.52
SDRH0704-151□	151	150	0.98	0.46
SDRH0704-181□	181	180	1.17	0.42
SDRH0704-221□	221	220	1.86	0.36
SDRH0704-271□	271	270	2.85	0.34
SDRH0704-331□	331	330	3.01	0.32
SDRH0704-391□	391	390	3.62	0.29
SDRH0704-471□	471	470	4.63	0.26
SDRH0704-561□	561	560	5.20	0.23
SDRH0704-681□	681	680	6.00	0.22
SDRH0704-821□	821	820	6.00	0.20
SDRH0704-102□	102	1000	6.00	0.18

□ K=10%,M=20%

### PHYSICAL CHARACTERISTICS:

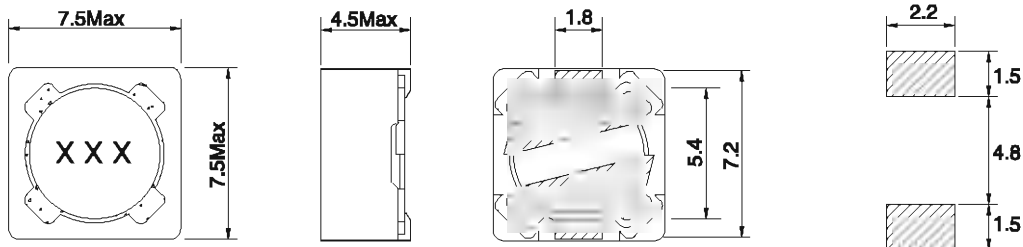

#### Test Equipment and Conditions

- ◆ Inductance is measured with HP-4284A LCR meter or equivalent.
- ◆ Maximum allowable DC current is that which causes a 25% inductance reduction of the initial value, or coil temperature to rise by 40°C, whichever is smaller. (Reference ambient temperature 20°C)
- ◆ Operating temperature: -25°C~+85°C.

# MAGNETIC SHIELDED SURFACE-MOUNT POWER INDUCTORS SDRH10145 SERIES

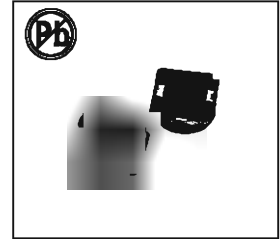

## FEATURES:

- Magnetically Shielded Structure
- Low DC Resistance
- Large current up to 3.7A
- Excellent Mechanical Strength
- High Reliability and Excellent Solderability
- Low and square Profile
- High heat resistance

## COMMON APPLICATIONS:

- VCRs, Notebook, DC/DC Converters
- Video Digital Cameras
- Communication System
- Automotive Systems Power supplier
- LCD PDP Televisions
- Hard Disk Drives, Topset, XDSL
- Network Systems
- Computer Peripheral Equipment

## ELECTRICAL CHARACTERISTICS:

Part Number	L (μH)	Test Freq (kHz)	DCR Ω Max	IDC Max A
SDRH10145-3R3□	3.3	1	0.020	3.70
SDRH10145-5R6□	5.6	1	0.027	3.20
SDRH10145-100□	10	1	0.044	2.50
SDRH10145-150□	15	1	0.057	2.20
SDRH10145-220□	22	1	0.070	1.90
SDRH10145-330□	33	1	0.100	1.70
SDRH10145-470□	47	1	0.120	1.50
SDRH10145-680□	68	1	0.168	1.30
SDRH10145-101□	100	1	0.240	1.10
SDRH10145-151□	150	1	0.420	0.81
SDRH10145-221□	220	1	0.564	0.70
SDRH10145-331□	330	1	0.816	0.58
SDRH10145-471□	470	1	1.236	0.47
SDRH10145-681□	680	1	1.920	0.38
SDRH10145-102□	1000	1	3.360	0.29
SDRH10145-122□	1200	1	3.600	0.25
SDRH10145-152□	1500	1	4.080	0.22

□:1. K= ± 10%,M= ± 20%,N= ± 30%

## TECHNICAL INFORMATION & PHYSICAL CHARACTERISTICS:

### DIMENSIONS IN:mm

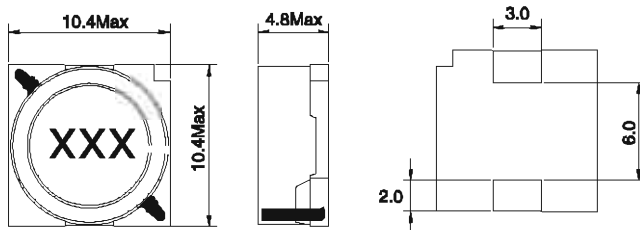

### CONSTRUCTION



### LAND PATTERNS



- Inductor Testing: HP4284A (Equivalent acceptable)  
DCR: QuadTech 1880 Milliohm meter  
Q- HP4342A - SRF-HP4191A  
IDCMax current is decreased 10% against its initial value
  - Operating temperature: -40°C to +105°C
  - Storage Temperature: -40°C to +105°C
  - Solder methods: Vapor Phase, Infrared Reflow
  - Resistance to soldering heat: 260°C for 10 seconds
  - Solvent resistance: Conforms to MIL-STD-202E
  - Marking: Inductance & Tolerance
- Note: All specifications subject to change without notice.

# MAGNETIC SHIELDED SURFACE-MOUNT POWER INDUCTORS

## SDRH103 SERIES

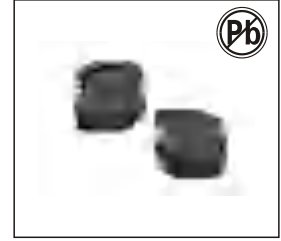

### FEATURES:

- Magnetically Shielded Structure
- Low DC Resistance
- Large current up to 2.7A
- Excellent Mechanical Strength
- High Reliability and Excellent Solderability
- Low and square Profile
- High heat resistance

### COMMON APPLICATIONS:

- VCRs, Notebook, DC/DC Converters
- Video Digital Cameras
- Communication System
- Automotive Systems Power supplier
- LCD PDP Televisions
- Hard Disk Drives, Topset, XDSL
- Network Systems
- Computer Peripheral Equipment

### ELECTRICAL CHARACTERISTICS:

Part Number	L (μH)	Test Freq (kHz)	DCR Ω Max	IDC Max A
SDRH103-100□	10	100	0.0581	2.70
SDRH103-120□	12	100	0.0721	2.25
SDRH103-150□	15	100	0.0865	2.22
SDRH103-180□	18	100	0.1161	1.90
SDRH103-220□	22	100	0.1454	1.78
SDRH103-270□	27	100	0.1759	1.63
SDRH103-330□	33	100	0.2134	1.46
SDRH103-390□	39	100	0.2689	1.32
SDRH103-470□	47	100	0.2986	1.18
SDRH103-560□	56	100	0.3358	1.10
SDRH103-680□	68	100	0.4513	1.04
SDRH103-820□	82	100	0.5138	0.94
SDRH103-101□	100	100	0.7000	0.84
SDRH103-121□	120	100	0.7650	0.76
SDRH103-151□	150	100	0.8763	0.70

□: 1. K= ± 10%, M= ± 20%, N= ± 30%

### TECHNICAL INFORMATION & PHYSICAL CHARACTERISTICS:

#### DIMENSIONS IN:mm

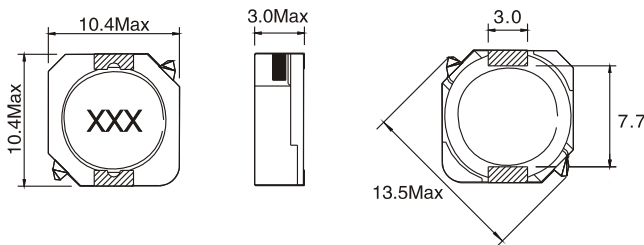

#### CONSTRUCTION



#### LAND PATTERNS

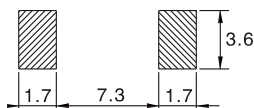

- Inductor Testing: HP4284A (Equivalent acceptable)  
DCR: QuadTech 1880 Milliohmeter  
Q- HP4342A - SRF-HP4191A  
IDCMax current is decreased 10% against its initial value
  - Operating temperature: -40°C to +105°C
  - Storage Temperature: -40°C to +105°C
  - Solder methods: Vapor Phase, Infrared Reflow
  - Resistance to soldering heat: 260°C for 10 seconds
  - Solvent resistance: Conforms to MIL-STD-202E
  - Marking: Inductance & Tolerance
- Note: All specifications subject to change without notice.

# MAGNETIC SHIELDED SURFACE-MOUNT POWER INDUCTORS

## SDRH104 SERIES

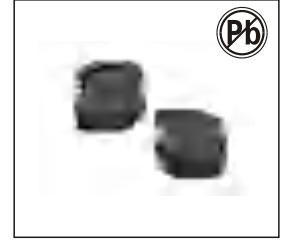

### FEATURES:

- Magnetically Shielded Structure
- Low DC Resistance
- Large current up to 10A
- Excellent Mechanical Strength
- High Reliability and Excellent Solderability
- Low and square Profile
- High heat resistance

### COMMON APPLICATIONS:

- VCRs, Notebook, DC/DC Converters
- Video Digital Cameras
- Communication System
- Automotive Systems Power supplier
- LCD PDP Televisions
- Hard Disk Drives, Topset, XDSL
- Network Systems
- Computer Peripheral Equipment

### ELECTRICAL CHARACTERISTICS:

Part Number	L (μH)	Test Freq (kHz)	DCR Ω Max	IDC Max A
SDRH104-1R3□	1.3	100	0.008	10.0
SDRH104-2R5□	2.5	100	0.010	7.50
SDRH104-3R8□	3.8	100	0.013	6.00
SDRH104-5R2□	5.2	100	0.022	5.50
SDRH104-7R0□	7.0	100	0.027	4.80
SDRH104-100□	10	100	0.035	4.40
SDRH104-150□	15	100	0.050	3.60
SDRH104-220□	22	100	0.073	2.90
SDRH104-330□	33	100	0.093	2.30
SDRH104-470□	47	100	0.128	2.10
SDRH104-680□	68	100	0.213	1.50
SDRH104-101□	100	100	0.304	1.35
SDRH104-151□	150	100	0.506	1.15
SDRH104-221□	220	100	0.756	0.92
SDRH104-331□	330	100	1.090	0.70

□: 1. K= ± 10%, M= ± 20%, N= ± 30%

### TECHNICAL INFORMATION & PHYSICAL CHARACTERISTICS:

#### DIMENSIONS IN:mm

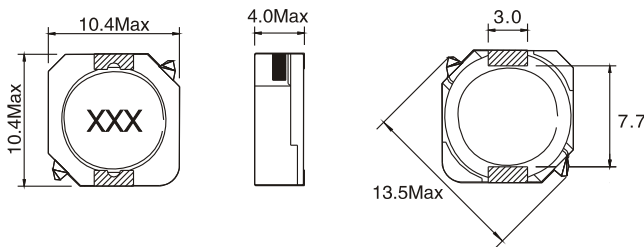

#### CONSTRUCTION



#### LAND PATTERNS

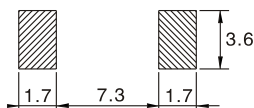

- Inductor Testing: HP4284A (Equivalent acceptable)
  - DCR: QuadTech 1880 Milliohm meter
  - Q- HP4342A - SRF-HP4191A
  - IDCMax current is decreased 10% against its initial value
  - Operating temperature: -40°C to +105°C
  - Storage Temperature: -40°C to +105°C
  - Solder methods: Vapor Phase, Infrared Reflow
  - Resistance to soldering heat: 260°C for 10 seconds
  - Solvent resistance: Conforms to MIL-STD-202E
  - Marking: Inductance & Tolerance
- Note: All specifications subject to change without notice.

# MAGNETIC SHIELDED SURFACE-MOUNT POWER INDUCTORS

## SDRH105 SERIES

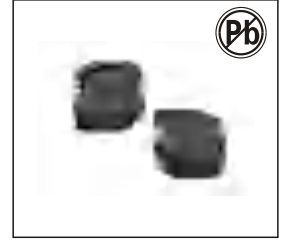

### FEATURES:

- Magnetically Shielded Structure
- Low DC Resistance
- Large current up to 3.45A
- Excellent Mechanical Strength
- High Reliability and Excellent Solderability
- Low and square Profile
- High heat resistance

### COMMON APPLICATIONS:

- VCRs, Notebook, DC/DC Converters
- Video Digital Cameras
- Communication System
- Automotive Systems Power supplier
- LCD PDP Televisions
- Hard Disk Drives, Topset, XDSL
- Network Systems
- Computer Peripheral Equipment

### ELECTRICAL CHARACTERISTICS:

Part Number	L (μH)	Test Freq (kHz)	DCR Ω Max	IDC Max A
SDRH105-100□	10	100	0.0258	3.45
SDRH105-120□	12	100	0.0320	3.40
SDRH105-150□	15	100	0.0400	2.83
SDRH105-180□	18	100	0.0460	2.62
SDRH105-220□	22	100	0.0585	2.44
SDRH105-270□	27	100	0.0654	2.24
SDRH105-330□	33	100	0.0814	1.88
SDRH105-390□	39	100	0.1031	1.70
SDRH105-470□	47	100	0.1221	1.56
SDRH105-560□	56	100	0.1448	1.39
SDRH105-680□	68	100	0.1930	1.36
SDRH105-820□	82	100	0.2194	1.20
SDRH105-101□	100	100	0.2470	1.09
SDRH105-121□	120	100	0.2984	1.00
SDRH105-151□	150	100	0.3551	0.91
SDRH105-181□	180	100	0.3943	0.84
SDRH105-221□	220	100	0.4838	0.75
SDRH105-271□	270	100	0.6325	0.68
SDRH105-331□	330	100	0.7800	0.60
SDRH105-391□	390	100	0.9575	0.57
SDRH105-471□	470	100	1.2204	0.50
SDRH105-561□	560	100	1.3524	0.47
SDRH105-681□	680	100	1.5192	0.43
SDRH105-821□	820	100	1.6944	0.39
SDRH105-102□	1000	100	1.9464	0.35

□: 1. K= ± 10%, M= ± 20%, N= ± 30%

### TECHNICAL INFORMATION & PHYSICAL CHARACTERISTICS:

#### DIMENSIONS IN:mm

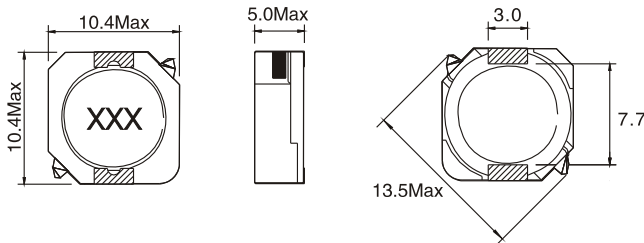

#### CONSTRUCTION



#### LAND PATTERNS

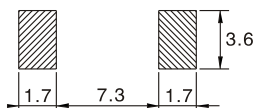

- Inductor Testing: HP4284A (Equivalent acceptable)  
DCR: QuadTech 1880 Milliohmeter  
Q- HP4342A - SRF-HP4191A  
IDCMax current is decreased 10% against its initial value
  - Operating temperature: -40°C to +105°C
  - Storage Temperature: -40°C to +105°C
  - Solder methods: Vapor Phase, Infrared Reflow
  - Resistance to soldering heat: 260°C for 10 seconds
  - Solvent resistance: Conforms to MIL-STD-202E
  - Marking: Inductance & Tolerance
- Note: All specifications subject to change without notice.

# MAGNETIC SHIELDED SURFACE-MOUNT POWER INDUCTORS

## SDRH12 SERIES

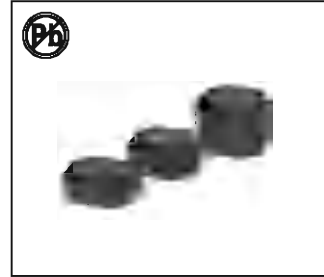

### FEATURES:

- Magnetically Shielded Structure
- Low DC Resistance
- Large current up to 12A
- Excellent Mechanical Strength
- High Reliability and Excellent Solderability
- Low and square Profile
- High heat resistance

### COMMON APPLICATIONS:

- VCRs, Notebook, DC/DC Converters
- Video Digital Cameras
- Communication System
- Automotive Systems Power supplier
- LCD PDP Televisions
- Hard Disk Drives, Topset, XDSL
- Network Systems
- Computer Peripheral Equipment

## ELECTRICAL CHARACTERISTICS@25°C

Inductance		DC Resistance(Ω) ±30%			DC saturation allowable current(A) Typ.			Temp. rise allowable current(A) Typ.		
Code	uH	SDRH1242	SDRH1257	SDRH1277	SDRH1242	SDRH1257	SDRH1277	SDRH1242	SDRH1257	SDRH1277
1R3	1.3	0.006			12.0			6.80		
2R2	2.2	0.008	0.006	0.007	9.00	11.4	11.6	5.95	6.80	6.85
3R3	3.3	0.010	0.008	0.008	7.20	9.40	10.0	5.30	5.70	6.00
4R3	4.3		0.009	0.010		8.10	9.40		5.45	5.60
4R7	4.7	0.012			6.60			4.85		
5R6	5.6		0.011	0.011		7.10	8.50		5.00	5.30
6R2	6.2	0.014			5.40			4.50		
7R5	7.5	0.016	0.012	0.013	4.90	6.20	7.40	4.20	4.70	4.80
100	10	0.021	0.017	0.014	4.50	5.60	6.30	3.60	4.00	4.30
120	12	0.026	0.022	0.016	4.00	5.00	6.00	3.30	3.70	4.15
150	15	0.029	0.026	0.019	3.80	4.40	4.90	3.10	3.30	3.85
180	18	0.038	0.029	0.021	3.10	4.00	4.60	2.70	2.95	3.70
220	22	0.045	0.033	0.024	2.80	3.70	4.30	2.50	2.65	3.25
270	27	0.056	0.043	0.030	2.55	3.20	4.00	2.20	2.55	3.00
330	33	0.065	0.053	0.035	2.25	2.95	3.25	1.95	2.30	2.85
390	39	0.084	0.056	0.046	2.10	2.75	2.85	1.75	2.20	2.50
470	47	0.10	0.069	0.051	1.82	2.50	2.65	1.65	1.95	2.30
560	56	0.12	0.08	0.062	1.75	2.30	2.50	1.44	1.80	2.10
680	68	0.14	0.10	0.077	1.65	2.05	2.40	1.35	1.60	1.90
820	82	0.16	0.13	0.09	1.48	1.85	2.35	1.23	1.40	1.80
101	100	0.20	0.14	0.11	1.33	1.65	2.20	1.15	1.30	1.60
121	120	0.23	0.18	0.13	1.24	1.50	1.90	1.02	1.20	1.40
151	150	0.29	0.23	0.18	1.05	1.35	1.60	0.92	1.05	1.20
181	180	0.35	0.26	0.19	0.98	1.20	1.45	0.82	1.00	1.15
221	220	0.45	0.32	0.24	0.93	1.10	1.35	0.73	0.88	1.05
271	270	0.55	0.38	0.31	0.82	1.00	1.25	0.66	0.81	0.91
331	330	0.67	0.47	0.34	0.70	0.90	1.00	0.59	0.70	0.88
391	390	0.82	0.54	0.40	0.65	0.80	0.90	0.52	0.67	0.80
471	470	0.92	0.66	0.51	0.58	0.75	0.80	0.48	0.61	0.70
561	560	1.10	0.79	0.56	0.54	0.70	0.73	0.45	0.54	0.65
681	680	1.37	0.95	0.73	0.51	0.65	0.68	0.40	0.50	0.60
821	820	1.67	1.15	0.87	0.45	0.55	0.62	0.36	0.44	0.55
102	1000	1.87	1.42	1.07	0.43	0.50	0.60	0.34	0.40	0.50

- Measurement frequency for inductance: 100KHz
- DC saturation allowable current: value of Inductance decrease within 30%
- Temperature rise allowable current: A rise in temperature of core surface is within 40°C
- Inductor Testing: HP4284A (Equivalent acceptable)  
DCR:QuadTech 1880 Milliohmeter Q-HP4342A – SRF-HP4191A IDCMax
- Operating temperature: -40°C to +105°C
- Storage temperature: -40°C to +105°C

Tolerance	SDRH1242	SDRH1257	SDRH1277
±30%(N)	1.3~7.5uH	2.2~7.5uH	2.2~7.5uH
±20%(M)	10~1000uH		

# SDRH12 Seires

## PHYSICAL CHARACTERISTICS & TECHNICAL INFORMATION

Dimensions(mm)

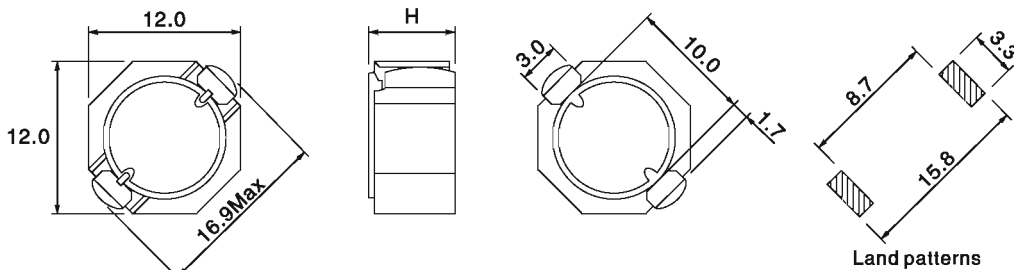

P/N	H
1242	4.5max
1257	6.0max
1277	8.0max

Land patterns

Characteristics of DC Superposition

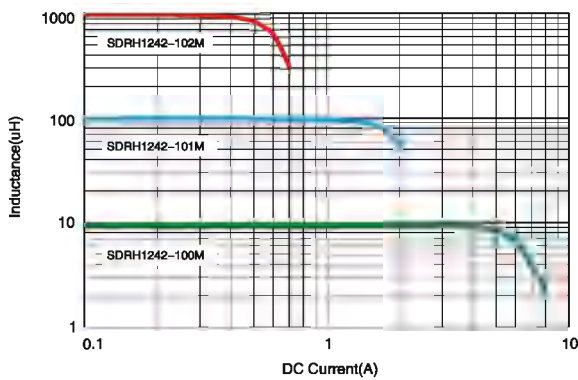

Characteristics of Temperature rise

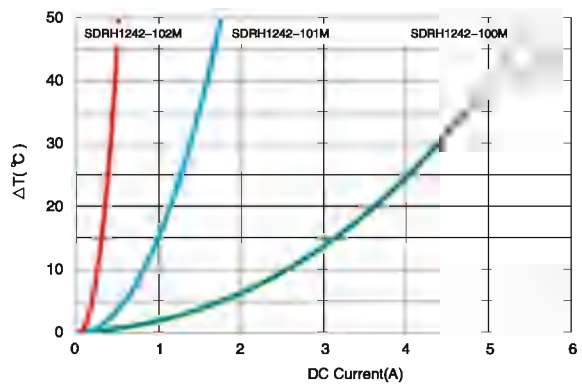

Characteristics of DC Superposition

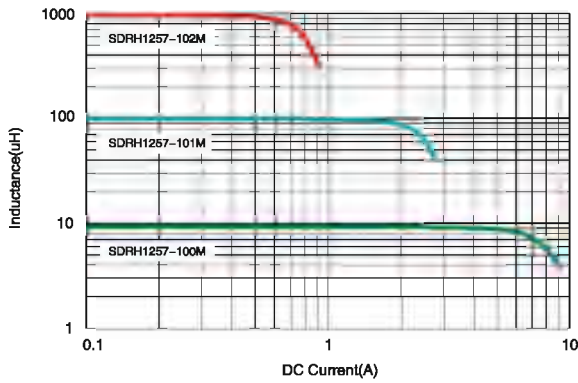

Characteristics of Temperature rise

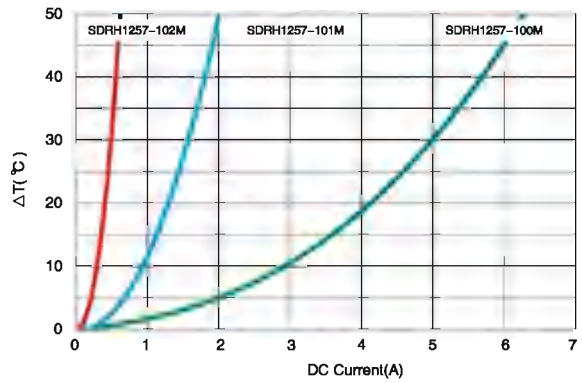

Characteristics of DC Superposition

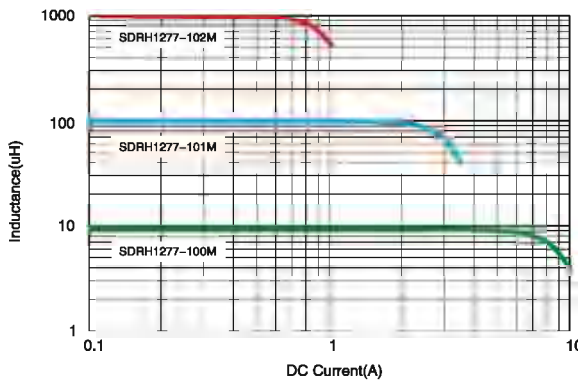

Characteristics of Temperature rise

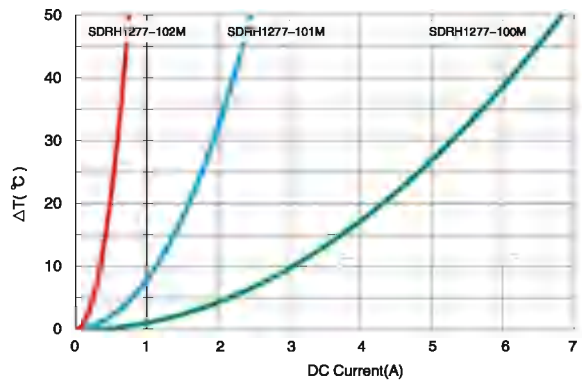

# MAGNETIC SHIELDED SURFACE-MOUNT POWER INDUCTORS SDRH1204 SERIES

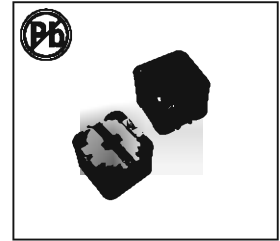

## FEATURES:

- Shielded Structure
- Flat-top for pick and place
- Low Resistance Allow high Current
- Excellent Thermal Stability
- Low profile

## APPLICATIONS:

- Ideal for a variety of DC-DC converter Inductors Applications.
- DC/DC converter
- Power supplies for portable communication equipment
- LCD, TV, PDA, PDP
- Notebook computer

## STANDARD SPECIFICATION:

Part Number	Marking	Inductance L(μH) @10KHz,0.1V	DCR(Ω)	IDC(A)
SDRH1204-100□	100	10	0.028	4.50
SDRH1204-120□	120	12	0.038	4.00
SDRH1204-150□	150	15	0.050	3.20
SDRH1204-180□	180	18	0.057	3.10
SDRH1204-220□	220	22	0.066	2.90
SDRH1204-270□	270	27	0.080	2.80
SDRH1204-330□	330	33	0.097	2.70
SDRH1204-390□	390	39	0.132	2.10
SDRH1204-470□	470	47	0.150	1.90
SDRH1204-560□	560	56	0.190	1.80
SDRH1204-680□	680	68	0.220	1.50
SDRH1204-820□	820	82	0.260	1.30
SDRH1204-101□	101	100	0.308	1.20
SDRH1204-121□	121	120	0.380	1.10
SDRH1204-151□	151	150	0.530	0.95
SDRH1204-181□	181	180	0.620	0.85
SDRH1204-221□	221	220	0.700	0.80
SDRH1204-271□	271	270	0.870	0.60
SDRH1204-331□	331	330	0.990	0.50

□ K=10%,M=20%

## PHYSICAL CHARACTERISTICS:

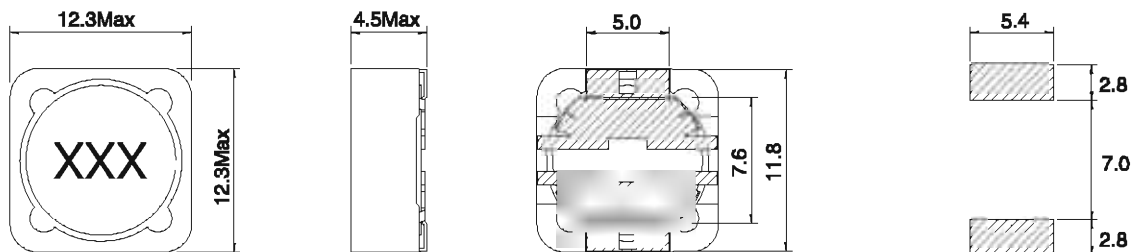

### Test Equipment and Conditions

- ◆ Inductance is measured with HP-4284A LCR meter or equivalent.
- ◆ Maximum allowable DC current is that which causes a 25% inductance reduction of the initial value, or coil temperature to rise by 40°C, whichever is smaller. (Reference ambient temperature 20°C)
- ◆ Operating temperature: -25°C~+85°C.

# MAGNETIC SHIELDED SURFACE-MOUNT POWER INDUCTORS SDRH1205 SERIES

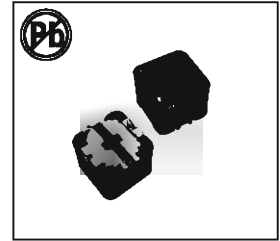

## FEATURES:

- Shielded Structure
- Flat-top for pick and place
- Low Resistance Allow high Current
- Excellent Thermal Stability
- Low profile

## APPLICATIONS:

- Ideal for a variety of DC-DC converter Inductors Applications.
- DC/DC converter
- Power supplies for portable communication equipment
- LCD, TV, PDA, PDP
- Notebook computer

## STANDARD SPECIFICATION:

Part Number	Marking	Inductance L(μH) @10kHz,0.1V	DCR(Ω)	IDC(A)
SDRH1205-100□	100	10	0.025	4.00
SDRH1205-120□	120	12	0.027	3.50
SDRH1205-150□	150	15	0.030	3.30
SDRH1205-180□	180	18	0.030	3.00
SDRH1205-220□	220	22	0.038	2.80
SDRH1205-270□	270	27	0.051	2.30
SDRH1205-330□	330	33	0.057	2.10
SDRH1205-390□	390	39	0.068	2.00
SDRH1205-470□	470	47	0.075	1.80
SDRH1205-560□	560	56	0.11	1.70
SDRH1205-680□	680	68	0.12	1.50
SDRH1205-820□	820	82	0.14	1.40
SDRH1205-101□	101	100	0.16	1.30
SDRH1205-121□	121	120	0.17	1.10
SDRH1205-151□	151	150	0.23	1.00
SDRH1205-181□	181	180	0.29	0.90
SDRH1205-221□	221	220	0.40	0.80
SDRH1205-271□	271	270	0.46	0.75
SDRH1205-331□	331	330	0.51	0.68
SDRH1205-391□	391	390	0.69	0.65
SDRH1205-471□	471	470	0.77	0.58
SDRH1205-561□	561	560	0.86	0.54
SDRH1205-681□	681	680	1.20	0.48
SDRH1205-821□	821	820	1.34	0.43
SDRH1205-102□	102	1000	1.53	0.40

□ K=10%,M=20%

## PHYSICAL CHARACTERISTICS:

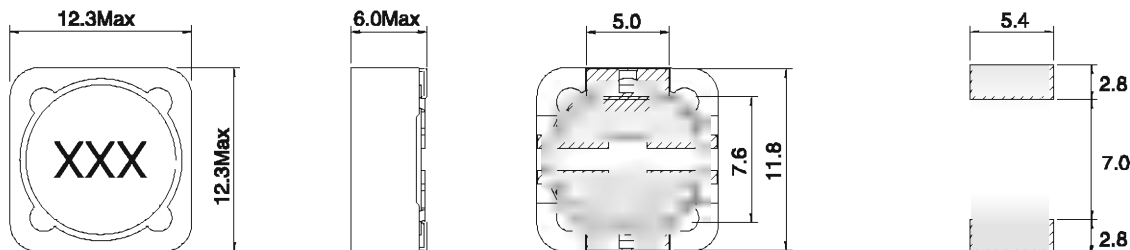

### Test Equipment and Conditions

- ◆ Inductance is measured with HP-4284A LCR meter or equivalent.
- ◆ Maximum allowable DC current is that which causes a 25% Inductance reduction of the Initial value, or coil temperature to rise by 40°C, whichever is smaller. (Reference ambient temperature 20°C)
- ◆ Operating temperature: -25°C~+85°C.

# MAGNETIC SHIELDED SURFACE-MOUNT POWER INDUCTORS

## SDRH1207 SERIES

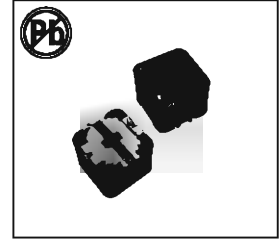

### FEATURES:

- Shielded Structure
- Flat-top for pick and place
- Low Resistance Allow high Current
- Excellent Thermal Stability
- Low profile

### APPLICATIONS:

- Ideal for a variety of DC-DC converter Inductors Applications.
- DC/DC converter
- Power supplies for portable communication equipment
- LCD, TV, PDA, PDP
- Notebook computer

### STANDARD SPECIFICATION:

Part Number	Marking	Inductance L(μH) @10kHz,0.1V	DCR(Ω)	IDC(A)
SDRH1207-1R2□	1R2	1.2	0.007	9.80
SDRH1207-2R4□	2R4	2.4	0.0115	8.00
SDRH1207-3R5□	3R5	3.5	0.0135	7.50
SDRH1207-4R7□	4R7	4.7	0.0158	6.80
SDRH1207-6R1□	6R1	6.1	0.0176	6.60
SDRH1207-7R6□	7R6	7.6	0.0200	5.90
SDRH1207-100□	100	10	0.0220	5.40
SDRH1207-120□	120	12	0.0243	4.90
SDRH1207-150□	150	15	0.0270	4.50
SDRH1207-180□	180	18	0.0392	3.90
SDRH1207-220□	220	22	0.0432	3.60
SDRH1207-270□	270	27	0.0459	3.40
SDRH1207-330□	330	33	0.0648	3.00
SDRH1207-390□	390	39	0.0729	2.75
SDRH1207-470□	470	47	0.100	2.50
SDRH1207-560□	560	56	0.110	2.35
SDRH1207-680□	680	68	0.140	2.10
SDRH1207-820□	820	82	0.160	1.95
SDRH1207-101□	101	100	0.220	1.70
SDRH1207-121□	121	120	0.250	1.60
SDRH1207-151□	151	150	0.280	1.42
SDRH1207-181□	181	180	0.350	1.30
SDRH1207-221□	221	220	0.390	1.16
SDRH1207-271□	271	270	0.560	1.08
SDRH1207-331□	331	330	0.640	0.95
SDRH1207-391□	391	390	0.700	0.88
SDRH1207-471□	471	470	0.980	0.79
SDRH1207-561□	561	560	1.070	0.73
SDRH1207-681□	681	680	1.460	0.67
SDRH1207-821□	821	820	1.640	0.60
SDRH1207-102□	102	1000	1.820	0.55

□ K=10%,M=20%

### PHYSICAL CHARACTERISTICS:

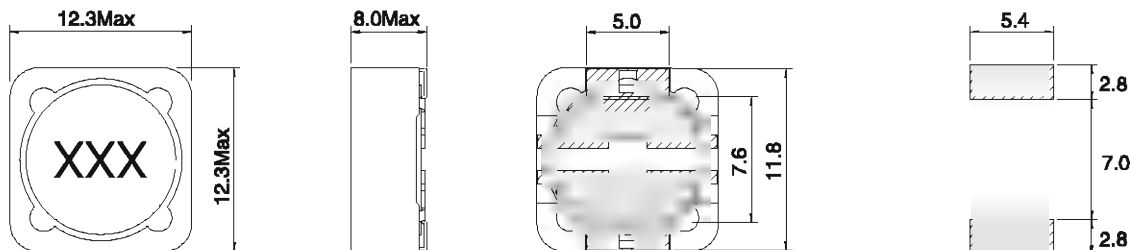

#### Test Equipment and Conditions

- ◆ Inductance is measured with HP-4284A LCR meter or equivalent.
- ◆ Maximum allowable DC current is that which causes a 25% Inductance reduction of the Initial value, or coil temperature to rise by 40°C, whichever is smaller. (Reference ambient temperature 20°C)
- ◆ Operating temperature: -25°C~+85°C.

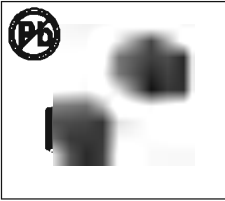

# MAGNETIC SHIELDED SURFACE-MOUNT POWER INDUCTORS

## SDRH1209 SERIES

### FEATURES:

- Shielded Structure
- Height of 10mm
- Current rating up to 11A
- RoHScompliant

### OPTIONS:

- Tape & Reel is Standard (Qty:250pcs.)
- Bulk packaging Available for Smaller Quantities
- Tolerance:K=10%,M=20% is Standard, Tighter Tolerances Available

### COMMON APPLICATIONS:

- Input/Output of DC-DC converter
- DC/DC converter
- Power supplies for: portable communication equipment
- Camcorder
- LCD,TV,PDA,PDP

### ELECTRICAL CHARACTERISTICS: 25°C

Part Number	Inductance (uH) 1KHz,0.25V	Tol. %	Q Ref.	Q Test Freq. (MHz)	SRF (MHz) Typ.	DCR Max (mΩ)	Irms (A)	Isat (A)
SDRH1209-1R0Y	1.0	±30	10	7.96	85	6.0	11.0	16.5
SDRH1209-1R8Y	1.8	±30	10	7.96	56	7.5	10.2	13.2
SDRH1209-2R2Y	2.2	±30	10	7.96	54	9.0	9.5	12.2
SDRH1209-3R3Y	3.3	±30	15	7.96	44	10	9.0	10.5
SDRH1209-4R7Y	4.7	±30	8	7.96	35	12	8.5	9.6
SDRH1209-5R6Y	5.6	±30	12	7.96	28	14	8.0	8.5
SDRH1209-6R8Y	6.8	±30	12	7.96	20	15	7.9	8.3
SDRH1209-8R2Y	8.2	±30	11	7.96	16	17	7.3	7.5
SDRH1209-100M	10	±20	16	2.52	12	18	6.5	6.5
SDRH1209-120M	12	±20	14	2.52	18	22	6.3	6.1
SDRH1209-150M	15	±20	16	2.52	10.5	32	5.8	5.3
SDRH1209-180M	18	±20	13	2.52	8.0	35	5.5	5.1
SDRH1209-220M	22	±20	16	2.52	8.0	38	5.2	4.5
SDRH1209-270M	27	±20	16	2.52	6.5	40	5.0	4.2
SDRH1209-330M	33	±20	16	2.52	6.5	52	4.4	3.7
SDRH1209-390M	39	±20	16	2.52	4.5	66	4.2	3.5
SDRH1209-470M	47	±20	16	2.52	4.5	72	3.8	3.1
SDRH1209-560M	56	±20	8	2.52	4.0	90	3.4	2.9
SDRH1209-680M	68	±20	12	2.52	3.8	102	3.0	2.7
SDRH1209-820M	82	±20	15	2.52	3.5	112	2.8	2.5
SDRH1209-101M	100	±20	16	0.796	3.0	135	2.5	2.2
SDRH1209-121M	120	±20	13	0.796	2.6	170	2.3	1.9
SDRH1209-151M	150	±20	12	0.796	2.2	190	2.2	1.8
SDRH1209-181M	180	±20	14	0.796	1.8	250	1.9	1.6
SDRH1209-221M	220	±20	15	0.796	1.8	315	1.7	1.5
SDRH1209-271M	270	±20	16	0.796	1.8	410	1.5	1.3
SDRH1209-331M	330	±20	14	0.796	1.8	450	1.4	1.2
SDRH1209-391M	390	±20	16	0.796	1.3	600	1.3	1.1
SDRH1209-471M	470	±20	12	0.796	0.85	820	1.2	1.0
SDRH1209-561M	560	±20	12	0.796	0.85	900	1.1	0.95
SDRH1209-681M	680	±20	11	0.796	0.85	1200	1.0	0.85
SDRH1209-821M	820	±20	8	0.796	0.85	1320	0.85	0.75
SDRH1209-102M	1000	±20	22	0.796	0.85	1650	0.75	0.70

Operating Temperature.....-40°C to +125°C(Temperature rise included)

Storage Temperature.....-40°C to +125°C

Resistance to Soldering Heat.....260°C for 5 sec.

Rated Current.....Inductance drop of 20 % typ. at least

Temperature Rise.....40°C typ. at Irms

# MAGNETIC SHIELDED SURFACE-MOUNT POWER INDUCTORS

## SDRH1209 SERIES

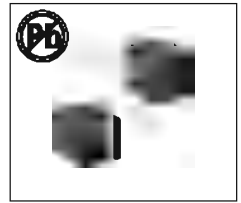

### PRODUCT DIMENSIONS:

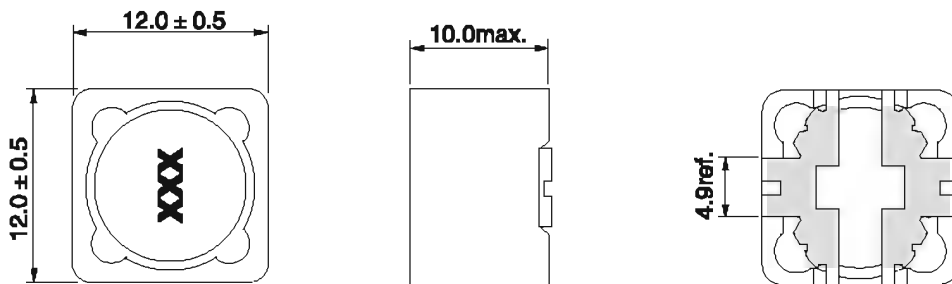

### SCHEMATIC & RECOMMENDED LAYOUT:



### CORE LOSS VS. FLUX DENSITY:

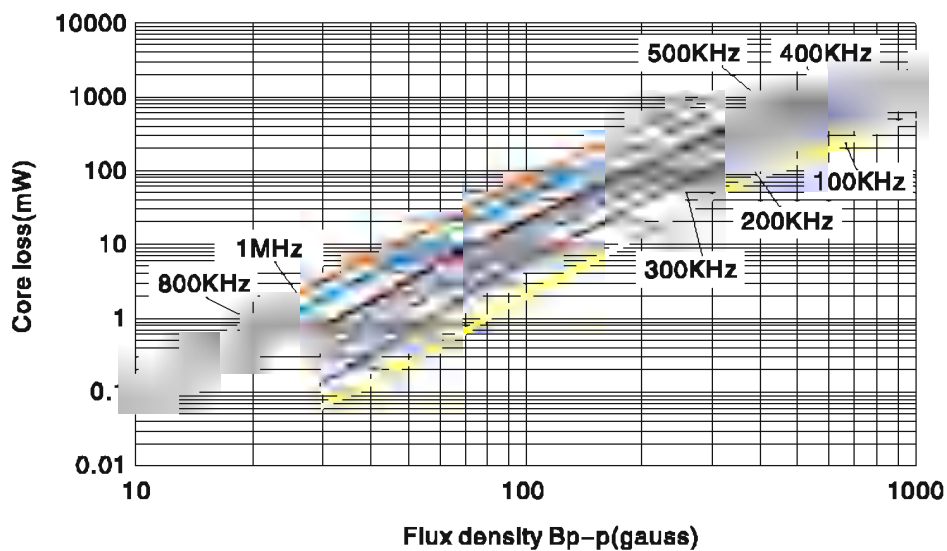

# MAGNETIC SHIELDED SURFACE-MOUNT POWER INDUCTORS SDRH12555 SERIES

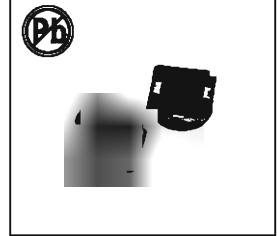

## FEATURES:

- Magnetically Shielded Structure
- Low DC Resistance
- Large current up to 3.6A
- Excellent Mechanical Strength
- High Reliability and Excellent Solderability
- Low and square Profile
- High heat resistance

## COMMON APPLICATIONS:

- VCRs, Notebook, DC/DC Converters
- Video Digital Cameras
- Communication System
- Automotive Systems Power supplier
- LCD PDP Televisions
- Hard Disk Drives, Topset, XDSL
- Network Systems
- Computer Peripheral Equipment

## ELECTRICAL CHARACTERISTICS:

Part Number	L (μH)	Test Freq (kHz)	DCR Ω Max	IDC Max A
SDRH12555-6R0□	6.0	1	0.020	3.60
SDRH12555-100□	10	1	0.026	3.40
SDRH12555-150□	15	1	0.032	2.80
SDRH12555-220□	22	1	0.041	2.30
SDRH12555-330□	33	1	0.050	1.90
SDRH12555-470□	47	1	0.075	1.60
SDRH12555-680□	68	1	0.100	1.30
SDRH12555-101□	100	1	0.150	1.10
SDRH12555-151□	150	1	0.230	0.88
SDRH12555-221□	220	1	0.330	0.72
SDRH12555-331□	330	1	0.492	0.59
SDRH12555-471□	470	1	0.624	0.49
SDRH12555-681□	680	1	0.912	0.43
SDRH12555-102□	1000	1	1.344	0.34
SDRH12555-152□	1500	1	2.076	0.29

□:1. K= ± 10%,M= ± 20%,N= ± 30%

## TECHNICAL INFORMATION & PHYSICAL CHARACTERISTICS:

### DIMENSIONS IN:mm

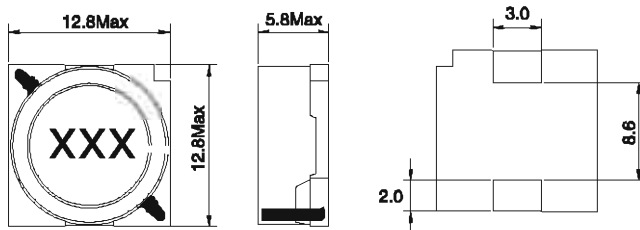

### CONSTRUCTION



### LAND PATTERNS

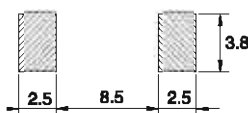

- Inductor Testing: HP4284A (Equivalent acceptable)  
DCR: QuadTech 1880 Milliohm meter  
Q- HP4342A - SRF-HP4191A  
IDCMax current is decreased 10% against its initial value
  - Operating temperature: -40°C to +105°C
  - Storage Temperature: -40°C to +105°C
  - Solder methods: Vapor Phase, Infrared Reflow
  - Resistance to soldering heat: 260°C for 10 seconds
  - Solvent resistance: Conforms to MIL-STD-202E
  - Marking: Inductance & Tolerance
- Note: All specifications subject to change without notice.

# MAGNETIC SHIELDED SURFACE-MOUNT POWER INDUCTORS

## SDRH12565 SERIES

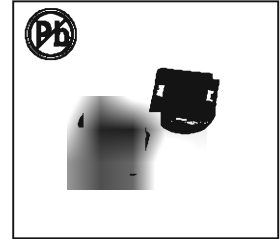

### FEATURES:

- Magnetically Shielded Structure
- Low DC Resistance
- Large current up to 6.2A
- Excellent Mechanical Strength
- High Reliability and Excellent Solderability
- Low and square Profile
- High heat resistance

### COMMON APPLICATIONS:

- VCRs, Notebook, DC/DC Converters
- Video Digital Cameras
- Communication System
- Automotive Systems Power supplier
- LCD PDP Televisions
- Hard Disk Drives, Topset, XDSL
- Network Systems
- Computer Peripheral Equipment

### ELECTRICAL CHARACTERISTICS:

Part Number	L (μH)	Test Freq (kHz)	DCR Ω Max	IDC Max A
SDRH12565-2R2□	2.2	1	0.014	6.20
SDRH12565-4R2□	4.2	1	0.018	5.50
SDRH12565-7R0□	7.0	1	0.022	5.00
SDRH12565-100□	10	1	0.025	4.80
SDRH12565-150□	15	1	0.029	4.40
SDRH12565-220□	22	1	0.038	3.80
SDRH12565-330□	33	1	0.049	3.40
SDRH12565-470□	47	1	0.070	2.80
SDRH12565-680□	68	1	0.095	2.40
SDRH12565-101□	100	1	0.150	1.90
SDRH12565-151□	150	1	0.260	1.40
SDRH12565-221□	220	1	0.330	1.20
SDRH12565-331□	330	1	0.600	0.95

□:1. K= ± 10%,M= ± 20%,N= ± 30%

### TECHNICAL INFORMATION & PHYSICAL CHARACTERISTICS:

#### DIMENSIONS IN:mm

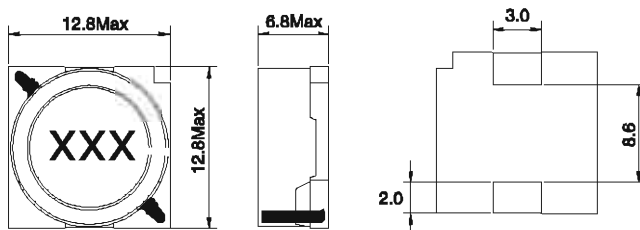

#### CONSTRUCTION



#### LAND PATTERNS

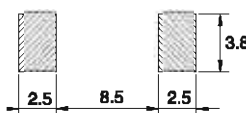

- Inductor Testing: HP4284A (Equivalent acceptable)  
DCR: QuadTech 1880 Milliohm meter  
Q- HP4342A - SRF-HP4191A  
IDCMax current is decreased 10% against its initial value
  - Operating temperature: -40°C to +105°C
  - Storage Temperature: -40°C to +105°C
  - Solder methods: Vapor Phase, Infrared Reflow
  - Resistance to soldering heat: 260°C for 10 seconds
  - Solvent resistance: Conforms to MIL-STD-202E
  - Marking: Inductance & Tolerance
- Note: All specifications subject to change without notice.

# MAGNETIC SHIELDED SURFACE-MOUNT POWER INDUCTORS SDRH12575 SERIES

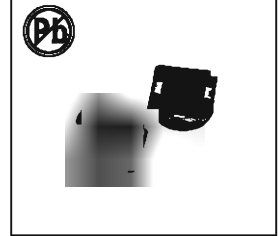

## FEATURES:

- Magnetically Shielded Structure
- Low DC Resistance
- Large current up to 8.2A
- Excellent Mechanical Strength
- High Reliability and Excellent Solderability
- Low and square Profile
- High heat resistance

## COMMON APPLICATIONS:

- VCRs, Notebook, DC/DC Converters
- Video Digital Cameras
- Communication System
- Automotive Systems Power supplier
- LCD PDP Televisions
- Hard Disk Drives, Topset, XDSL
- Network Systems
- Computer Peripheral Equipment

## ELECTRICAL CHARACTERISTICS:

Part Number	L (μH)	Test Freq (kHz)	DCR Ω Max	IDC Max A
SDRH12575-1R2□	1.2	1	0.009	8.20
SDRH12575-2R7□	2.7	1	0.012	7.00
SDRH12575-3R9□	3.9	1	0.013	6.70
SDRH12575-5R6□	5.6	1	0.014	6.30
SDRH12575-6R8□	6.8	1	0.016	5.90
SDRH12575-100□	10	1	0.019	5.40
SDRH12575-150□	15	1	0.023	5.00
SDRH12575-220□	22	1	0.032	4.00
SDRH12575-330□	33	1	0.048	3.20
SDRH12575-470□	47	1	0.064	2.70
SDRH12575-680□	68	1	0.094	2.00
SDRH12575-101□	100	1	0.150	1.90
SDRH12575-151□	150	1	0.210	1.50
SDRH12575-221□	220	1	0.310	1.30
SDRH12575-331□	330	1	0.410	1.00

□:1. K= ± 10%,M= ± 20%,N= ± 30%

## TECHNICAL INFORMATION & PHYSICAL CHARACTERISTICS:

### DIMENSIONS IN:mm

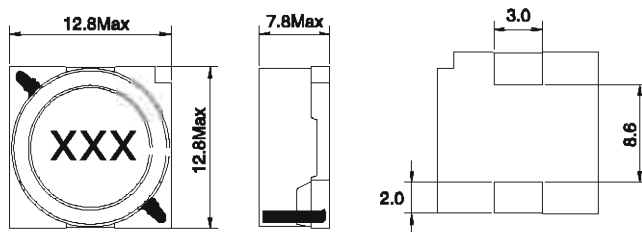

### CONSTRUCTION



### LAND PATTERNS

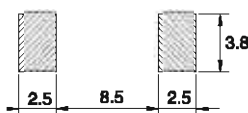

- Inductor Testing: HP4284A (Equivalent acceptable)  
DCR: QuadTech 1880 Milliohm meter  
Q- HP4342A - SRF-HP4191A  
IDCMax current is decreased 10% against its initial value
  - Operating temperature: -40°C to +105°C
  - Storage Temperature: -40°C to +105°C
  - Solder methods: Vapor Phase, Infrared Reflow
  - Resistance to soldering heat: 260°C for 10 seconds
  - Solvent resistance: Conforms to MIL-STD-202E
  - Marking: Inductance & Tolerance
- Note: All specifications subject to change without notice.

# MAGNETIC SHIELDED SURFACE-MOUNT POWER INDUCTORS

## SDRH1508 SERIES

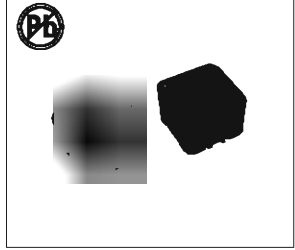

### FEATURES:

- Shielded Structure
- Flat-top for pick and place
- Low Resistance Allow high Current
- Excellent Thermal Stability
- Low profile

### COMMON APPLICATIONS:

- Ideal for a variety of DC-DC converter
- DC/DC converter
- Power supplies for:
  - portable communication equipment
- LCD, TV, PDA, PDP
- Notebook computer

### ELECTRICAL CHARACTERISTICS:

Part Number	Marking	Inductance L0(μH) ±20% @0Adc	Saturation current DC Amps Isat(A)	DCR Max. (Ω)
SDRH1508-100M	100	10	6.6	0.038
SDRH1508-150M	150	15	6.0	0.04
SDRH1508-220M	220	22	5.5	0.048
SDRH1508-330M	330	33	4.6	0.05
SDRH1508-470M	470	47	4.0	0.1
SDRH1508-680M	680	68	3.8	0.15
SDRH1508-101M	101	100	2.5	0.135
SDRH1508-221M	221	220	2.0	0.22
SDRH1508-471M	471	470	1.5	0.5
SDRH1508-102M	102	1000	0.85	1.9
SDRH1508-222M	222	2200	0.62	2.42
SDRH1508-472M	472	4700	0.44	4.0
SDRH1508-682M	682	6800	0.35	5.5

### TECHNICAL INFORMATION & PHYSICAL CHARACTERISTICS:

#### Dimensions(mm)

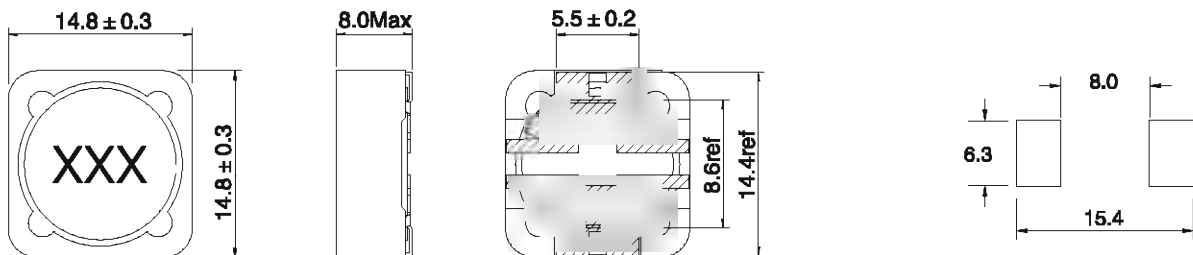

#### Winding

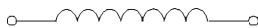

#### Notes

- Test Frequency : 100KHz / 0.1V
- Inductance is measured with HP-4284A LCR meter or equivalent.
- All test data is referenced to 25°C ambient.
- Rated current is that which causes a 20% inductance reduction of the initial value, or coil temperature to rise by 40°C, whichever is smaller.
- Operating Temperature Range -40°C to +125°C

# MAGNETIC SHIELDED SURFACE-MOUNT POWER INDUCTORS SDRH2D11 SERIES

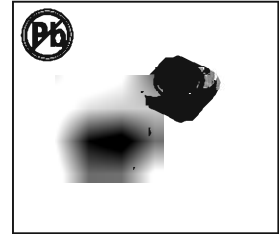

## FEATURES:

- Magnetically Shielded Structure
- Low DC Resistance
- Large current up to 0.9A
- Excellent Mechanical Strength
- High Reliability and Excellent Solderability
- Low and square Profile
- High heat resistance

## COMMON APPLICATIONS:

- VCRs, Notebook, DC/DC Converters
- Video Digital Cameras
- Communication System
- Automotive Systems Power supplier
- LCD PDP Televisions
- Hard Disk Drives, Topset, XDSL
- Network Systems
- Computer Peripheral Equipment

## ELECTRICAL CHARACTERISTICS:

Part Number	L μH	Test Freq KHz	DCR Ω Max	IDC Max A
SDRH2D11-1R5□	1.5	100	0.068	0.90
SDRH2D11-2R2□	2.2	100	0.098	0.78
SDRH2D11-3R3□	3.3	100	0.123	0.60
SDRH2D11-4R7□	4.7	100	0.170	0.50
SDRH2D11-6R8□	6.8	100	0.260	0.44
SDRH2D11-100□	10	100	0.400	0.35
SDRH2D11-220□	22	100	1.000	0.25

Note:1. K= ± 10%,M= ± 20%,N= ± 30%

## TECHNICAL INFORMATION & PHYSICAL CHARACTERISTICS:

### DIMENSIONS IN:mm

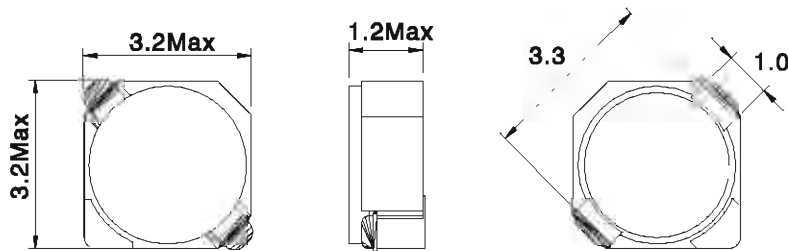

### LAND PATTERNS

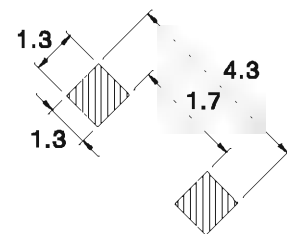

### CONSTRUCTION



- Inductor Testing: HP4284A (Equivalent acceptable)  
DCR:QuadTech 1880 Milliohmeter  
Q- HP4342A - SRF-HP4191A  
IDCMax current is decreased 10% against its initial value
  - Operating temperature: -40°C to +105°C
  - Storage Temperature: -40°C to +105°C
  - Solder methods: Vapor Phase,Infrared Reflow
  - Resistance to soldering heat:260°C for 10 seconds
  - Solvent resistance: Conforms to MIL-STD-202E
  - Marking: Inductance & Tolerance
- Note:All specifications subject to change without notice.

# MAGNETIC SHIELDED SURFACE-MOUNT POWER INDUCTORS SDRH2D18 SERIES

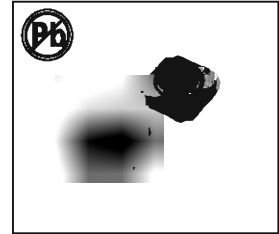

## FEATURES:

- Magnetically Shielded Structure
- Low DC Resistance
- Large current up to 0.85A
- Excellent Mechanical Strength
- High Reliability and Excellent Solderability
- Low and square Profile
- High heat resistance

## COMMON APPLICATIONS:

- VCRs, Notebook, DC/DC Converters
- Video Digital Cameras
- Communication System
- Automotive Systems Power supplier
- LCD PDP Televisions
- Hard Disk Drives, Topset, XDSL
- Network Systems
- Computer Peripheral Equipment

## ELECTRICAL CHARACTERISTICS:

Part Number	L μH	Test Freq KHz	DCR Ω Max	IDC Max A
SDRH2D18-2R2□	2.2	100	0.041	0.85
SDRH2D18-3R3□	3.3	100	0.054	0.75
SDRH2D18-4R7□	4.7	100	0.078	0.63
SDRH2D18-6R8□	6.8	100	0.106	0.52
SDRH2D18-100□	10	100	0.180	0.43
SDRH2D18-150□	15	100	0.220	0.35
SDRH2D18-220□	22	100	0.320	0.30
SDRH2D18-330□	33	100	0.460	0.24
SDRH2D18-470□	47	100	0.660	0.20

Note:1. K= ± 10%,M= ± 20%,N= ± 30%

## TECHNICAL INFORMATION & PHYSICAL CHARACTERISTICS:

### DIMENSIONS IN:mm

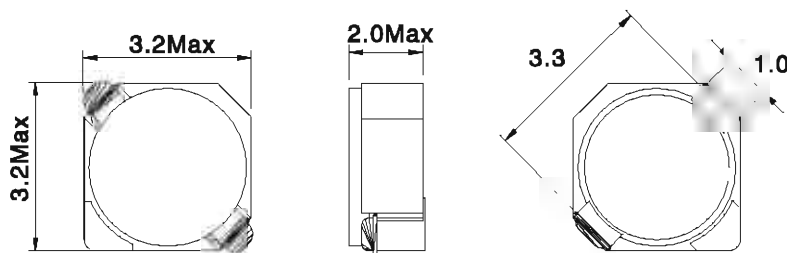

### LAND PATTERNS

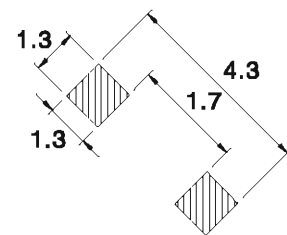

### CONSTRUCTION



- Inductor Testing: HP4284A (Equivalent acceptable)  
DCR:QuadTech 1880 Milliohmeter  
Q- HP4342A - SRF-HP4191A  
IDCMax current is decreased 10% against its initial value
  - Operating temperature: -40°C to +105°C
  - Storage Temperature: -40°C to +105°C
  - Solder methods: Vapor Phase,Infrared Reflow
  - Resistance to soldering heat:260°C for 10 seconds
  - Solvent resistance: Conforms to MIL-STD-202E
  - Marking: Inductance & Tolerance
- Note:All specifications subject to change without notice.

# MAGNETIC SHIELDED SURFACE-MOUNT POWER INDUCTORS

## SDRH3818 SERIES

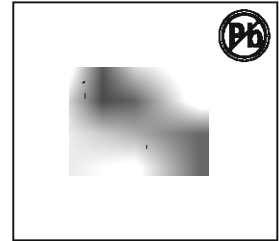

### FEATURES:

- Magnetically Shielded Structure
- Low DC Resistance
- Large current up to 1.8A
- Excellent Mechanical Strength
- High Reliability and Excellent Solderability
- Low and square Profile
- High heat resistance

### COMMON APPLICATIONS:

- VCRs, Notebook, DC/DC Converters
- Video Digital Cameras
- Communication System
- Automotive Systems Power supplier
- LCD PDP Televisions
- Hard Disk Drives, Topset, XDSL
- Network Systems
- Computer Peripheral Equipment

### ELECTRICAL CHARACTERISTICS:

Part Number	L (μH)	Test Freq (kHz)	DCR Ω Max	IDC Max A
SDRH3818-1R0□	1.0	100	0.030	1.80
SDRH3818-2R2□	2.2	100	0.058	1.50
SDRH3818-3R3□	3.3	100	0.064	1.30
SDRH3818-4R7□	4.7	100	0.146	1.10
SDRH3818-5R6□	5.6	100	0.176	0.95
SDRH3818-6R8□	6.8	100	0.238	0.90
SDRH3818-8R2□	8.2	100	0.272	0.80
SDRH3818-100□	10	1	0.299	0.70
SDRH3818-150□	15	1	0.472	0.61
SDRH3818-220□	22	1	0.592	0.52
SDRH3818-270□	27	1	0.630	0.44
SDRH3818-330□	33	1	1.075	0.43
SDRH3818-470□	47	1	1.309	0.34
SDRH3818-680□	68	1	2.613	0.25
SDRH3818-820□	82	1	2.950	0.20
SDRH3818-101□	100	1	3.255	0.19
SDRH3818-151□	150	1	3.500	0.12

□:1. K= ± 10%,M= ± 20%,N= ± 30%

### TECHNICAL INFORMATION & PHYSICAL CHARACTERISTICS:

DIMENSIONS IN:mm

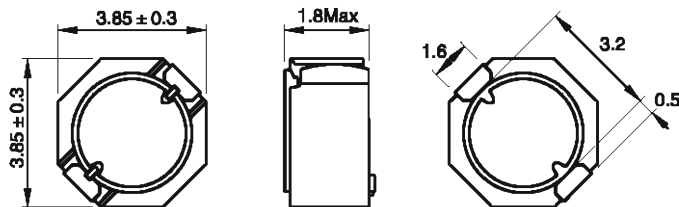

CONSTRUCTION



LAND PATTERNS

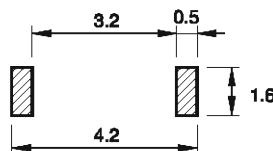

- Inductor Testing: HP4284A (Equivalent acceptable)
  - DCR:QuadTech 1880 Milliohmmer
  - Q- HP4342A - SRF-HP4191A
  - IDCMax current is decreased 10% against its initial value
  - Operating temperature: -40°C to +105°C
  - Storage Temperature: -40°C to +105°C
  - Solder methods: Vapor Phase,Infrared Reflow
  - Resistance to soldering heat:280°C for 10 seconds
  - Solvent resistance: Conforms to MIL-STD-202E
  - Marking: Inductance & Tolerance
- Note:All specifications subject to change without notice.

# MAGNETIC SHIELDED SURFACE-MOUNT POWER INDUCTORS

## SDRH3D16 SERIES

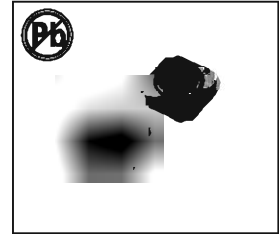

### FEATURES:

- Magnetically Shielded Structure
- Low DC Resistance
- Large current up to 1.8A
- Excellent Mechanical Strength
- High Reliability and Excellent Solderability
- Low and square Profile
- High heat resistance

### COMMON APPLICATIONS:

- VCRs, Notebook, DC/DC Converters
- Video Digital Cameras
- Communication System
- Automotive Systems Power supplier
- LCD PDP Televisions
- Hard Disk Drives, Topset, XDSL
- Network Systems
- Computer Peripheral Equipment

### ELECTRICAL CHARACTERISTICS:

Part Number	L μ H	Test Freq KHz	DCR Ω Max	IDC Max A
SDRH3D16-1R0□	1.0	100	0.048	1.80
SDRH3D16-1R5□	1.5	100	0.054	1.55
SDRH3D16-2R2□	2.2	100	0.072	1.20
SDRH3D16-3R3□	3.3	100	0.105	1.03
SDRH3D16-3R9□	3.9	100	0.118	1.02
SDRH3D16-4R7□	4.7	100	0.132	0.95
SDRH3D16-5R6□	5.6	100	0.148	0.75
SDRH3D16-6R8□	6.8	100	0.195	0.73
SDRH3D16-8R2□	8.2	100	0.250	0.65
SDRH3D16-100□	10	100	0.275	0.58
SDRH3D16-120□	12	100	0.312	0.50
SDRH3D16-150□	15	100	0.412	0.46
SDRH3D16-180□	18	100	0.462	0.43
SDRH3D16-220□	22	100	0.600	0.40
SDRH3D16-270□	27	100	0.712	0.35
SDRH3D16-330□	33	100	0.925	0.32
SDRH3D16-390□	39	100	1.062	0.28
SDRH3D16-470□	47	100	1.175	0.26

Note:1. K= ± 10%,M= ± 20%,N= ± 30%

### TECHNICAL INFORMATION & PHYSICAL CHARACTERISTICS:

#### DIMENSIONS IN:mm

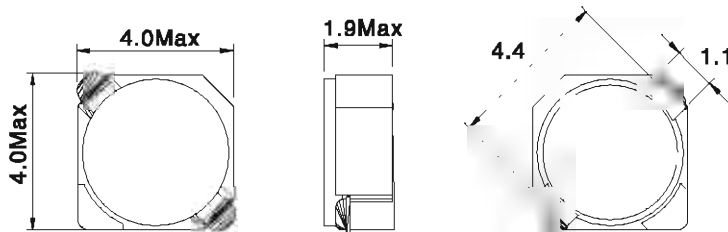

#### LAND PATTERNS

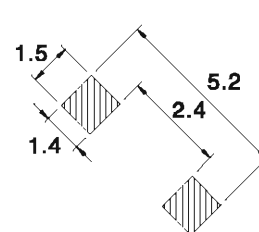

#### CONSTRUCTION



- Inductor Testing: HP4284A (Equivalent acceptable)  
DCR:QuadTech 1880 Milliohmmeter  
Q- HP4342A - SRF-HP4191A  
IDCMax current is decreased 10% against its initial value
- Operating temperature: -40°C to +105°C
- Storage Temperature: -40°C to +105°C
- Solder methods: Vapor Phase,Infrared Reflow
- Resistance to soldering heat:260°C for 10 seconds
- Solvent resistance: Conforms to MIL-STD-202E
- Marking: Inductance & Tolerance

Note:All specifications subject to change without notice.

# MAGNETIC SHIELDED SURFACE-MOUNT POWER INDUCTORS

## SDRH4D18 SERIES

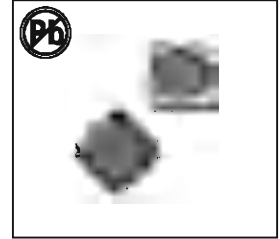

### FEATURES:

- Magnetically Shielded Structure
- Low DC Resistance
- Large current up to 1.72A
- Excellent Mechanical Strength
- High Reliability and Excellent Solderability
- Low and square Profile
- High heat resistance

### COMMON APPLICATIONS:

- VCRs, Notebook, DC/DC Converters
- Video Digital Cameras
- Communication System
- Automotive Systems Power supplier
- LCD PDP Televisions
- Hard Disk Drives, Topset, XDSL
- Network Systems
- Computer Peripheral Equipment

### ELECTRICAL CHARACTERISTICS :

Part Number	L μH	Test Freq KHz	DCR Ω Max	IDC Max A
SDRH4D18-1R0□	1.0	100	0.034	1.72
SDRH4D18-2R2□	2.2	100	0.045	1.32
SDRH4D18-2R7□	2.7	100	0.058	1.28
SDRH4D18-3R3□	3.3	100	0.070	1.04
SDRH4D18-3R9□	3.9	100	0.082	0.88
SDRH4D18-4R7□	4.7	100	0.093	0.84
SDRH4D18-5R6□	5.6	100	0.112	0.80
SDRH4D18-6R8□	6.8	100	0.140	0.76
SDRH4D18-8R2□	8.2	100	0.174	0.68
SDRH4D18-100□	10	100	0.200	0.61
SDRH4D18-120□	12	100	0.229	0.56
SDRH4D18-150□	15	100	0.261	0.50
SDRH4D18-180□	18	100	0.295	0.48
SDRH4D18-220□	22	100	0.397	0.41
SDRH4D18-270□	27	100	0.441	0.35
SDRH4D18-330□	33	100	0.525	0.32
SDRH4D18-390□	39	100	0.60	0.30
SDRH4D18-470□	47	100	0.72	0.28
SDRH4D18-560□	56	100	0.83	0.25
SDRH4D18-680□	68	100	0.97	0.23
SDRH4D18-820□	82	100	1.53	0.21
SDRH4D18-101□	100	100	1.68	0.20
SDRH4D18-121□	120	100	2.06	0.18
SDRH4D18-151□	150	100	2.58	0.17
SDRH4D18-181□	180	100	2.95	0.16
SDRH4D18-221□	220	100	4.17	0.15
SDRH4D18-271□	270	100	4.70	0.13
SDRH4D18-331□	330	100	5.37	0.12
SDRH4D18-391□	390	100	8.91	0.11

□ Note: 1. K= ± 10%, M= ± 20%, N= ± 30%

### TECHNICAL INFORMATION & PHYSICAL CHARACTERISTICS:

#### DIMENSIONS IN:mm

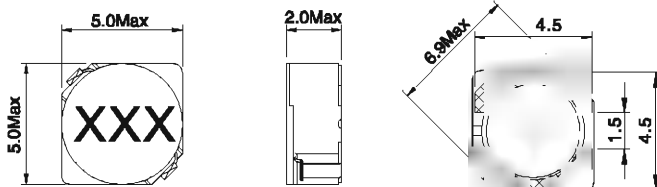

#### CONSTRUCTION



#### LAND PATTERNS

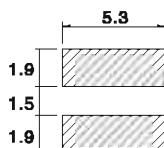

- Inductor Testing: HP4284A (Equivalent acceptable)
- DCR: QuadTech 1880 Milliohmmeter
- Q- HP4342A - SRF-HP4191A
- IDCMax current is decreased 10% against its Initial value
- Operating temperature: -40°C to +105°C
- Storage Temperature: -40°C to +105°C
- Solder methods: Vapor Phase, Infrared Reflow
- Resistance to soldering heat: 280°C for 10 seconds
- Solvent resistance: Conforms to MIL-STD-202E
- Marking: Inductance & Tolerance

Note: All specifications subject to change without notice.

# MAGNETIC SHIELDED SURFACE-MOUNT POWER INDUCTORS SDRH4D28 SERIES

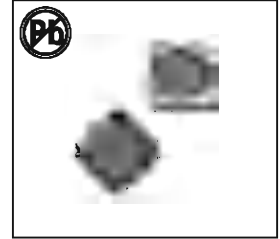

## FEATURES:

- Magnetically Shielded Structure
- Low DC Resistance
- Large current up to 2.56A
- Excellent Mechanical Strength
- High Reliability and Excellent Solderability
- Low and square Profile
- High heat resistance

## COMMON APPLICATIONS:

- VCRs, Notebook, DC/DC Converters
- Video Digital Cameras
- Communication System
- Automotive Systems Power supplier
- LCD PDP Televisions
- Hard Disk Drives, Topset, XDSL
- Network Systems
- Computer Peripheral Equipment

## ELECTRICAL CHARACTERISTICS :

Part Number	L μH	Test Freq KHz	DCR mΩ Max	IDC Max A
SDRH4D28-1R0□	1.0	100	25.3	2.56
SDRH4D28-1R5□	1.5	100	31.8	2.38
SDRH4D28-1R8□	1.8	100	36.9	2.20
SDRH4D28-2R7□	2.7	100	50.4	1.60
SDRH4D28-3R3□	3.3	100	57.6	1.57
SDRH4D28-3R9□	3.9	100	66.4	1.44
SDRH4D28-4R7□	4.7	100	72.0	1.32
SDRH4D28-5R6□	5.6	100	80.0	1.17
SDRH4D28-6R8□	6.8	100	92.0	1.12
SDRH4D28-8R2□	8.2	100	98.0	1.04
SDRH4D28-100□	10	100	103	1.00
SDRH4D28-120□	12	100	128	0.84
SDRH4D28-150□	15	100	144	0.76
SDRH4D28-180□	18	100	166	0.72
SDRH4D28-220□	22	100	218	0.70
SDRH4D28-270□	27	100	252	0.58
SDRH4D28-330□	33	100	285	0.56
SDRH4D28-390□	39	100	408	0.50
SDRH4D28-470□	47	100	440	0.48
SDRH4D28-560□	56	100	550	0.41
SDRH4D28-680□	68	100	620	0.35
SDRH4D28-820□	82	100	920	0.32
SDRH4D28-101□	100	100	1030	0.29
SDRH4D28-121□	120	100	1520	0.27
SDRH4D28-151□	150	100	1680	0.24
SDRH4D28-181□	180	100	1900	0.22

□ Note: 1. K= ± 10%, M= ± 20%, N= ± 30%

## TECHNICAL INFORMATION & PHYSICAL CHARACTERISTICS:

### DIMENSIONS IN:mm

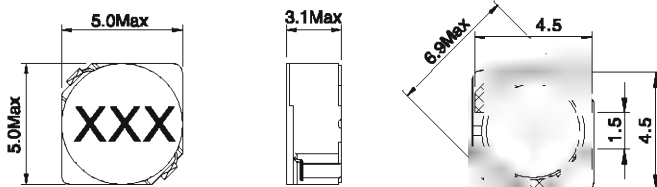

### CONSTRUCTION



### LAND PATTERNS

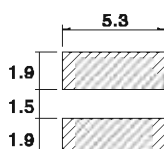

- Inductor Testing: HP4284A (Equivalent acceptable)  
DCR: QuadTech 1880 Milliohmmeter  
Q- HP4342A - SRF-HP4191A  
IDCMax current is decreased 10% against its Initial value
- Operating temperature: -40°C to +105°C
- Storage Temperature: -40°C to +105°C
- Solder methods: Vapor Phase, Infrared Reflow
- Resistance to soldering heat: 280°C for 10 seconds
- Solvent resistance: Conforms to MIL-STD-202E
- Marking: Inductance & Tolerance

Note: All specifications subject to change without notice.

# MAGNETIC SHIELDED SURFACE-MOUNT POWER INDUCTORS SDRH5018 SERIES

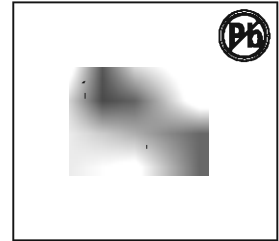

## FEATURES:

- Magnetically Shielded Structure
- Low DC Resistance
- Large current up to 1.8A
- Excellent Mechanical Strength
- High Reliability and Excellent Solderability
- Low and square Profile
- High heat resistance

## COMMON APPLICATIONS:

- VCRs, Notebook, DC/DC Converters
- Video Digital Cameras
- Communication System
- Automotive Systems Power supplier
- LCD PDP Televisions
- Hard Disk Drives, Topset, XDSL
- Network Systems
- Computer Peripheral Equipment

## ELECTRICAL CHARACTERISTICS:

Part Number	L (μH)	Test Freq (kHz)	DCR Ω Max	IDC Max A
SDRH5018-1R2□	1.2	100	0.054	1.80
SDRH5018-1R8□	1.8	100	0.065	1.60
SDRH5018-2R3□	2.3	100	0.076	1.50
SDRH5018-3R6□	3.6	100	0.097	1.20
SDRH5018-4R3□	4.3	100	0.100	1.10
SDRH5018-5R1□	5.1	100	0.130	1.00
SDRH5018-6R8□	6.8	100	0.150	0.94
SDRH5018-100□	10	100	0.220	0.80
SDRH5018-150□	15	100	0.325	0.64
SDRH5018-180□	18	100	0.380	0.56
SDRH5018-220□	22	100	0.540	0.49
SDRH5018-330□	33	100	0.770	0.41
SDRH5018-470□	47	100	1.120	0.33

□: 1. K= ± 10%, M= ± 20%, N= ± 30%

## TECHNICAL INFORMATION & PHYSICAL CHARACTERISTICS:

DIMENSIONS IN:mm

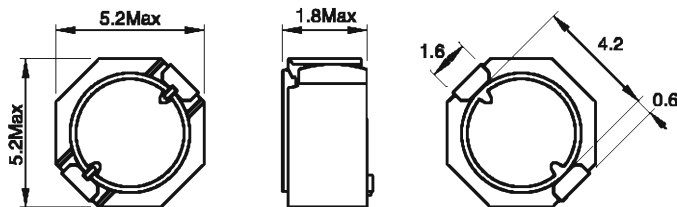

CONSTRUCTION



LAND PATTERNS

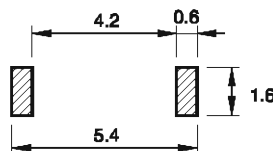

- Inductor Testing: HP4284A (Equivalent acceptable)
- DCR: QuadTech 1880 Milliohm meter
- Q- HP4342A - SRF-HP4191A
- IDCMax current is decreased 10% against its initial value
- Operating temperature: -40°C to +105°C
- Storage Temperature: -40°C to +105°C
- Solder methods: Vapor Phase, Infrared Reflow
- Resistance to soldering heat: 280°C for 10 seconds
- Solvent resistance: Conforms to MIL-STD-202E
- Marking: Inductance & Tolerance

Note: All specifications subject to change without notice.

# MAGNETIC SHIELDED SURFACE-MOUNT POWER INDUCTORS SDRH5020 SERIES

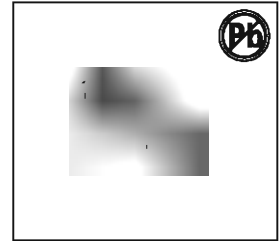

## FEATURES:

- Magnetically Shielded Structure
- Low DC Resistance
- Large current up to 2.15A
- Excellent Mechanical Strength
- High Reliability and Excellent Solderability
- Low and square Profile
- High heat resistance

## COMMON APPLICATIONS:

- VCRs, Notebook, DC/DC Converters
- Video Digital Cameras
- Communication System
- Automotive Systems Power supplier
- LCD PDP Televisions
- Hard Disk Drives, Topset, XDSL
- Network Systems
- Computer Peripheral Equipment

## ELECTRICAL CHARACTERISTICS:

Part Number	L (μH)	Test Freq (kHz)	DCR Ω Max	IDC Max A
SDRH5020-1R2□	1.2	100	0.044	2.15
SDRH5020-2R2□	2.2	100	0.059	1.63
SDRH5020-3R3□	3.3	100	0.062	1.50
SDRH5020-4R7□	4.7	100	0.087	1.14
SDRH5020-6R8□	6.8	100	0.105	0.95
SDRH5020-8R2□	8.2	100	0.139	0.90
SDRH5020-100□	10	1	0.150	0.76
SDRH5020-150□	15	1	0.210	0.63
SDRH5020-220□	22	1	0.275	0.56
SDRH5020-330□	33	1	0.455	0.44
SDRH5020-470□	47	1	0.730	0.35
SDRH5020-680□	68	1	0.935	0.30
SDRH5020-101□	100	1	1.500	0.23
SDRH5020-121□	120	1	1.910	0.22
SDRH5020-151□	150	1	2.680	0.21
SDRH5020-181□	180	1	3.040	0.20
SDRH5020-221□	220	1	3.520	0.195
SDRH5020-271□	270	1	4.380	0.193
SDRH5020-331□	330	1	5.560	0.190
SDRH5020-471□	470	1	7.820	0.180

□: 1. K= ± 10%, M= ± 20%, N= ± 30%

## TECHNICAL INFORMATION & PHYSICAL CHARACTERISTICS:

DIMENSIONS IN:mm

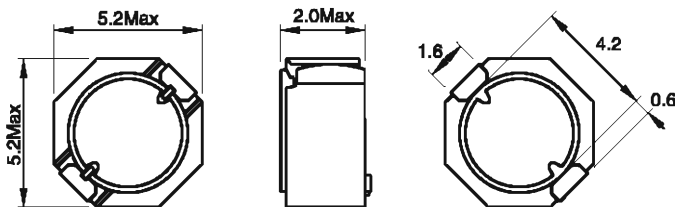

CONSTRUCTION



LAND PATTERNS

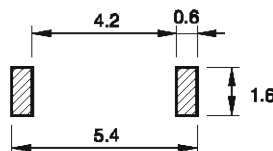

- Inductor Testing: HP4284A (Equivalent acceptable)  
DCR: QuadTech 1880 Milliohmmer  
Q- HP4342A - SRF-HP4191A  
IDCMax current is decreased 10% against its initial value
- Operating temperature: -40°C to +105°C
- Storage Temperature: -40°C to +105°C
- Solder methods: Vapor Phase, Infrared Reflow
- Resistance to soldering heat: 280°C for 10 seconds
- Solvent resistance: Conforms to MIL-STD-202E
- Marking: Inductance & Tolerance

Note: All specifications subject to change without notice.

# MAGNETIC SHIELDED SURFACE-MOUNT POWER INDUCTORS SDRH5028 SERIES

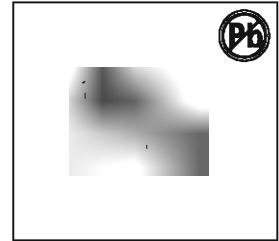

## FEATURES:

- Magnetically Shielded Structure
- Low DC Resistance
- Large current up to 4.0A
- Excellent Mechanical Strength
- High Reliability and Excellent Solderability
- Low and square Profile
- High heat resistance

## COMMON APPLICATIONS:

- VCRs, Notebook, DC/DC Converters
- Video Digital Cameras
- Communication System
- Automotive Systems Power supplier
- LCD PDP Televisions
- Hard Disk Drives, Topset, XDSL
- Network Systems
- Computer Peripheral Equipment

## ELECTRICAL CHARACTERISTICS:

Part Number	L (μH)	Test Freq (kHz)	DCR Ω Max	IDC Max A
SDRH5028-1R0□	1.0	100	0.015	4.00
SDRH5028-2R2□	2.2	100	0.029	2.41
SDRH5028-3R3□	3.3	100	0.034	2.36
SDRH5028-4R7□	4.7	100	0.045	1.87
SDRH5028-5R6□	5.6	100	0.052	1.60
SDRH5028-6R8□	6.8	100	0.068	1.51
SDRH5028-100□	10	1	0.090	1.33
SDRH5028-150□	15	1	0.142	1.05
SDRH5028-220□	22	1	0.208	0.86
SDRH5028-330□	33	1	0.257	0.72
SDRH5028-470□	47	1	0.352	0.62
SDRH5028-680□	68	1	0.525	0.51
SDRH5028-101□	100	1	0.801	0.43
SDRH5028-121□	120	1	0.850	0.34
SDRH5028-151□	150	1	1.100	0.26
SDRH5028-181□	180	1	1.190	0.24
SDRH5028-221□	220	1	1.530	0.20

□: 1. K= ± 10%, M= ± 20%, N= ± 30%

## TECHNICAL INFORMATION & PHYSICAL CHARACTERISTICS:

DIMENSIONS IN:mm

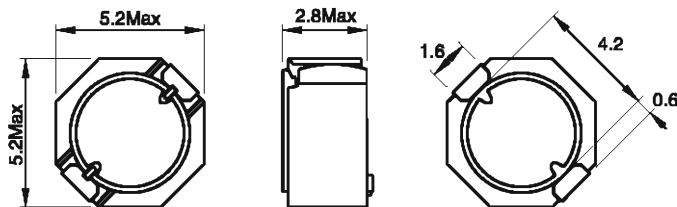

CONSTRUCTION



LAND PATTERNS

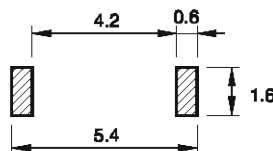

- Inductor Testing: HP4284A (Equivalent acceptable)
- DCR: QuadTech 1880 Milliohmmer
- Q- HP4342A - SRF-HP4191A
- IDCMax current is decreased 10% against its initial value
- Operating temperature: -40°C to +105°C
- Storage Temperature: -40°C to +105°C
- Solder methods: Vapor Phase, Infrared Reflow
- Resistance to soldering heat: 280°C for 10 seconds
- Solvent resistance: Conforms to MIL-STD-202E
- Marking: Inductance & Tolerance

Note: All specifications subject to change without notice.

# MAGNETIC SHIELDED SURFACE-MOUNT POWER INDUCTORS SDRH5D18 SERIES

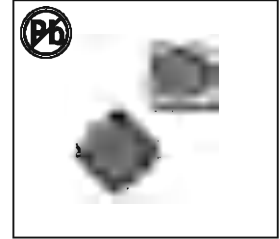

## FEATURES:

- Magnetically Shielded Structure
- Low DC Resistance
- Large current up to 3.86A
- Excellent Mechanical Strength
- High Reliability and Excellent Solderability
- Low and square Profile
- High heat resistance

## COMMON APPLICATIONS:

- VCRs, Notebook, DC/DC Converters
- Video Digital Cameras
- Communication System
- Automotive Systems Power supplier
- LCD PDP Televisions
- Hard Disk Drives, Topset, XDSL
- Network Systems
- Computer Peripheral Equipment

## ELECTRICAL CHARACTERISTICS :

Part Number	L μH	Test Freq KHz	DCR Ω Max	IDC Max A
SDRH5D18-1R0□	1.0	10	0.028	3.86
SDRH5D18-1R5□	1.5	10	0.036	3.12
SDRH5D18-2R2□	2.2	10	0.043	2.63
SDRH5D18-2R7□	2.7	10	0.051	2.38
SDRH5D18-3R5□	3.5	10	0.063	1.95
SDRH5D18-4R7□	4.7	10	0.072	1.76
SDRH5D18-5R6□	5.6	10	0.083	1.60
SDRH5D18-6R8□	6.8	10	0.102	1.40
SDRH5D18-8R2□	8.2	10	0.116	1.25
SDRH5D18-100□	10	10	0.124	1.20
SDRH5D18-120□	12	10	0.162	1.10
SDRH5D18-150□	15	10	0.204	0.97
SDRH5D18-180□	18	10	0.226	0.85
SDRH5D18-220□	22	10	0.265	0.80
SDRH5D18-270□	27	10	0.320	0.75
SDRH5D18-330□	33	10	0.380	0.65
SDRH5D18-390□	39	10	0.496	0.57
SDRH5D18-470□	47	10	0.525	0.54
SDRH5D18-560□	56	10	0.795	0.50
SDRH5D18-680□	68	10	0.860	0.43
SDRH5D18-820□	82	10	0.980	0.41
SDRH5D18-101□	100	10	1.250	0.36

□ Note: 1. K= ± 10%, M= ± 20%, N= ± 30%

## TECHNICAL INFORMATION & PHYSICAL CHARACTERISTICS:

### DIMENSIONS IN:mm

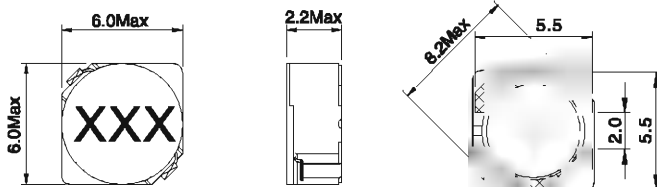

### CONSTRUCTION



### LAND PATTERNS

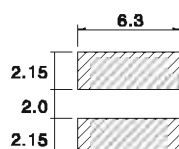

- Inductor Testing: HP4284A (Equivalent acceptable)
- DCR: QuadTech 1880 Milliohm meter
- Q- HP4342A - SRF-HP4191A
- IDCMax current is decreased 10% against its Initial value
- Operating temperature: -40°C to +105°C
- Storage Temperature: -40°C to +105°C
- Solder methods: Vapor Phase, Infrared Reflow
- Resistance to soldering heat: 280°C for 10 seconds
- Solvent resistance: Conforms to MIL-STD-202E
- Marking: Inductance & Tolerance

Note: All specifications subject to change without notice.

# MAGNETIC SHIELDED SURFACE-MOUNT POWER INDUCTORS SDRH5D28 SERIES

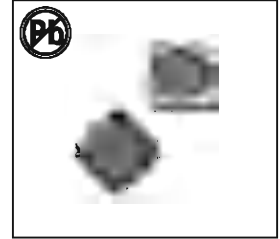

## FEATURES:

- Magnetically Shielded Structure
- Low DC Resistance
- Large current up to 2.6A
- Excellent Mechanical Strength
- High Reliability and Excellent Solderability
- Low and square Profile
- High heat resistance

## COMMON APPLICATIONS:

- VCRs, Notebook, DC/DC Converters
- Video Digital Cameras
- Communication System
- Automotive Systems Power supplier
- LCD PDP Televisions
- Hard Disk Drives, Topset, XDSL
- Network Systems
- Computer Peripheral Equipment

## ELECTRICAL CHARACTERISTICS:

Part Number	L μH	Test Freq KHz	DCR Ω Max	IDC Max A
SDRH5D28-2R5□	2.5	10	0.018	2.60
SDRH5D28-3R0□	3.0	10	0.024	2.40
SDRH5D28-4R2□	4.2	10	0.031	2.20
SDRH5D28-5R3□	5.3	10	0.038	1.90
SDRH5D28-6R2□	6.2	10	0.045	1.80
SDRH5D28-8R2□	8.2	10	0.053	1.60
SDRH5D28-100□	10	10	0.065	1.30
SDRH5D28-120□	12	10	0.076	1.20
SDRH5D28-150□	15	10	0.103	1.10
SDRH5D28-180□	18	10	0.110	1.00
SDRH5D28-220□	22	10	0.112	0.90
SDRH5D28-270□	27	10	0.175	0.85
SDRH5D28-330□	33	10	0.189	0.75
SDRH5D28-390□	39	10	0.212	0.70
SDRH5D28-470□	47	10	0.250	0.62
SDRH5D28-560□	56	10	0.305	0.58
SDRH5D28-680□	68	10	0.355	0.52
SDRH5D28-820□	82	10	0.463	0.46
SDRH5D28-101□	100	10	0.520	0.42

□: 1. K= ± 10%, M= ± 20%, N= ± 30%

## TECHNICAL INFORMATION & PHYSICAL CHARACTERISTICS:

### DIMENSIONS IN:mm

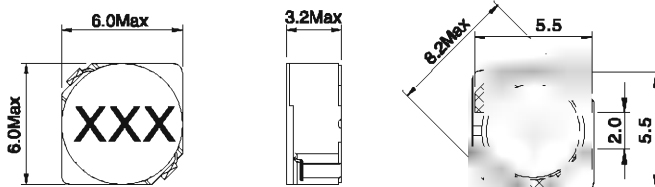

### CONSTRUCTION



### LAND PATTERNS

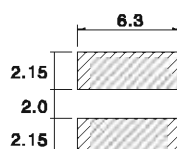

- Inductor Testing: HP4284A (Equivalent acceptable)  
DCR: QuadTech 1880 Milliohmmeter  
Q- HP4342A - SRF-HP4191A  
IDCMax current is decreased 10% against its Initial value
- Operating temperature: -40°C to +105°C
- Storage Temperature: -40°C to +105°C
- Solder methods: Vapor Phase, Infrared Reflow
- Resistance to soldering heat: 280°C for 10 seconds
- Solvent resistance: Conforms to MIL-STD-202E
- Marking: Inductance & Tolerance

Note: All specifications subject to change without notice.

# MAGNETIC SHIELDED SURFACE-MOUNT POWER INDUCTORS SDRH6025 SERIES

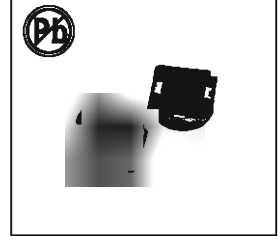

## FEATURES:

- Magnetically Shielded Structure
- Low DC Resistance
- Large current up to 2.7A
- Excellent Mechanical Strength
- High Reliability and Excellent Solderability
- Low and square Profile
- High heat resistance

## COMMON APPLICATIONS:

- VCRs, Notebook, DC/DC Converters
- Video Digital Cameras
- Communication System
- Automotive Systems Power supplier
- LCD PDP Televisions
- Hard Disk Drives, Topset, XDSL
- Network Systems
- Computer Peripheral Equipment

## ELECTRICAL CHARACTERISTICS:

Part Number	L (μH)	Test Freq (kHz)	DCR Ω Max	IDC Max A
SDRH6025-1R0□	1.0	100	0.016	2.70
SDRH6025-2R7□	2.7	100	0.022	1.80
SDRH6025-4R7□	4.7	100	0.037	1.50
SDRH6025-6R8□	6.8	100	0.054	1.30
SDRH6025-100□	10	100	0.069	1.00
SDRH6025-150□	15	100	0.102	0.88
SDRH6025-220□	22	100	0.147	0.73
SDRH6025-330□	33	100	0.216	0.59
SDRH6025-470□	47	100	0.288	0.48
SDRH6025-680□	68	100	0.444	0.42
SDRH6025-101□	100	100	0.600	0.33

□: 1. K= ± 10%, M= ± 20%, N= ± 30%

## TECHNICAL INFORMATION & PHYSICAL CHARACTERISTICS:

### DIMENSIONS IN:mm

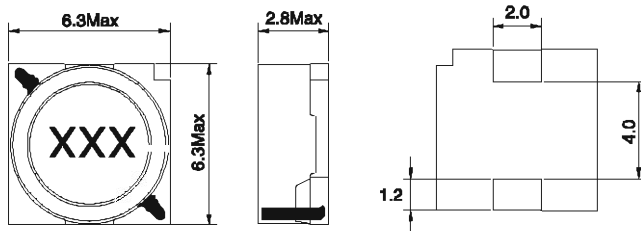

### CONSTRUCTION



### LAND PATTERNS

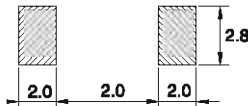

- Inductor Testing: HP4284A (Equivalent acceptable)  
DCR: QuadTech 1880 Milliohm meter  
Q- HP4342A - SRF-HP4191A  
IDCMax current is decreased 10% against its initial value
  - Operating temperature: -40°C to +105°C
  - Storage Temperature: -40°C to +105°C
  - Solder methods: Vapor Phase, Infrared Reflow
  - Resistance to soldering heat: 260°C for 10 seconds
  - Solvent resistance: Conforms to MIL-STD-202E
  - Marking: Inductance & Tolerance
- Note: All specifications subject to change without notice.

# MAGNETIC SHIELDED SURFACE-MOUNT POWER INDUCTORS SDRH6028 SERIES

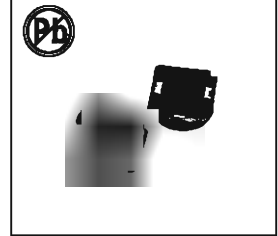

## FEATURES:

- Magnetically Shielded Structure
- Low DC Resistance
- Large current up to 1.6A
- Excellent Mechanical Strength
- High Reliability and Excellent Solderability
- Low and square Profile
- High heat resistance

## COMMON APPLICATIONS:

- VCRs, Notebook, DC/DC Converters
- Video Digital Cameras
- Communication System
- Automotive Systems Power supplier
- LCD PDP Televisions
- Hard Disk Drives, Topset, XDSL
- Network Systems
- Computer Peripheral Equipment

## ELECTRICAL CHARACTERISTICS:

Part Number	L (μH)	Test Freq (kHz)	DCR Ω Max	IDC Max A
SDRH6028-4R7□	4.7	1	0.035	1.60
SDRH6028-6R8□	6.8	1	0.043	1.50
SDRH6028-100□	10	1	0.064	1.30
SDRH6028-150□	15	1	0.090	1.00
SDRH6028-220□	22	1	0.125	0.77
SDRH6028-330□	33	1	0.178	0.69
SDRH6028-470□	47	1	0.252	0.59
SDRH6028-680□	68	1	0.348	0.50
SDRH6028-101□	100	1	0.516	0.42

□:1. K= ± 10%,M= ± 20%,N= ± 30%

## TECHNICAL INFORMATION & PHYSICAL CHARACTERISTICS:

### DIMENSIONS IN:mm

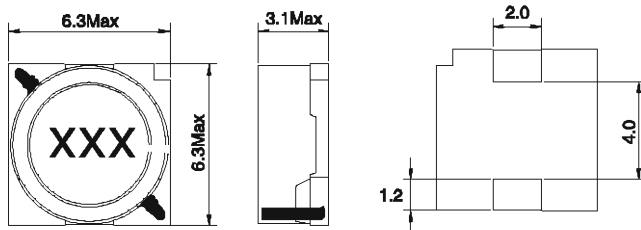

### CONSTRUCTION



### LAND PATTERNS

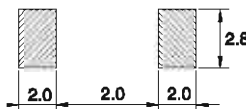

- Inductor Testing: HP4284A (Equivalent acceptable)  
DCR:QuadTech 1880 Milliohmmeter  
Q- HP4342A - SRF-HP4191A  
IDCMax current is decreased 10% against its initial value
  - Operating temperature: -40°C to +105°C
  - Storage Temperature: -40°C to +105°C
  - Solder methods: Vapor Phase,Infrared Reflow
  - Resistance to soldering heat:260°C for 10 seconds
  - Solvent resistance: Conforms to MIL-STD-202E
  - Marking: Inductance & Tolerance
- Note:All specifications subject to change without notice.

# MAGNETIC SHIELDED SURFACE-MOUNT POWER INDUCTORS SDRH6D28 SERIES

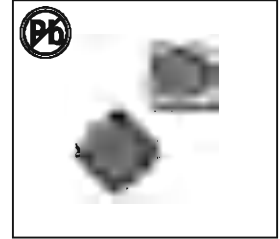

## FEATURES:

- Magnetically Shielded Structure
- Low DC Resistance
- Large current up to 3.0A
- Excellent Mechanical Strength
- High Reliability and Excellent Solderability
- Low and square Profile
- High heat resistance

## COMMON APPLICATIONS:

- VCRs, Notebook, DC/DC Converters
- Video Digital Cameras
- Communication System
- Automotive Systems Power supplier
- LCD PDP Televisions
- Hard Disk Drives, Topset, XDSL
- Network Systems
- Computer Peripheral Equipment

## ELECTRICAL CHARACTERISTICS :

Part Number	L μ H	Test Freq KHz	DCR mΩ Max	IDC Max A
SDRH6D28-3R0□	3.0	10	24	3.00
SDRH6D28-3R9□	3.9	10	27	2.60
SDRH6D28-5R0□	5.0	10	31	2.40
SDRH6D28-6R0□	6.0	10	35	2.25
SDRH6D28-7R3□	7.3	10	54	2.10
SDRH6D28-8R6□	8.6	10	58	1.85
SDRH6D28-100□	10	10	65	1.70
SDRH6D28-120□	12	10	70	1.55
SDRH6D28-150□	15	10	84	1.40
SDRH6D28-180□	18	10	95	1.32
SDRH6D28-220□	22	10	128	1.20
SDRH6D28-270□	27	10	142	1.05
SDRH6D28-330□	33	10	165	0.97
SDRH6D28-390□	39	10	210	0.86
SDRH6D28-470□	47	10	238	0.80
SDRH6D28-560□	56	10	277	0.73
SDRH6D28-680□	68	10	304	0.65
SDRH6D28-820□	82	10	390	0.60
SDRH6D28-101□	100	10	535	0.54

□:1. K= ± 10%,M= ± 20%,N= ± 30%

## TECHNICAL INFORMATION & PHYSICAL CHARACTERISTICS:

### DIMENSIONS IN:mm

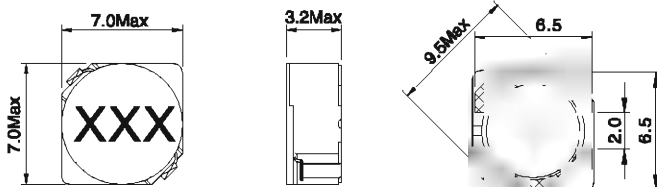

### CONSTRUCTION



### LAND PATTERNS

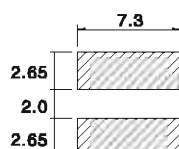

- Inductor Testing: HP4284A (Equivalent acceptable)  
DCR:QuadTech 1880 Milliohmmeter  
Q- HP4342A - SRF-HP4191A  
IDCMax current is decreased 10% against its Initial value
- Operating temperature: -40°C to +105°C
- Storage Temperature: -40°C to +105°C
- Solder methods: Vapor Phase,Infrared Reflow
- Resistance to soldering heat:280°C for 10 seconds
- Solvent resistance: Conforms to MIL-STD-202E
- Marking: Inductance & Tolerance

Note:All specifications subject to change without notice.

# MAGNETIC SHIELDED SURFACE-MOUNT POWER INDUCTORS SDRH6D38 SERIES

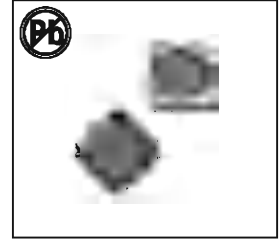

## FEATURES:

- Magnetically Shielded Structure
- Low DC Resistance
- Large current up to 3.2A
- Excellent Mechanical Strength
- High Reliability and Excellent Solderability
- Low and square Profile
- High heat resistance

## COMMON APPLICATIONS:

- VCRs, Notebook, DC/DC Converters
- Video Digital Cameras
- Communication System
- Automotive Systems Power supplier
- LCD PDP Televisions
- Hard Disk Drives, Topset, XDSL
- Network Systems
- Computer Peripheral Equipment

## ELECTRICAL CHARACTERISTICS:

Part Number	L μ H	Test Freq KHz	DCR m Ω Max	IDC Max A
SDRH6D38-3R3□	3.3	10	20	3.20
SDRH6D38-5R0□	5.0	10	24	2.60
SDRH6D38-6R2□	6.2	10	27	2.30
SDRH6D38-7R4□	7.4	10	31	2.10
SDRH6D38-8R7□	8.7	10	34	2.00
SDRH6D38-100□	10	10	44	1.80
SDRH6D38-120□	12	10	53	1.70
SDRH6D38-150□	15	10	57	1.45
SDRH6D38-180□	18	10	92	1.40
SDRH6D38-220□	22	10	96	1.20
SDRH6D38-270□	27	10	109	1.10
SDRH6D38-330□	33	10	124	1.00
SDRH6D38-390□	39	10	138	0.95
SDRH6D38-470□	47	10	155	0.85
SDRH6D38-560□	56	10	202	0.75
SDRH6D38-680□	68	10	234	0.70
SDRH6D38-820□	82	10	324	0.62
SDRH6D38-101□	100	10	358	0.58

□:1. K= ± 10%, M= ± 20%, N= ± 30%

## TECHNICAL INFORMATION & PHYSICAL CHARACTERISTICS:

### DIMENSIONS IN:mm

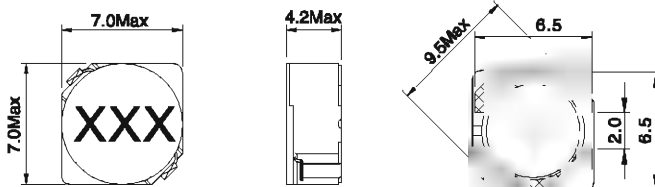

### CONSTRUCTION



### LAND PATTERNS

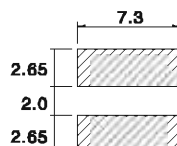

- Inductor Testing: HP4284A (Equivalent acceptable)  
DCR: QuadTech 1880 Milliohmmeter  
Q- HP4342A - SRF-HP4191A  
IDCMax current is decreased 10% against its Initial value
- Operating temperature: -40°C to +105°C
- Storage Temperature: -40°C to +105°C
- Solder methods: Vapor Phase, Infrared Reflow
- Resistance to soldering heat: 280°C for 10 seconds
- Solvent resistance: Conforms to MIL-STD-202E
- Marking: Inductance & Tolerance

Note: All specifications subject to change without notice.

# MAGNETIC SHIELDED SURFACE-MOUNT POWER INDUCTORS SDRH7028 SERIES

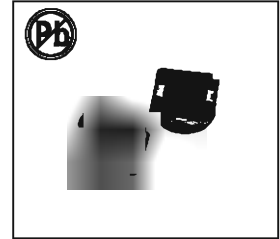

## FEATURES:

- Magnetically Shielded Structure
- Low DC Resistance
- Large current up to 1.6A
- Excellent Mechanical Strength
- High Reliability and Excellent Solderability
- Low and square Profile
- High heat resistance

## COMMON APPLICATIONS:

- VCRs, Notebook, DC/DC Converters
- Video Digital Cameras
- Communication System
- Automotive Systems Power supplier
- LCD PDP Televisions
- Hard Disk Drives, Topset, XDSL
- Network Systems
- Computer Peripheral Equipment

## ELECTRICAL CHARACTERISTICS:

Part Number	L (μH)	Test Freq (kHz)	DCR Ω Max	IDC Max A
SDRH7028-3R3□	3.3	1	0.045	1.60
SDRH7028-4R7□	4.7	1	0.054	1.50
SDRH7028-6R8□	6.8	1	0.071	1.30
SDRH7028-100□	10	1	0.100	1.10
SDRH7028-150□	15	1	0.156	0.88
SDRH7028-220□	22	1	0.216	0.75
SDRH7028-330□	33	1	0.288	0.65
SDRH7028-470□	47	1	0.408	0.54

□:1. K= ± 10%,M= ± 20%,N= ± 30%

## TECHNICAL INFORMATION & PHYSICAL CHARACTERISTICS:

### DIMENSIONS IN:mm

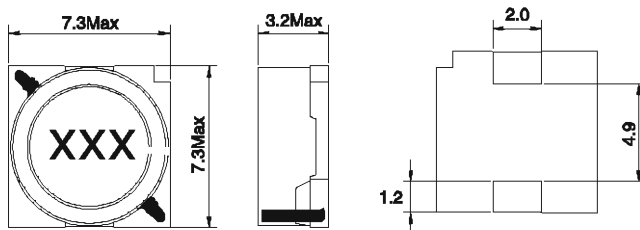

### CONSTRUCTION



### LAND PATTERNS

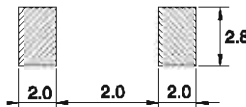

- Inductor Testing: HP4284A (Equivalent acceptable)  
DCR:QuadTech 1880 Milliohmmeter  
Q- HP4342A - SRF-HP4191A  
IDCMax current is decreased 10% against its initial value
  - Operating temperature: -40°C to +105°C
  - Storage Temperature: -40°C to +105°C
  - Solder methods: Vapor Phase,Infrared Reflow
  - Resistance to soldering heat:260°C for 10 seconds
  - Solvent resistance: Conforms to MIL-STD-202E
  - Marking: Inductance & Tolerance
- Note:All specifications subject to change without notice.

# MAGNETIC SHIELDED SURFACE-MOUNT POWER INDUCTORS SDRH7030 SERIES

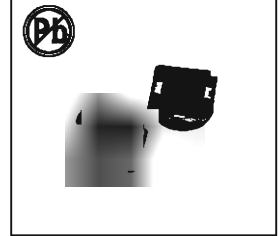

## FEATURES:

- Magnetically Shielded Structure
- Low DC Resistance
- Large current up to 1.8A
- Excellent Mechanical Strength
- High Reliability and Excellent Solderability
- Low and square Profile
- High heat resistance

## COMMON APPLICATIONS:

- VCRs, Notebook, DC/DC Converters
- Video Digital Cameras
- Communication System
- Automotive Systems Power supplier
- LCD PDP Televisions
- Hard Disk Drives, Topset, XDSL
- Network Systems
- Computer Peripheral Equipment

## ELECTRICAL CHARACTERISTICS:

Part Number	L (μH)	Test Freq (kHz)	DCR Ω Max	IDC Max A
SDRH7030-3R3□	3.3	1	0.028	1.80
SDRH7030-4R7□	4.7	1	0.044	1.60
SDRH7030-6R8□	6.8	1	0.050	1.50
SDRH7030-100□	10	1	0.064	1.30
SDRH7030-150□	15	1	0.110	1.00
SDRH7030-220□	22	1	0.132	0.86
SDRH7030-330□	33	1	0.192	0.65
SDRH7030-470□	47	1	0.288	0.57
SDRH7030-680□	68	1	0.372	0.49
SDRH7030-101□	100	1	0.540	0.35

□:1. K= ± 10%,M= ± 20%,N= ± 30%

## TECHNICAL INFORMATION & PHYSICAL CHARACTERISTICS:

### DIMENSIONS IN:mm

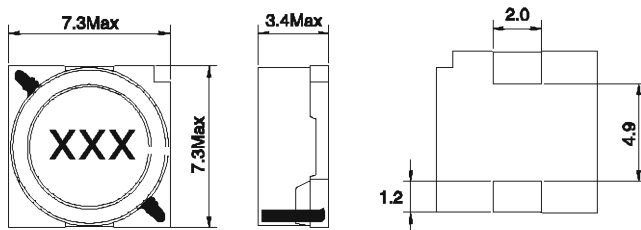

### CONSTRUCTION



### LAND PATTERNS

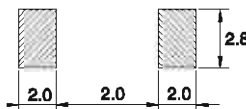

- Inductor Testing: HP4284A (Equivalent acceptable)
  - DCR: QuadTech 1880 Milliohmmer
  - Q- HP4342A - SRF-HP4191A
  - IDCMax current is decreased 10% against its initial value
  - Operating temperature: -40°C to +105°C
  - Storage Temperature: -40°C to +105°C
  - Solder methods: Vapor Phase, Infrared Reflow
  - Resistance to soldering heat: 260°C for 10 seconds
  - Solvent resistance: Conforms to MIL-STD-202E
  - Marking: Inductance & Tolerance
- Note: All specifications subject to change without notice.

# MAGNETIC SHIELDED SURFACE-MOUNT POWER INDUCTORS SDRH7032 SERIES

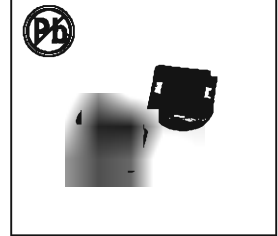

## FEATURES:

- Magnetically Shielded Structure
- Low DC Resistance
- Large current up to 1.9A
- Excellent Mechanical Strength
- High Reliability and Excellent Solderability
- Low and square Profile
- High heat resistance

## COMMON APPLICATIONS:

- VCRs, Notebook, DC/DC Converters
- Video Digital Cameras
- Communication System
- Automotive Systems Power supplier
- LCD PDP Televisions
- Hard Disk Drives, Topset, XDSL
- Network Systems
- Computer Peripheral Equipment

## ELECTRICAL CHARACTERISTICS:

Part Number	L (μH)	Test Freq (kHz)	DCR Ω Max	IDC Max A
SDRH7032-3R3□	3.3	1	0.028	1.90
SDRH7032-4R7□	4.7	1	0.044	1.70
SDRH7032-6R8□	6.8	1	0.050	1.60
SDRH7032-100□	10	1	0.064	1.40
SDRH7032-150□	15	1	0.090	1.10
SDRH7032-220□	22	1	0.132	0.96
SDRH7032-330□	33	1	0.192	0.75
SDRH7032-470□	47	1	0.288	0.67
SDRH7032-680□	68	1	0.372	0.59
SDRH7032-101□	100	1	0.542	0.45
SDRH7032-151□	150	1	0.780	0.37
SDRH7032-221□	220	1	1.260	0.29
SDRH7032-331□	330	1	2.010	0.22
SDRH7032-471□	470	1	2.460	0.20
SDRH7032-681□	680	1	3.780	0.16
SDRH7032-102□	1000	1	5.740	0.13

□:1. K=± 10%,M=± 20%,N=± 30%

## TECHNICAL INFORMATION & PHYSICAL CHARACTERISTICS:

### DIMENSIONS IN:mm

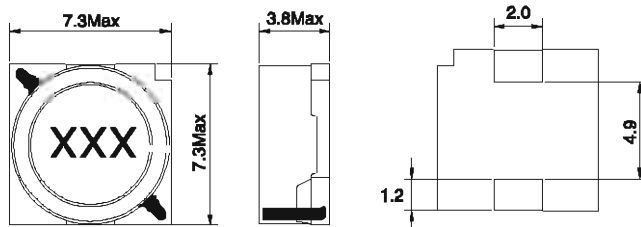

### CONSTRUCTION



### LAND PATTERNS

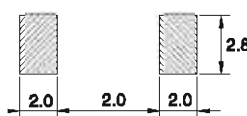

- Inductor Testing: HP4284A (Equivalent acceptable)  
DCR:QuadTech 1880 Milliohm meter  
Q- HP4342A - SRF-HP4191A  
IDCMax current is decreased 10% against its Initial value
  - Operating temperature: -40°C to +105°C
  - Storage Temperature: -40°C to +105°C
  - Solder methods: Vapor Phase, Infrared Reflow
  - Resistance to soldering heat: 260°C for 10 seconds
  - Solvent resistance: Conforms to MIL-STD-202E
  - Marking: Inductance & Tolerance
- Note: All specifications subject to change without notice.

# MAGNETIC SHIELDED SURFACE-MOUNT POWER INDUCTORS SDRH7045 SERIES

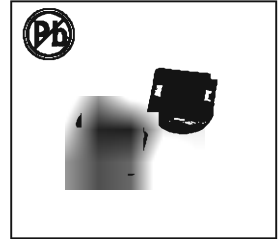

## FEATURES:

- Magnetically Shielded Structure
- Low DC Resistance
- Large current up to 2.2A
- Excellent Mechanical Strength
- High Reliability and Excellent Solderability
- Low and square Profile
- High heat resistance

## COMMON APPLICATIONS:

- VCRs, Notebook, DC/DC Converters
- Video Digital Cameras
- Communication System
- Automotive Systems Power supplier
- LCD PDP Televisions
- Hard Disk Drives, Topset, XDSL
- Network Systems
- Computer Peripheral Equipment

## ELECTRICAL CHARACTERISTICS:

Part Number	L (μH)	Test Freq (kHz)	DCR Ω Max	IDC Max A
SDRH7045-3R3□	3.3	1	0.034	2.20
SDRH7045-4R7□	4.7	1	0.038	2.10
SDRH7045-6R8□	6.8	1	0.047	1.90
SDRH7045-100□	10	1	0.057	1.80
SDRH7045-150□	15	1	0.082	1.46
SDRH7045-220□	22	1	0.099	1.25
SDRH7045-330□	33	1	0.144	1.10
SDRH7045-470□	47	1	0.216	0.90
SDRH7045-680□	68	1	0.324	0.75
SDRH7045-101□	100	1	0.468	0.60
SDRH7045-151□	150	1	0.660	0.50
SDRH7045-221□	220	1	0.996	0.40
SDRH7045-331□	330	1	1.380	0.35
SDRH7045-471□	470	1	2.160	0.31

□:1. K=± 10%,M=± 20%,N=± 30%

## TECHNICAL INFORMATION & PHYSICAL CHARACTERISTICS:

### DIMENSIONS IN:mm

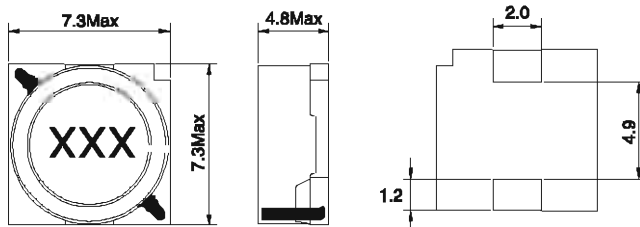

### CONSTRUCTION



### LAND PATTERNS

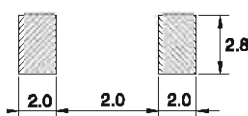

- Inductor Testing: HP4284A (Equivalent acceptable)  
DCR:QuadTech 1880 Milliohmmeter  
Q- HP4342A - SRF-HP4191A  
IDCMax current is decreased 10% against its Initial value
  - Operating temperature: -40°C to +105°C
  - Storage Temperature: -40°C to +105°C
  - Solder methods: Vapor Phase,Infrared Reflow
  - Resistance to soldering heat:260°C for 10 seconds
  - Solvent resistance: Conforms to MIL-STD-202E
  - Marking: Inductance & Tolerance
- Note:All specifications subject to change without notice.

# MAGNETIC SHIELDED SURFACE-MOUNT POWER INDUCTORS SDRH8D28 SERIES

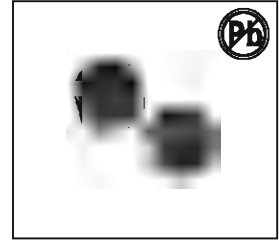

## FEATURES:

- Magnetically Shielded Structure
- Low DC Resistance
- Large current up to 5.4A
- Excellent Mechanical Strength
- High Reliability and Excellent Solderability
- Low and square Profile
- High heat resistance

## COMMON APPLICATIONS:

- VCRs, Notebook, DC/DC Converters
- Video Digital Cameras
- Communication System
- Automotive Systems Power supplier
- LCD PDP Televisions
- Hard Disk Drives, Topset, XDSL
- Network Systems
- Computer Peripheral Equipment

## ELECTRICAL CHARACTERISTICS:

Part Number	L μH	Test Freq KHz	DCR mΩ Max	IDC Max A
SDRH8D28-2R5□	2.5	100	18.5	5.4
SDRH8D28-3R3□	3.3	100	24.6	4.8
SDRH8D28-4R7□	4.7	100	36.8	4.0
SDRH8D28-6R8□	6.8	100	48.4	3.2
SDRH8D28-100□	100	100	62.2	2.7
SDRH8D28-150□	150	100	93.5	2.2
SDRH8D28-220□	220	100	156.6	1.8
SDRH8D28-330□	330	100	205.2	1.4
SDRH8D28-470□	470	100	266.1	1.25
SDRH8D28-680□	680	100	368.5	0.96
SDRH8D28-101□	101	100	610.8	0.78

□:1. K= ± 10%,M= ± 20%,N= ± 30%

## TECHNICAL INFORMATION & PHYSICAL CHARACTERISTICS:

DIMENSIONS IN:mm

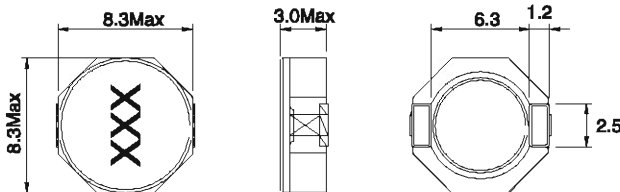

CONSTRUCTION



LAND PATTERNS

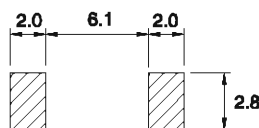

- Inductor Testing: HP4284A (Equivalent acceptable)
- DCR:QuadTech 1880 Milliohmeter
- Q- HP4342A - SRF-HP4181A
- IDCMax current is decreased 10% against its initial value
- Operating temperature: -40°C to +105°C
- Storage Temperature: -40°C to +105°C
- Solder methods: Vapor Phase,Infrared Reflow
- Resistance to soldering heat:260°C for 10 seconds
- Solvent resistance: Conforms to MIL-STD-202E
- Marking: Inductance & Tolerance
- Note:All specifications subject to change without notice.

# MAGNETIC SHIELDED SURFACE-MOUNT POWER INDUCTORS

## SDRH8D43 SERIES

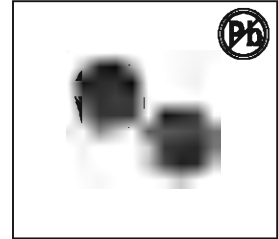

### FEATURES:

- Magnetically Shielded Structure
- Low DC Resistance
- Large current up to 6.4A
- Excellent Mechanical Strength
- High Reliability and Excellent Solderability
- Low and square Profile
- High heat resistance

### COMMON APPLICATIONS:

- VCRs, Notebook, DC/DC Converters
- Video Digital Cameras
- Communication System
- Automotive Systems Power supplier
- LCD PDP Televisions
- Hard Disk Drives, Topset, XDSL
- Network Systems
- Computer Peripheral Equipment

### ELECTRICAL CHARACTERISTICS:

Part Number	L μH	Test Freq KHz	DCR mΩ Max	IDC Max A
SDRH8D43-2R0□	2.0	100	14	6.4
SDRH8D43-3R9□	3.9	100	19	5.0
SDRH8D43-4R7□	4.7	100	22	4.6
SDRH8D43-6R8□	6.8	100	32	4.2
SDRH8D43-100□	10	100	40	3.6
SDRH8D43-150□	15	100	58	2.6
SDRH8D43-220□	22	100	96	2.1
SDRH8D43-330□	33	100	144	1.6
SDRH8D43-470□	47	100	195	1.4
SDRH8D43-680□	68	100	240	1.2
SDRH8D43-101□	100	100	360	0.9

□:1. K= ± 10%,M= ± 20%,N= ± 30%

### TECHNICAL INFORMATION & PHYSICAL CHARACTERISTICS:

DIMENSIONS IN:mm

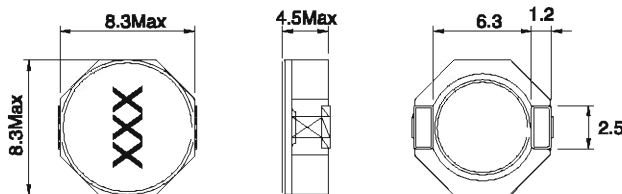

CONSTRUCTION



LAND PATTERNS

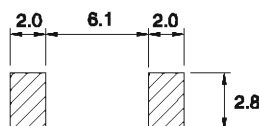

- Inductor Testing: HP4284A (Equivalent acceptable)
- DCR:QuadTech 1880 Milliohmmer
- Q- HP4342A - SRF-HP4181A
- IDCMax current is decreased 10% against its initial value
- Operating temperature: -40°C to +105°C
- Storage Temperature: -40°C to +105°C
- Solder methods: Vapor Phase,Infrared Reflow
- Resistance to soldering heat:260°C for 10 seconds
- Solvent resistance: Conforms to MIL-STD-202E
- Marking: Inductance & Tolerance
- Note:All specifications subject to change without notice.

# SMT POWER INDUCTOR SMB0808B SERIES



## FEATURES:

- SMD inductors
- High current and lower DCR
- Ferrite core material
- Shielded construction
- Operating Temperature: -40°C to +125°C

## APPLICATIONS:

- Servers
- Multi-phase and Vcore regulators
- Notebook regulators
- Battery power systems
- Graphics cards

## ELECTRICAL CHARACTERISTICS:

Part No.	Marking	OCL (nH) ± 10%	DCR (mΩ) ± 15%	I <sub>rms</sub> (A) @ 25°C	I <sub>sat1</sub> (A) @ 25°C
SMB0808B-R30K	R30	300	0.8	28	60
SMB0808B-R40K	R40	400	0.8	28	45
SMB0808B-R47K	R47	470	0.8	28	36
SMB0808B-R60K	R60	600	0.8	28	29
SMB0808B-R80K	R80	800	0.8	28	22
SMB0808B-1R0K	1R0	1000	0.8	28	15

1. Open Circuit Inductance (OCL) test condition: 100KHz, 1V<sub>rms</sub>, 0A<sub>dc</sub> ,at 25°C
2. I<sub>rms</sub>: DC current for an approximate temperature rise of 40 °C without coreloss. Derating is necessary for AC currents. PCB layout, trace thickness andwidth, air-flow, and proximity of other heat generating components will affect the temperature rise. It is recommended that the temperature of the part not exceed +125 ° C under worst case operating conditions verified in the end application.
3. I<sub>sat</sub> : Peak current for approximately 20% rolloff @ +25 °C
4. Marking: Denotes inductance
5. Tolerance: OCL Tolerance: K= ± 10% / L= ± 15% / M= ± 20% Measurement Equipment: WK3260B+WK3265B (or equivalent)

## TECHNICAL INFORMATION & PHYSICAL CHARACTERISTICS

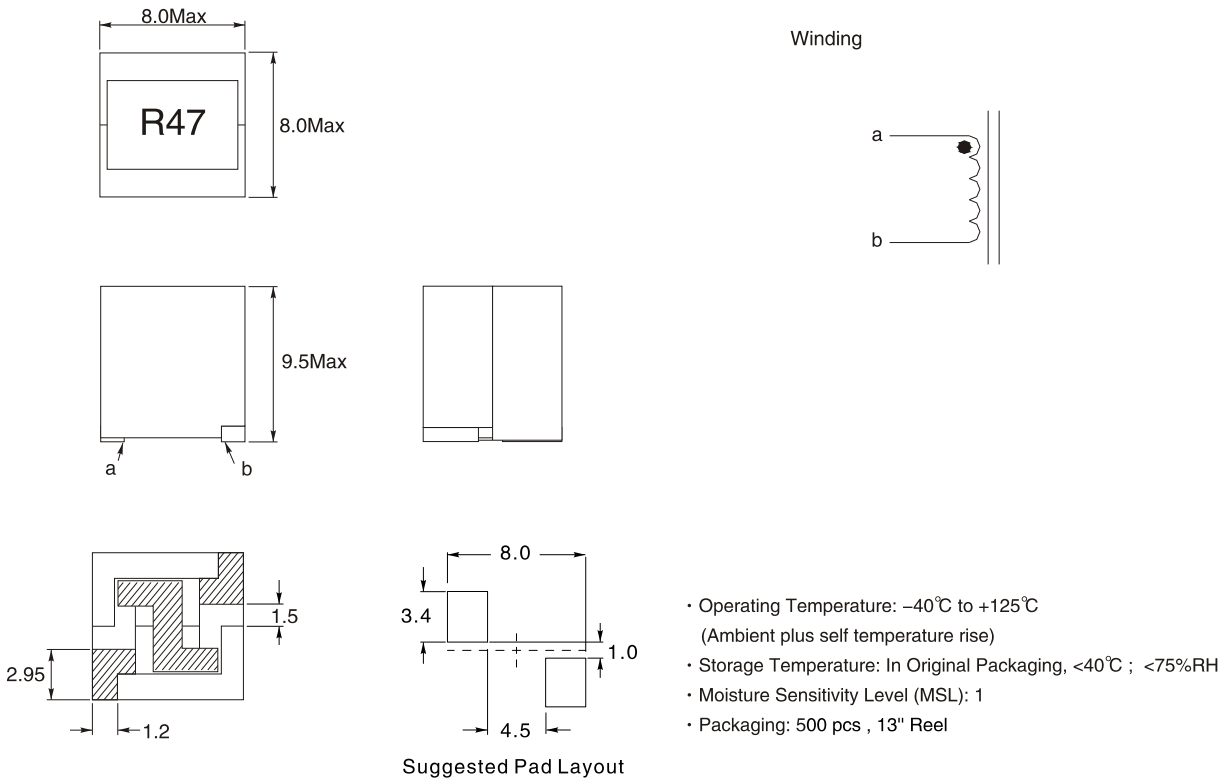

**CURRENT VS INDUCTANCE & TEMPERATURE RISE:**

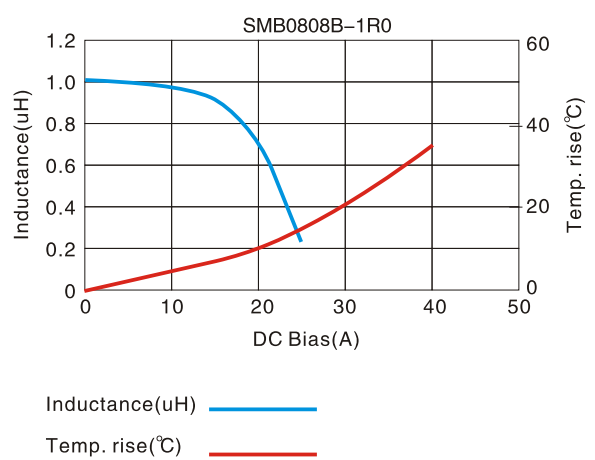
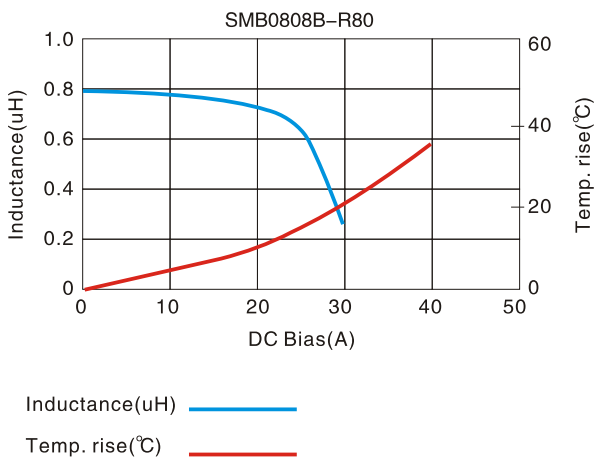
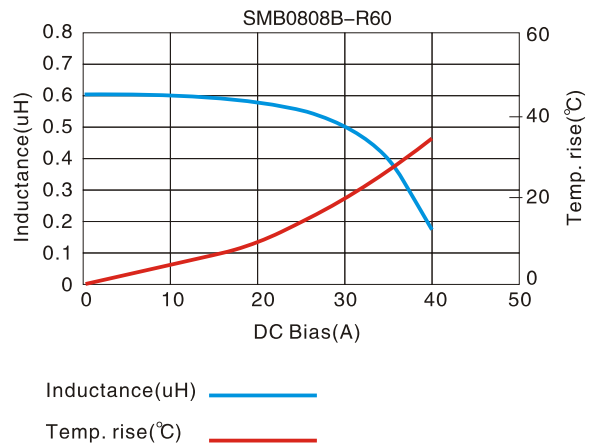
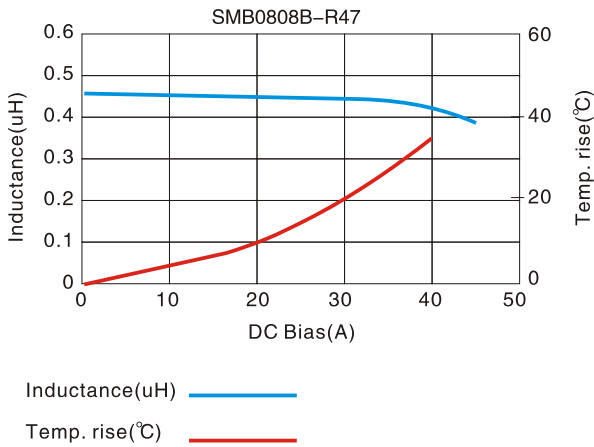
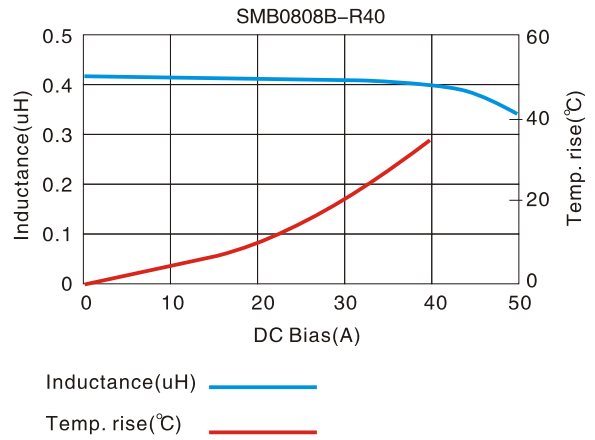
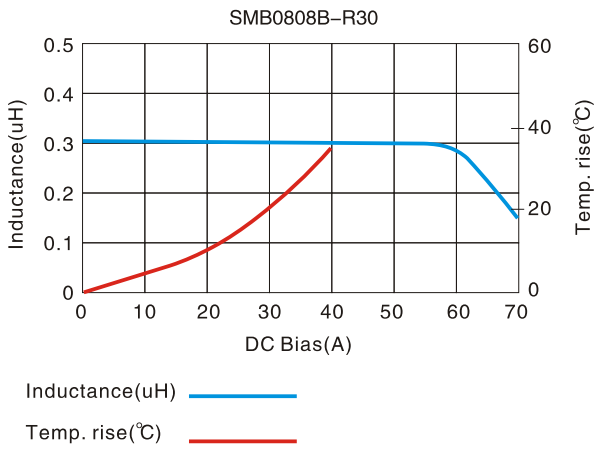

# SMT POWER INDUCTOR

## SMB1007B SERIES



### FEATURES:

- Ferrite based SMT inductor with lower core loss.
- Inductance Range: 330.0nH to 1600.0nH, Custom values are welcomed.
- High current output chokes, up to 65.0 Amp with approx. 20% roll off.
- 10.00 mm Max. height.
- Perfect for high density designs with limited board space.
- Operating frequency up to 5.0 MHz application.
- Operating Temperature Range -55°C to + 130°C , RoHs & HF compliance .
- T & R Qty: 400 pcs , 13" Reel ;

### ELECTRICAL CHARACTERISTICS :

Part No.	OCL (nH) ± 15%	L@Isat1 (nH) Min	DCR (mΩ) ± 10%	Isat1 (A) @ 25°C	Isat2 (A) @ 75°C	Isat3 (A) @ 100°C	Irms (A) @ 25°C	Dim. B Max
SMB1007B-R33L	330	231	0.81	65	58	53	30	7.3
SMB1007B-R47L	470	329	0.81	48	40	38	30	7.0
SMB1007B-R68L	680	476	0.81	34	31	29	30	7.0
SMB1007B-R82L	820	574	0.81	28	25	23	30	7.0
SMB1007B-1R0L	1000	700	0.81	23	19	18	30	7.0
SMB1007B-1R2L	1200	840	0.81	20	17	15	30	7.0
SMB1007B-1R4L	1400	980	0.81	16	14	13	30	7.0
SMB1007B-1R6L	1600	1120	0.81	14	13	12	30	7.0

1. Open Circuit Inductance (OCL) test condition:100KHz,0.1Vrms,0Adc ,at 25°C
2. L @ Isat and L @ I rms Test condition:100KHz,0.1Vrms(Ta=25°C)
3. The nominal DCR is measured from point "a" to point "b", as shown above on the mechanical drawing (Ta=25°C)
4. Isat1,Isat2 , & Isat3 : DC current that will cause inductance to drop approximately by 20%.
5. I rms: DC current for an approximate temperature rise of 40°C without core loss , Derating is necessary for AC currents. PCB pad layout , trace thickness and width , air-flow and proximity of other heat generating components will affect the temperature rise. It is recommended the part temperature not exceed 130°C under worst case operating conditions verified in the end application.

### TECHNICAL INFORMATION & PHYSICAL CHARACTERISTICS

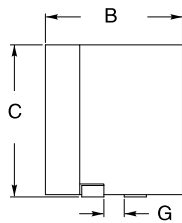
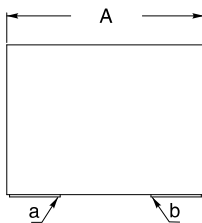

Winding

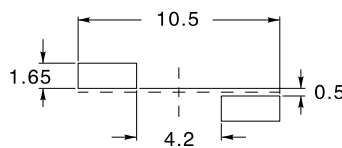
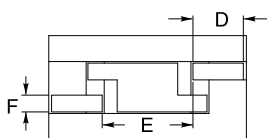
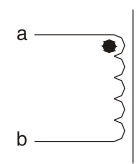

Suggested Pad Layout

Mechanical Dimension(Unit : mm)

A Max	B Max	C Max	D ± 0.35	E Nom	F ± 0.2	G ± 0.3
10.0	see above table	10.0	2.5	4.5	1.1	1.0

**CURRENT VS INDUCTANCE:**

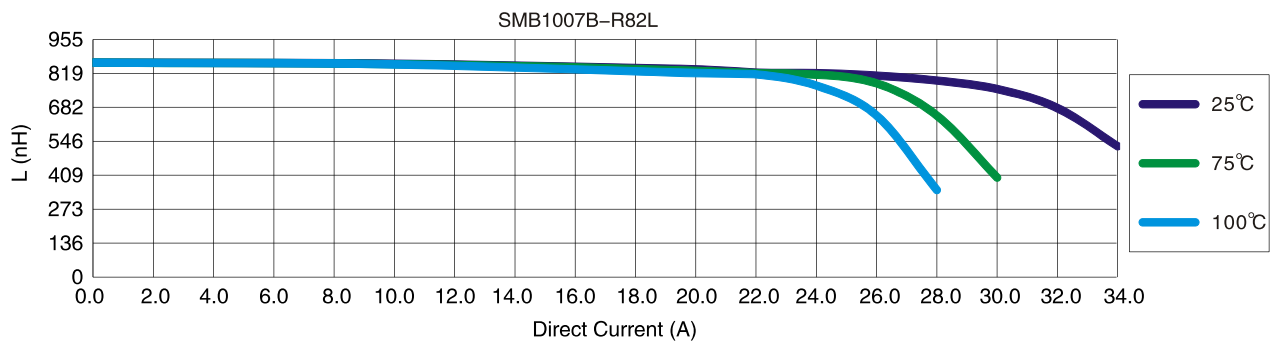
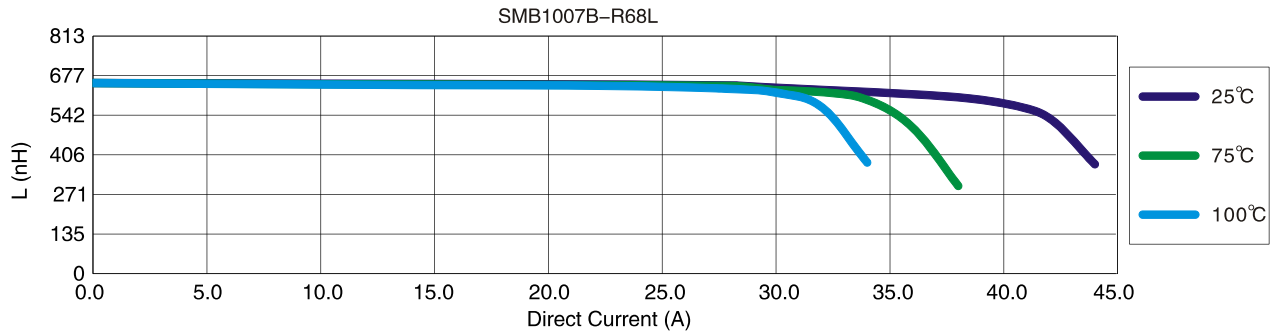
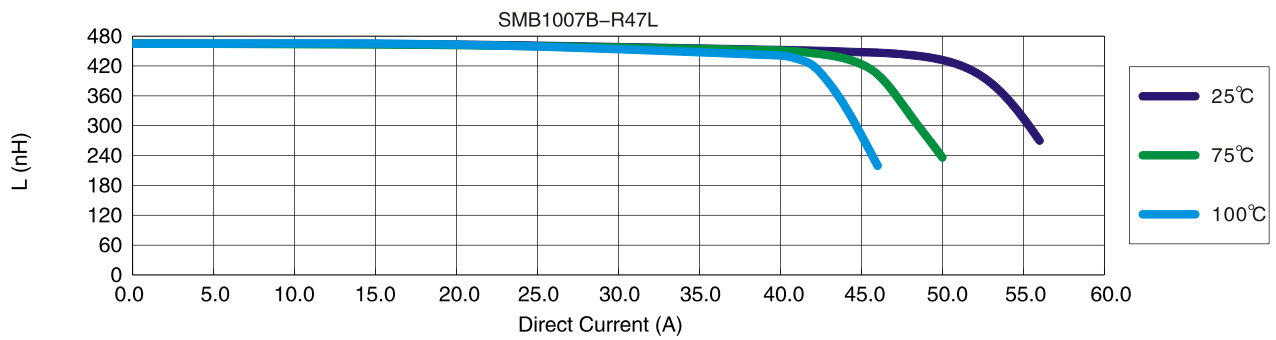
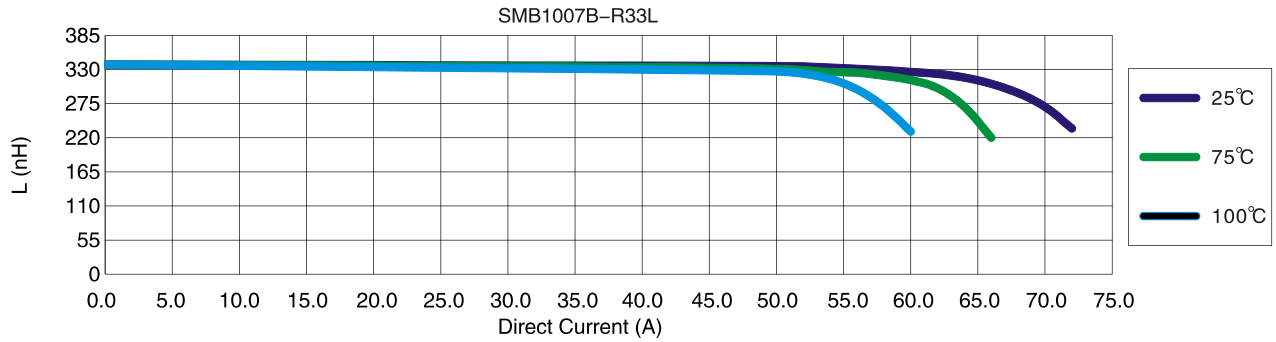

# CURRENT VS INDUCTANCE:

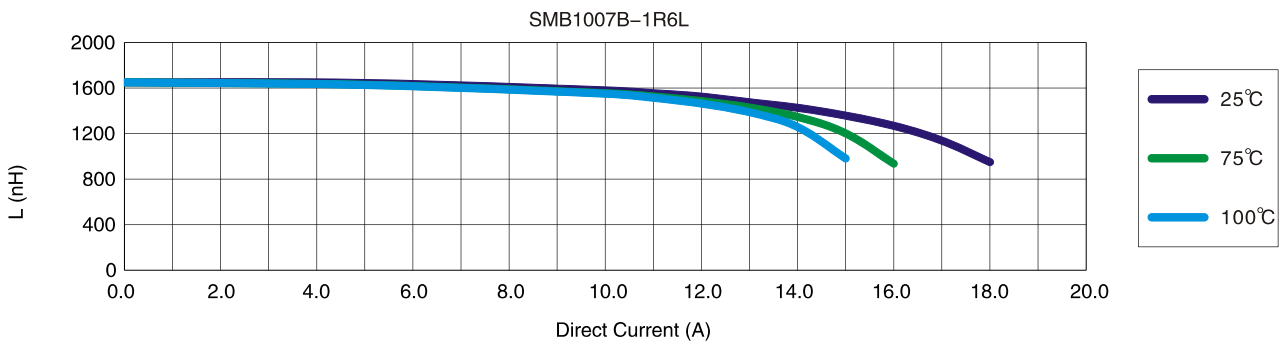
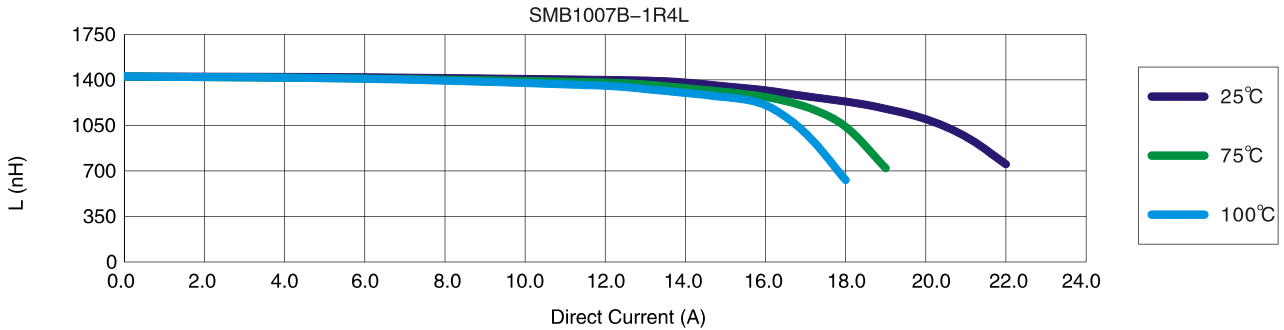
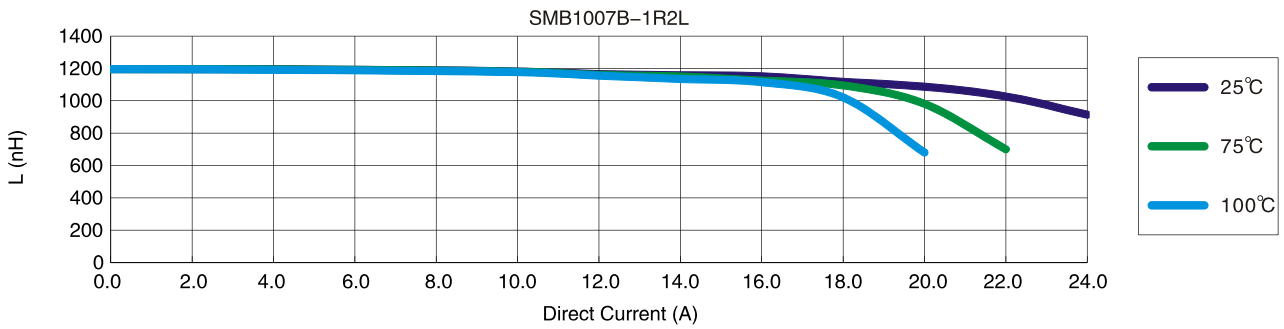
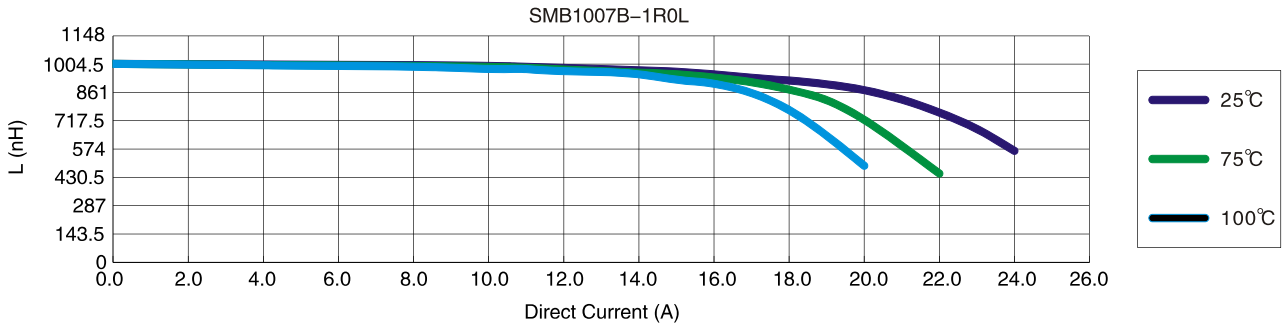

# SMD POWER BEAD

## SMB SERIEIS

### FEATURES

- \* Suitable for applications with Ultra High Current.
- \* High mechanical body.
- \* Stable characteristic.
- \* Operating temperature -40~+125°C (Including self - temperature rise)



### APPLICATIONS

- \* Computer products, mother board, TV card
- \* Power supplier, OA products, modem...
- \* Communications
- \* Countermeasures for complying with CE, FCC, VDE or VCCI radialiated emissions etc

### PRODUCT IDENTIFICATION

#### SMB - 853025 C - 101 Y

① Product Symbol		② External Dimensions (LxWxH)(mm)		③ Shape Code	
SMB	SMD Power Bead	322521	3.10×2.50×2.15	None	Bottom Flatness
		323023	3.05×2.90×2.20	C	Bottom hollow groove
		403022	4.20×3.00×2.20		
		403025	4.20×3.10×2.90		
		784730	8.00×4.70×3.20		
		853025	9.00×3.00×2.80		

④ Nominal Impedance		⑤ Tolerance Value	
Example	Nominal Value	M	±20%
400	400Ω	Y	±25%
101	100Ω		

### SHAPE AND DIMENSIONS(mm)

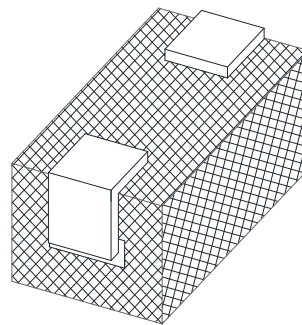
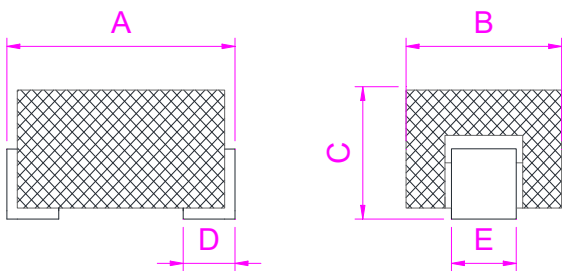

Figure 1

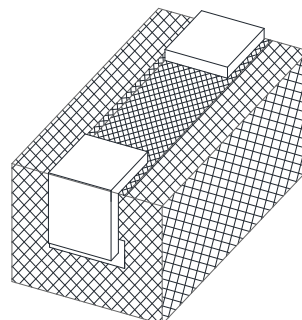
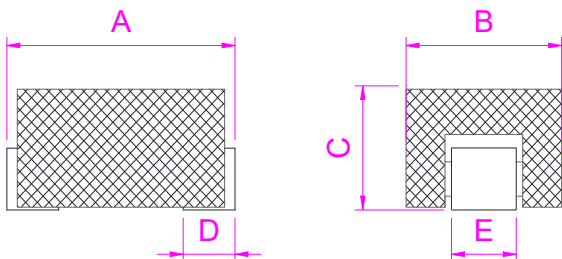
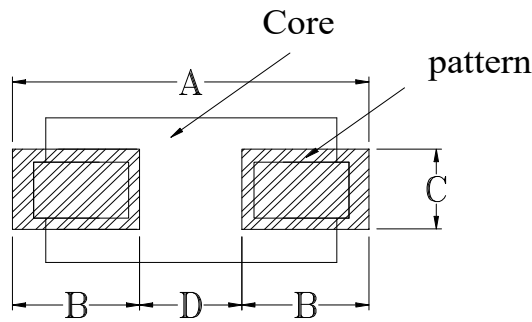

Figure 2

Part No.	A	B	C	D	E	Figure
SMB-322521C	3.20 max.	2.50±0.15	2.30 max.	0.85±0.20	0.70±0.10	2'
SMB-323023C	3.20 max.	2.90±0.15	2.41 max.	0.80±0.20	0.85±0.10	2'
SMB-403022C	4.80 max.	3.60±0.15	2.50 max.	1.30±0.20	1.25±0.15	2
SMB-403025	5.00 max.	3.10±0.15	3.10 max.	1.35±0.20	1.25±0.15	1
SMB-784730	8.80 max.	4.75±0.20	3.55 max.	1.45±0.30	1.25±0.15	1
SMB-853025C	9.40 max.	3.10±0.15	2.80 max.	1.45±0.30	1.25±0.15	2'
SMB-853025	9.50 max.	3.00±0.15	3.10 max.	1.45±0.30	1.25±0.15	1

**LAND PATTERN DIMENSIONS(mm)**



Part No.	A	B	C	D
SMB-322521C	4.20	1.50	1.50	1.20
SMB-323023C	4.20	1.50	1.50	1.20
SMB-403022C	4.80	1.40	1.50	2.00
SMB-403025	4.80	1.40	1.50	2.00
SMB-784730	10.50	3.00	1.80	4.50
SMB-853025C	10.70	3.30	1.50	4.50
SMB-853025	10.70	3.30	1.50	4.50

**ELECTRICAL SPECIFICATIONS**

Part No.	Impedance (Ω)		DC Resistance (mΩ) max. @25°C	Rated Current (A) typ. ΔT=40°C
	25MHz	100MHz		
SMB-322521C-350Y	25±25%	35±25%	0.60	14.0
SMB-323023C-408Y	23±25%	40±25%	0.60	15.0
SMB-403022C-400Y	28±25%	42±25%	0.60	15.0
SMB-403025-530Y	35±25%	53±25%	0.50	18.0
SMB-784730-980Y	65±25%	98±25%	0.90	18.0
SMB-853025C-900Y	65±25%	90±25%	1.00	17.0
SMB-853025-101Y	65±25%	100±25%	1.00	17.0

## TYPICAL CHARACTERISTICS CURVE

